

Systems science and system thinking in practice

How to develop qualitative and numerical models for evolving understandings of challenges and responses to complex policies

HÖRDUR VALDIMAR HARALDSSON AND HARALD ULRIK SVERDRUP

REPORT 6981 • APRIL 2021

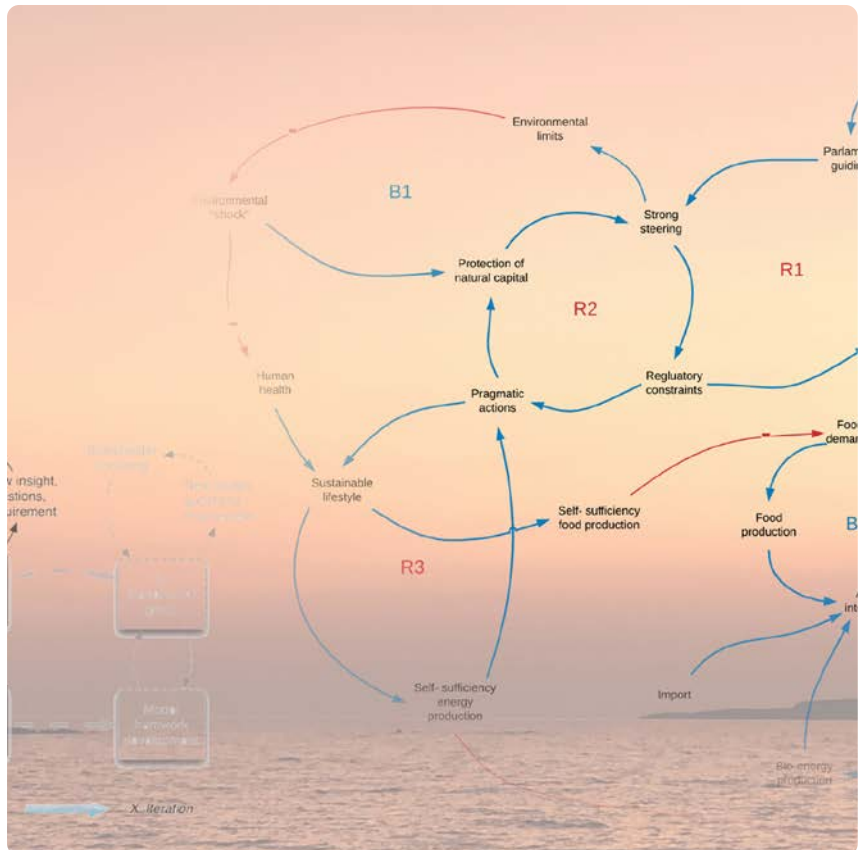
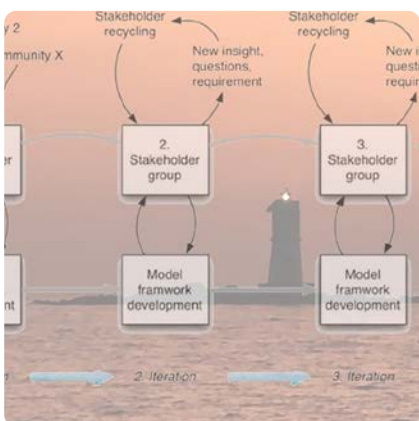
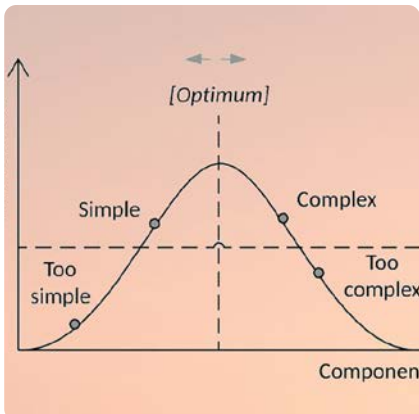

Systems Science and System Thinking in practice

How to develop qualitative and numerical models for evolving understandings of challenges and responses to complex policies

Hördur Valdimar Haraldsson
Harald Ulrik Sverdrup

SWEDISH ENVIRONMENTAL
PROTECTION AGENCY

Order

Phone: + 46 (0)8-505 933 40

E-mail: natur@cm.se

Address: Arkitektkopia AB, Box 110 93, SE-161 11 Bromma, Sweden

Internet: www.naturvardsverket.se/publikationer

The Swedish Environmental Protection Agency

Phone: + 46 (0)10-698 10 00

E-mail: registrator@naturvardsverket.se

Address: Naturvårdsverket, SE-106 48 Stockholm, Sweden

Internet: www.naturvardsverket.se

ISBN 978-91-620-6981-0

ISSN 0282-7298

© Naturvårdsverket 2020

Print: Arkitektkopia AB, Bromma 2020

Cover photos: Author



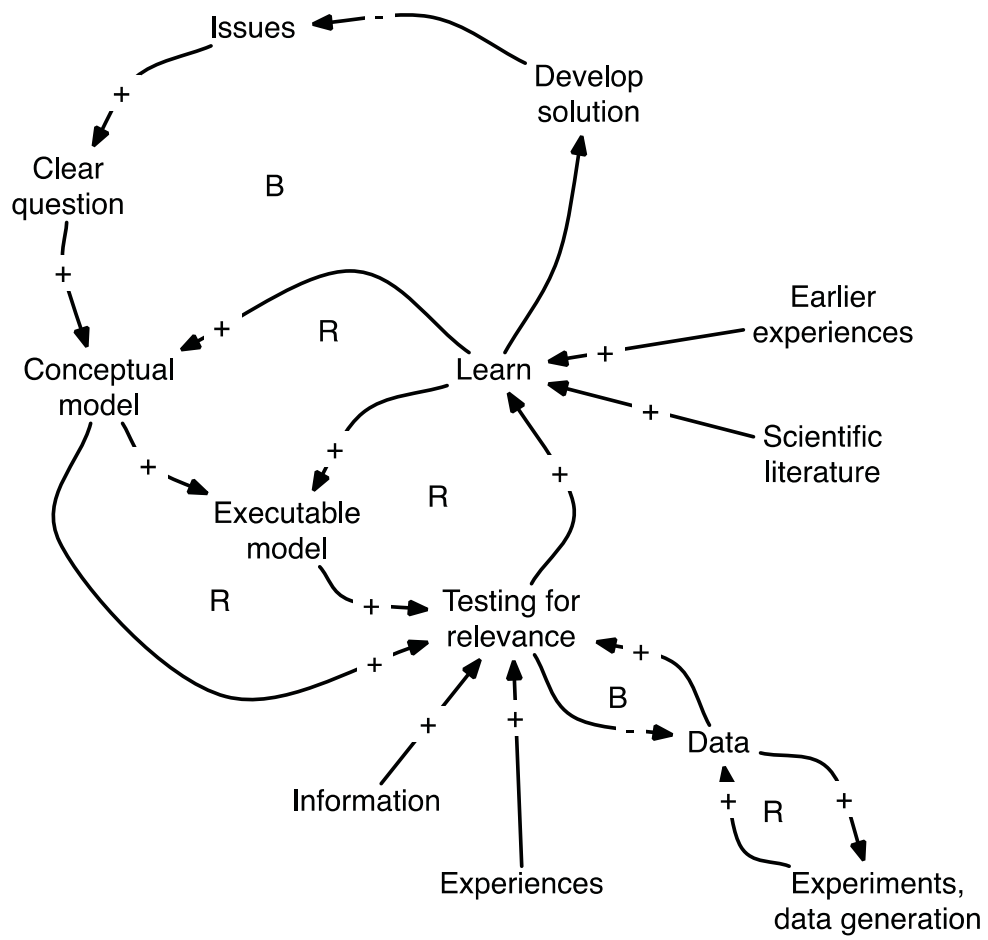

Preface (Förord)

The societal transformation to a sustainable future will require robust and well-founded policies. We live in a world that is constantly changing, which affects our ability to achieve our goals. Public authorities are faced with a myriad of challenges that exist on multiple levels where instructions, instrument designs, monitoring, planning, and implementation are all part of the complex policy cycle. This unique and demanding situation requires public authorities to possess a systematic understanding of their roles in providing accurate fit for purpose support and guidance to society at large as well as to policy makers. As the national authority responsible for environmental issues, the Swedish Environmental Protection Agency is a key player in providing guidance and support for the development of short- and long-term policy proposals. To meet the challenges of the future, we need to possess knowledge on how to read and understand complex systems and understand how to use that knowledge to make positive changes. This understanding comes through systems thinking and systems analysis approaches towards problem solving and solutions.

This publication describes and explains systems thinking and systems analysis for experts and non-experts, from policy makers to policy analysts. The authors, Hördur V. Haraldsson (Swedish Environmental Protection Agency) and Harald U. Sverdrup, (Department of Game Development, Inland Norway University of Applied Sciences) are responsible for the content.

Stockholm, 26 March 2021

Pontus Lyckman
Head of Knowledge Coordination Unit

Foreword by the authors

Agenda 2030 for Sustainable Development consists of 17 global goals for a better world. It is a plan of action for a sustainable future for mankind and our planet. At a national level, Sweden's environment objectives address the challenges that exist with respect to environmental sustainability. This publication addresses some of the challenging issues facing many public authorities in how to adopt systems thinking and systems analysis in their work. Many of the problems that public authorities deal with are similar in structure – i.e., problematizing issues, defining key questions, determining the scale and size of deliverables, and understanding what resources are needed to complete the work. Problems presented as singular issues are often linked through intricate feedbacks that require a systemic approach to finding solutions. At first glance, it is not always clear what the problem really is, as a problem can penetrate different parts of an organisation. These conditions can actually amplify a problem, making informed decisions difficult and requiring intensive resources. The challenges to public authorities often start in the pre-problem stage. At this stage, public authorities need to determine if there is really a problem that needs to be solved before committing resources. This determination can be done by answering several questions:

1. Can we form a clear question and frame for the problem?
2. Is there a clear question but an unknown frame for the problem?
3. Is there an unknown question as well as an unknown frame for the problem?
4. Once clarified, do we have the resources to address the problem?

Using this approach to investigate an issue, authorities can define the problem and identify challenges and the process needed to build actual solutions.

This publication lays out a systematic approach to problem solving on a basic level by illustrating how to approach complex task using two main processes:

1. A qualitative approach – i.e., building a mental understanding of the problem; and
2. A quantitative approach – i.e., building a numerical understanding of the problem.

Although both approaches are necessary, how the question is formulated and the accuracy of the answer required determines the sophistication of the analysis needed. In addition, this publication highlights the importance of group model building and shared ownership of problems and solutions. For public authorities, this is essential as it creates transparency, legitimacy, and acceptance for policy design. Some problems require in-depth data analysis and statistical methods which are not covered here.

This publication is written for laypeople, so the examples (i.e., case studies) used are easy to understand. The case examples demonstrate the processes required for defining a problem and creating solution(s) – i.e., systems thinking and analysis. Understanding systems thinking, system analysis, and system dynamics will provide public authorities and organisations the flexibility and agility to quickly adapt to a changing society.

Dr Hördur V. Haraldsson, Swedish Environmental Protection Agency.
Stockholm, Sweden.

Professor Harald U. Sverdrup, Game Development and Interactive Simulations,
Inland Norway University of Applied Sciences. Hamar, Norway.

Acknowledgement

The publication is a collection of texts that have been written over several years by the authors. Some concepts on theory and practice presented here were developed by Haraldsson (2005) and the work further developed through the experience of practical work in educational institutions and government agencies. The text has gone through several updates and benefited from accumulated insights and suggestions from various people. The authors would like to thank the following people for their contributions to this text: Dr Salim Belyazid, Physical Geography, University of Stockholm; Dr Deniz Koca, Lund University; and Dr Anna Hulda Ólafsdóttir, University of Iceland. Furthermore, the authors would like to express their gratitude to Ullrich Lorenz, Umweltbundesamt (UBA) Germany for valuable feedback and discussions and Lisa Eriksson at the Swedish Environmental Protection Agency for making this publication possible.

Contents

1	SYSTEMS THINKING	13
1.1	Introduction	13
1.1.1	Why are systems important?	13
1.1.2	The pedagogical purpose of this text	13
1.1.3	Why models?	14
1.2	General methodology: Starting with the problem or mission statement	17
1.2.1	Conceptualisation: Systems analysis	17
1.2.2	Data: How to use information	19
1.2.3	Computational method: System dynamics	19
1.2.4	Validation and performance testing: More on data	20
1.2.5	Attitudes and purposes in research	20
1.2.6	Group model building	20
1.3	System Science and Theories	22
1.3.1	Systems thinking, systems analysis, and system dynamics	22
1.3.2	A brief history of system science	24
1.3.3	The development of System Science	28
1.4	Introduction to systems and models	31
1.4.1	System boundaries	31
1.4.2	Model use and components	36
1.4.3	Model properties and performance	37
1.4.4	Simple vs. complex models	40
1.4.5	Performance vs. complexity in model components	41
1.4.6	System levels and scales	43
1.4.7	Understanding delays	46
2	SYSTEMS ANALYSIS	48
2.1	Introduction	48
2.2	Drawing a causal loop diagram	48
2.3	Reference behaviour pattern (RBP) and observed behaviour pattern (OBP)	55
2.4	Delays	57
2.5	Loop analysis	58
2.5.1	Analysing the loop behaviour of conflict using RBP	67
2.5.2	Analysing the loop behaviour of riding a bicycle	69
2.5.3	An example: Analysing the loop behaviour of the Mouse Empire	71
2.6	Working with the CLD and flow charts	73
2.6.1	Seeing the Learning Loop	73
	Advice on how to phrase the CLD and avoid pitfalls	77
2.6.2	A short introduction to flow charts	78
2.6.3	An example: Analysing the behaviour of the dog and the man	81
2.6.4	Formulating goals and objectives and success	85
2.6.5	Summarising mental modelling	88

2.7	Exercises: Practising CLD and RBP	89
2.7.1	The running girl	89
2.7.2	The urbanisation of south Fantasia	91
2.7.3	The hydro dam in Mos Eisley	92
2.7.4	Mining minerals in Antarctic	92
2.7.5	Mars, the next frontier	93
2.7.6	Gaia and climate change	93
2.7.7	The traffic problem in Malmö City	94
2.7.8	The polluted lake in Duncan	96
2.7.9	Three Gorges Dam	97
3	THE SYSTEM DYNAMICS MODELLING PROCESS	100
3.1	Understanding	100
3.2	The System dynamics modelling process	101
3.3	Reworking the modelling procedure	102
3.3.1	Define the problem and create system boundaries	103
3.3.2	Ask the question	104
3.3.3	Sort the main actors	106
3.3.4	Start a CLD and/or SFD model	107
3.3.5	Create an RBP and OBP	108
3.3.6	Test the CLD and the SFD model	108
3.3.7	Learn and revise	109
3.3.8	Conclude	110
3.4	The learning process	110
3.4.1	The learning loop	110
3.4.2	Building a numerical model as a secondary step to mental models	111
3.5	The extended learning loop and the innovation process	114
3.5.1	The extended learning loop model	115
3.6	Group modelling: The four innovation phases	117
3.6.1	Definition phase	117
3.6.2	Clarification phase	118
3.6.3	Confirmation phase	118
3.6.4	Implementation phase	119
3.7	From conceptual to mathematical model	120
3.7.1	From CLD to simulated SDTD model – the workflow	123
3.7.2	Building a simulation out of CLD – An example from Iceland	130
3.7.3	Testing performance, DT, and uncertainties	130
3.7.4	Take home lesson	133
4	BUILDING SIMULATION MODELS IN CASE STUDIES	134
4.1	The bank account and my money	134
4.2	The economics of the apple cider business	141
4.3	The lonely planet: Easter Island	152

5	UNDERSTANDING SOME CASE STUDIES	179
5.1	Interpretations	179
5.1.1	Example 1: Measuring performance. Eco-living vs. Conventional living	179
5.1.2	Example 2: The Icelandic vegetation dynamics and carrying capacity	181
5.1.3	Example 3: The generic archetype – Tyranny of small steps	185
5.1.4	Example 4: The Hallormstaður project – The Innovation process	189
5.1.5	The modelling procedure and the group Innovation process.	192
5.1.6	Example 5: Exploring drivers of unsustainability with Systems analysis	194
5.2	Using causal loop diagrams for policy analysis	211
5.2.1	The example of agriculture	211
5.2.2	The example of population size, women’s rights, and the society	212
5.3	Standardised solutions	216
5.3.1	Applying generic structures and problems with best practices	216
5.3.2	The risks associated to model packages	218
	APPENDIX 1: DIAGNOSTIC QUIZZES	220
Quiz # 1	Using CLDs	220
Quiz # 2	From CLD to SFD	223
Quiz # 3	Make the connection and illustrate causalities	225
Quiz # 4	From Narrative to analysis – Fuelling the future, charcoal in Chad	226
	APPENDIX 2: GLOSSARY OF TERMS	230
	REFERENCES	240

1 Systems Thinking

1.1 Introduction

1.1.1 Why are systems important?

Systems science is the science of System Thinking, System Analysis, and System Dynamics. The essence of systems science is understanding causal relationships and feedback. Understanding a cause and an effect enables us to analyse, sort, and explain how changes come about under certain conditions. Using this analysis, systems science can construct complex computer models. However, computer modelling is no longer restricted to skilled programmers; it is a readily available tool accessible to everyone. Recently, computer model building has shifted from requiring programming skills to understanding how to sort (i.e., define) a problem. That is, lack of information is no longer the limiting factor when building models, but lack of capacity to sort out the relevant information is. Furthermore, constructing complex models is becoming increasingly important since building and maintaining such models can be time consuming and expensive. Models may take years to develop and therefore the thinking that informs the models must be transparent and testable so the work can be justified.

As we live in a complex world and a very complex society, understanding events, processes, and connections (with or without presence of confounding factors) is more important now than at any other time history. Today, there is a tendency to emphasise big data and data collection, although more data does not necessarily mean better understanding. More data could just mean more noise; the key to understanding is finding the signal in all the noise. Understanding systems requires understanding how causalities are linked, so understanding these links can explain how and why things happen. Big data without a translator, a method of interpreting what we observe, is merely noise. Large amounts of information require a system that can identify the signal – i.e., useful information or information that can be used to define and/or solve a problem, connecting the noise to a signal and its underlying patterns. Making these connections is what systems thinking does.

1.1.2 The pedagogical purpose of this text

This publication is intended for public authorities as well as academics. The text provides theoretical discussions, practical examples, project examples, and exercises. As this publication is meant to be as useful as possible, the chapters are designed to be self-contained units. That is, readers can use the text as a reference when they need a methodological approach to solving a problem. In addition, the organisation of the publication is designed for self-study, allowing readers to learn at their own pace. Throughout the text, the use of the concepts, variables, parameters, items, and factors, are used interchangeable to describe the components and structure of a model. Generally, items, and factors, have non-defined properties, whereas the terms, variables,

and parameters, are generally associated with quantification and are further development of a structured conceptualised model, as illustrated in examples in the text. A glossary of terms that are used throughout the text is found in Appendix 2.

1.1.3 Why models?

What are models and why do we create models? A model is any conceptual understanding of a phenomenon, event, or connection that can be used to evaluate cause and effect. Because the properties of models vary depending on the purpose of the research, it is necessary to define what constitutes a model. A model is a simplified representation of real world phenomena and the consequence or interpretations as the result of a set of observations or experiences. Here, models are first and foremost mental models, a conceptual understanding of a system that in a continuation phase can be converted into mathematical models. Many problems in natural systems may be so complex – i.e., non-linear and multi-dimensional – that their solutions require a non-linear approach. However, simplifications of complexity are often linear, and linear correlations poorly define causal relations of complex systems. Linear approaches to complexity require complex explanations of a problem, obscuring the fundamental aspects of a problem. That is, linear approaches to model construction tend to focus on the variables and the input data rather than understanding, the original purpose of a model. You know when you are dealing with linear approaches when you hear comments such as these:

The interaction with the ecosystem is determined by an unknown feedback and therefore we cannot understand it.

There are thousands of factors affecting . . .

It cannot be observed, but it is very important for . . .

Well, it is always different in the real world, so it is impossible to try to explain it.

In reality, such comments are always false. What the speakers of these comments really are saying is ‘I do not want to try’ or ‘I do not have the ability to try’. Models help make the connection between causes and effects that are first formed as mental impressions. That is, the real models exist in our heads, so what we put on paper or in computers are only representations of our mental models. The models we make in our heads are largely coloured by our cultural and educational background. Thus, the messages sent through language contain specific information as well as associative information shared by a community of speakers. This is a very efficient way to communicate as much of the information in a message is implied, requiring no further explication because the speaker and listener share the same linguistic and cultural associations. Moreover, people who tend to make similar associations tend to feel connected.

Let's take a very simple example (Figure 1.1). Look at an apple that has fallen to the ground. Depending on who we transmit this image to, they will make different associations.

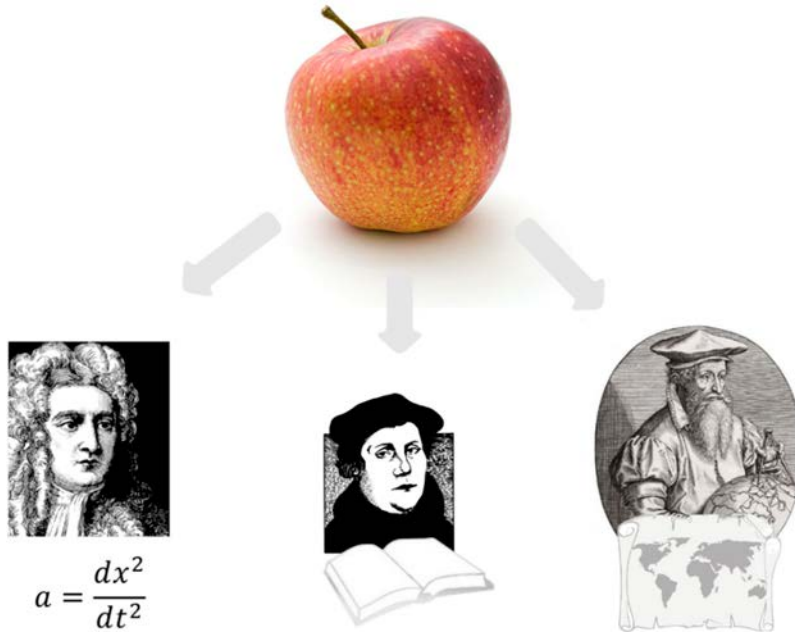

Figure 1.1. Different people from different backgrounds make different associations and therefore form different internal mental interpretations. We must remember this when we explain complex systems.

Newton, at least on one occasion so the story goes, may have associated an apple with a force called gravity and the law of accelerations in a force field. He translated this experience into an equation, the normal language for him for such things. However, Martin Luther, a religious leader of the Reformation, may have associated an apple with the story of the fall from Paradise. Similarly, Gerardus Mercator, a 16th century cartographer, may have associated an apple to his apple orchard at his summer house in Friesland. The man was after all, a cartographer.

People understand simple descriptions of an object such as an apple differently depending on their psychological state and cultural context although they often assume their understanding of the description of the object will be the same as everyone else's understanding. Therefore, mental models always need to be explicitly shown to ensure the sender and receivers of a message (i.e., the sender's mental model) share the same understanding of the message. Viewing language as a mind map can be quite revealing.

Systems analysis is the art of finding things out, and as such, finding things out applies to all knowledge creation. For many systems, it may appear as if the causal changes and connections are obvious; however, most of the time, there are no drawings or construction plans, so we have to find these causal changes and connections ourselves. Look at the photograph of a winter landscape in the Bydalen Mountains in Sweden (Figure 1.2). This landscape is

actually a complex system characterised by ecological, chemical, and physical change. Mix in a human interaction and the picture becomes even more complex.



Figure 1.2. A view of the Bydalen Mountains recreational/nature reserve area in Sweden. In a natural systems, the causal links are not always self-evident.

How do the harsh winter conditions affect the vegetation and the underlying soil chemistry? How will long-term climate change affect the evolution of this ecosystem and its recreational use in the future? To answer these questions, you need to conduct a systems analysis of the problem, often as a pictorial representation of the interacting features in the system. There is no office where an existing drawing is kept, there is no drawing anywhere, so you need to construct one, from details, books, articles, and experts. Systems analysis will allow you to put the puzzle together. In a systems perspective, there is no limit to finding things out; the limits that you invent for yourself, those of your own device, are the problem.

One important outcome of systems analysis is the ability to do systems dynamics. After finding things out, we can organise and put together the relevant information to create a model and check if the model predicts what we observe. If it does, we can make predictions or backcast from goals to determine what measures are needed. The design also sets the premises for how we measure success. If we determine that the goal is to eliminate certain unwanted conditions, then the success is defined as the absence of these unwanted conditions. The distance to target is then the difference between the current conditions and desired conditions. This is illustrated in Figure 1.3. Here, the causal chain involves going from industrial pollution to effects on terrestrial ecosystems. The pollution is produced within our infrastructure, such as power plants and cars. The gasses emitted are transported by wind to places far away (arrow between emissions and deposition). Deposition is the process by which airborne particles deposit themselves on a surface. When the deposition interferes with the ecosystem, effects will appear.

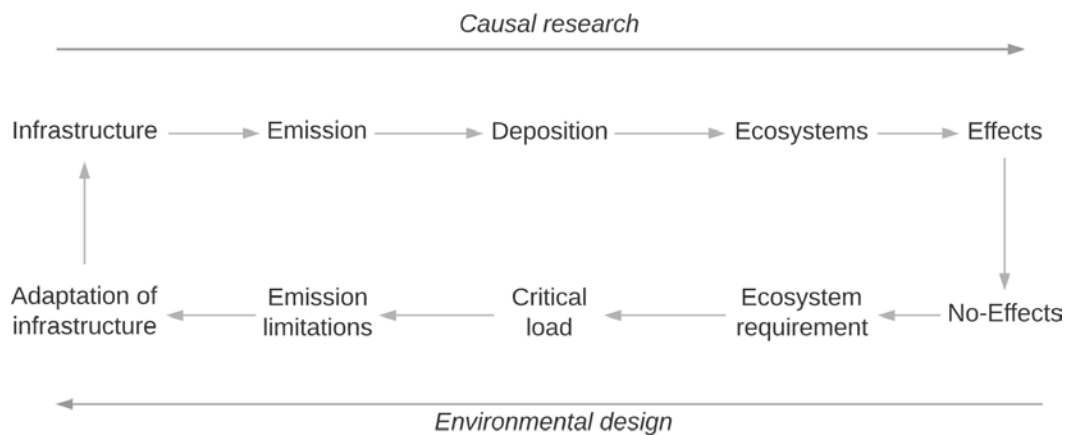

Figure 1.3. How to backcast from current conditions to desired conditions. The process goes from defining a problem, to defining the goal, and to defining measures needed to successfully reach the goal.

If success is defined as atmospheric pollutant deposition below a certain limit, we need to define the constraints on emissions, which ultimately will lead to decisions about how to design and use infrastructures that will constrain emissions. Backcasting is design of the upfront causal end of the system to satisfy a backend requirement. In addition, systems dynamics considers time as planning necessarily involves aspects of the future. Defining success always includes framing goals and the desired state because it provides idea about how the blueprints for interventions look like over time and on what level.

1.2 General methodology: Starting with the problem or mission statement

The methodology for modelling follows the order of events shown in Figure 1.4. Modelling always starts with a precise statement of the problem, which is followed by a conceptualisation. The methodology used here uses systems analysis as the standard tool for conceptualisation. Irrespective of computational method, the modelling must be preceded by the conceptualisation step. The order of working follows this learning loop, starting with the problem (Figure 1.5).

1.2.1 Conceptualisation: Systems analysis

The main tools employed are the standard methods of systems analysis and system dynamics modelling (Roberts et al., 1982, Haraldsson 2005, Haraldsson and Sverdrup 2005, Haraldsson et al., 2006, Forrester 1971, Meadows et al., 1972, 1992, 2005, Senge 1990). The real model depicts the system dynamics, and the mental model and systems analysis is used to develop this real model. We analyse the system using stock and flow diagrams (SFD) and causal loop diagrams (CLD). The learning loop is the adaptive learning procedure followed in our studies (Senge, 1990; Kin, 1992; Haraldsson and Sverdrup, 2003;

Senge et al., 2008) (Figure 1.13). The conceptualisation is where the actual model is developed. The model is the bearer of the knowledge employed and must be completely clear before any computational work can be undertaken. This is key: the causal understanding is the model. Systems analysis produces system mapping in terms of causalities (Causal loop diagrams; CLD) and flows (Flow charts; FC). Together, CLD and FC define the causalities and flow paths and ultimately the structure of the system. These system maps need to be internally consistent and constitute the design plans for the computational system used. CLD are used to map the causalities, to find intervention points, and to propose policy interventions.

The three fundamental steps of modelling

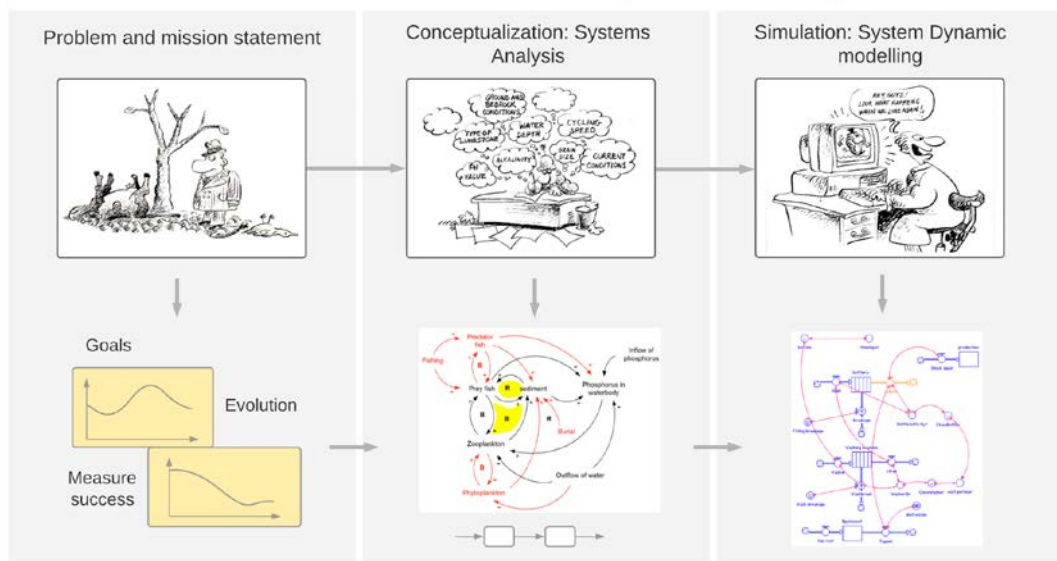

Figure 1.4. The fundamental steps of any modelling.

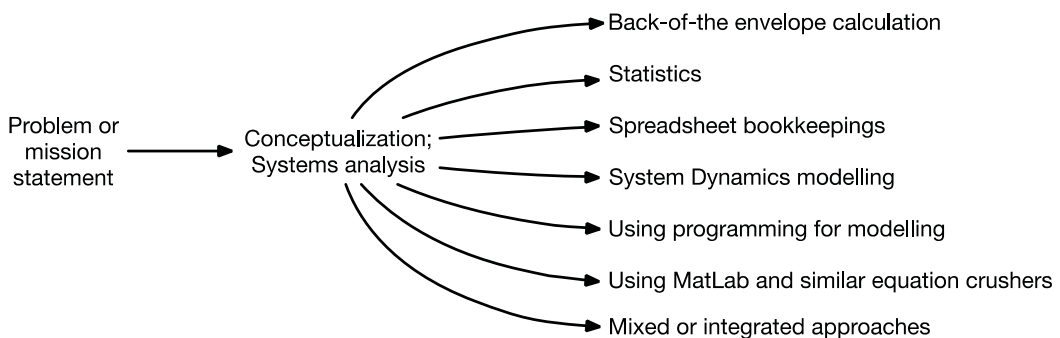

Figure 1.5. Modelling always start with a precise statement of the problem followed by a conceptualisation. The methodology uses systems analysis as the standard tool. Irrespective of computational method, the modelling must be preceded by the conceptualisation step. Many problems in teaching modelling in universities comes from a faulty or missing conceptualisation pre-stage before using software.

1.2.2 Data: How to use information

Data enter the procedure late in the process (Figure 1.6). Data comprise numbers that quantify system states, changes, and sizes as well as structural, contextual, and qualitative information. If data collection takes place before the statement of the problem and conceptualisation, then the data search will be random and most of the effort will be wasted. Such a random approach will eventually require stopping the process until a useful statement of the problem can be formulated. Data collection occurs simultaneously with the construction of the computation systems. Note that the formulation of the problem and conceptualisation need to take place irrespective of computational method, including back-of-the-envelope calculations or using statistics packages.

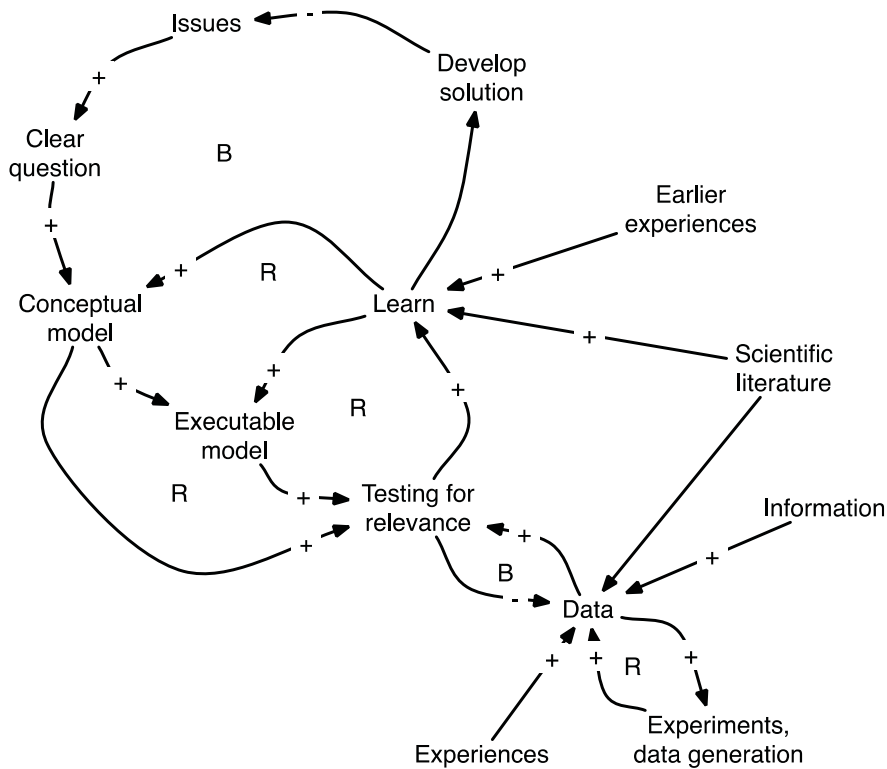

Figure 1.6. The learning loop is the adaptive learning procedure followed in our studies (Senge 1990; Haraldsson and Sverdrup, 2003; Senge et al., 2008).

1.2.3 Computational method: System dynamics

The computational method uses high-level graphical modelling programs such as STELLA (ISEE Systems). The entering of the code (in modelling programs) follows from the causal loop diagrams and flow charts developed in the conceptualisation stage. The software tools have no conceptualisation power as the computational modelling carries out calculations only according to the instructions derived from the conceptual model. The mass balance expressed as differential equations resulting from the flow charts and the causal loop diagrams are numerically solved using STELLA (Sterman 2000, Senge 1990,

Senge et al. 2008, Haraldsson 2005, Haraldsson and Sverdrup 2005, 2017, Sverdrup et al. 2014a,b, 2015a,b, 2016a,b).

1.2.4 Validation and performance testing: More on data

After collected, the data are divided into five categories:

1. System boundary and initial conditions;
2. System structures;
3. System parameter settings;
4. System states as quantitative estimates; and
5. System histories, narratives, and chains of observed events.

Categories 1–3 are used to parameterise the model before the simulations start. The state data (4) and the system histories, narratives, and chains of observed events (5) are not used initially but are saved and used for evaluation of model performance. A major feature is to map how well the embedded understanding actually reproduces the observed development in systems states and to identify where the actual deviation provides important information. Extensive calibration of parameters is not intended to obtain a maximum likeness of the system outputs, as is sometimes done with calibrated statistical models.

1.2.5 Attitudes and purposes in research

Attitude is important as many limitations are self-imposed, resulting from one's own attitudes. Furthermore, generalisation is necessary (i.e., letting go some details) to distinguish between what is important and what, is unnecessary. However, letting go of details is often difficult due to pressures to include these details not because they are needed, but because they are deemed important for reasons outside the systems analysis process, such as social, work, or even ideologically reasons. That is, systems analysis tends to evaluate everything for its value to produce (or re-produce in the case of ideology) a specific effect or result.

1.2.6 Group model building

An important instrument in systems analysis is the group modelling processes (also called participatory process) (Figure 1.7), which is an instrument that does several things at once:

- It checks that the mental model and associated pictures in our minds are compatible.
- It combines the skills, knowledge, and intelligence of the participants, surpassing what an individual could do working in isolation.
- It increases the efficiency of the scrutinising of the proposed models.
- It creates a social network and builds social trust within the group.

Group model building is not autogenerated by collecting people in a room as it requires skilful and careful management. If it fails, the group will be more incompetent than the most incompetent member in the group; if it succeeds, the intelligence, skills, and knowledge of the collective are additive and the group will be much smarter than its smartest member. Systems analysis requires seeing issues from other people's perspectives. It is more the rule than exception that group modelling results in new insights that challenge conventional wisdom, paradigms, and ideologies.



Figure 1.7. A causal loop diagram for working in a team. The left side is always done by a group. The right side can be done by a single individual.

The group must do the process illustrated in Figure 1.7 as a single entity – i.e., together. This group process results in a common language consisting of causal loop diagrams, loop analysis, qualitative response patterns, flow charts, and system dynamics graphical tools. Experience shows that this approach helps calibrate variance of mental pictures and models among group members so that they are perceived similarly by all members of the group. This group process generates social trust among the members when the results and outputs from the systems analysis are carried forward (Figure 1.8).

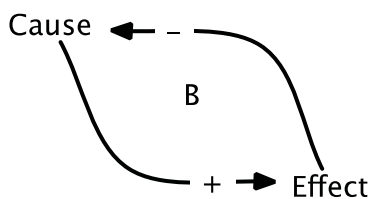

Figure 1.8. A simple causal loop diagram with a positive forward loop and a backward causal link, limiting the cause.

Generally, however, something seemingly counterintuitive emerges – i.e., some new side effect or chain of loops in the system are discovered. It often looks rather like Figure 1.12 than the causal loop diagram in Figure 1.7. Another effect may be the result of several things happening in parallel. As a result, some members of the group might need to rethink how the world works. As reconceptualising one's view of the world is difficult and places one in a vulnerable position, group members must trust that the other participants do

not have hidden agenda and will give them the time to adjust their thinking to new views. This robust process can uncover surprising results. When this milieu is established, people often express gratitude that the other members of the group helped them change their minds. If you cannot cope with having to change your mind, repeatedly changing your opinion, then you will have difficulty with systems analysis (Figure 1.9).

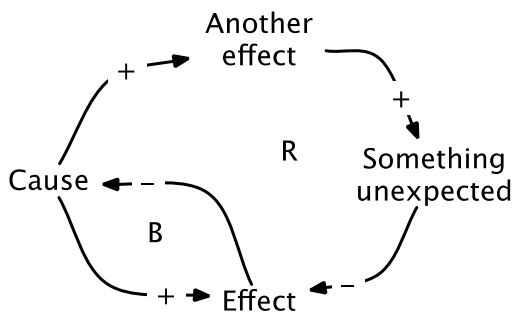

Figure 1.9. The causal loop in Figure 1.8 – after we have thought about an experience.

1.3 System Science and Theories

1.3.1 Systems thinking, systems analysis, and system dynamics

Systems science is the science of System Thinking, System Analysis, and System Dynamics, and the essence of systems science is understanding causal relationships and feedback loops. Understanding cause and effect enables the sorting out and explanation of how changes come about under certain conditions. Tools are now available that can construct and simulate complex model structures derived from analysis through systems science (Figure 1.10).

Computer modelling is no longer restricted to skilled programmers or engineers; it is a readily available tool that anyone can learn to use. Moreover, the new software makes computer modelling enjoyable as it all but guarantees anyone can master its use. Therefore, model building no longer requires advanced programming skills. That is, when building models, lack of capacity to sort out the relevant information is the limiting factor rather than a lack of computer programming skill. Furthermore, constructing complex models is becoming increasingly important since building and maintaining such models can be time consuming and expensive. Models may take years to develop and therefore the thinking behind them must be transparent and testable for the work to be justified (Figure 1.11).

Systems science deals with the organisation of logic and integration of disciplines to uncover and understand patterns in complex problems. Systems science, also known as principles of organisation or theory of self-organisation, involves systemic or holistic thinking based on understanding connections and relations between seemingly isolated events or things. System thinking (ST), the collective term for systems science, embeds two other concepts: System analysis (SA) and System dynamics (SD) (Figure 1.10). In general

terms, System thinking is the science of structuring logic and determining relevant questions, but it has practical applications through System analysis and System dynamics (Figure 1.13).

System thinking is a mind-set or philosophy about whole worlds rather than symptoms or sequences of event. Inherent in this is the identification of systems of causalities that give rise to events and histories. System thinking requires a willingness to take an eagle's view to define the boundaries of a system and ultimately to communicate these boundaries in an understandable and useful way. System analysis takes apart these whole worlds to uncover causalities, to detect and discover their structural arrangements, and to identify the effects emerging from the flows and accumulations from the causalities acting in the systems. System dynamics uses the results of System analysis to reconstruct the system of causalities. System dynamics (Forrester, 1961) involves assessing the performance of reproducing the events and histories of the system and to use this assessment to predict future behaviour (Figure 1.11).

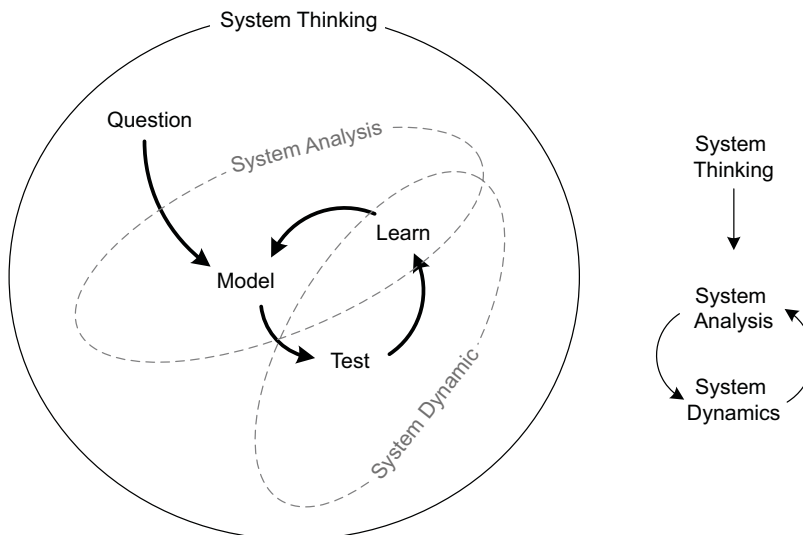

Figure 1.10. Properties of a system can be learned through System thinking, which involves a structural analysis (System analysis) and reconstruction (System dynamics). Discovering, participating, and reconstructing are the essence of systems science. Newton described whole systems with mathematics.

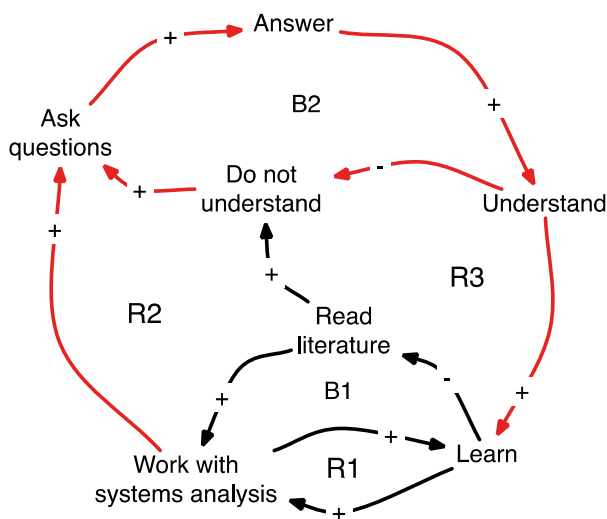

Figure 1.11. The learning loop also involves asking the group members or in the case of a student in the learning process, the teacher or the supervisor. Note how learning alone often creates a build-up of questions that either must be cleared with the group members in a group modelling session or with a teacher.

All models, in the form of written text, conceptual or mathematical, inherently rely on system thinking, since they are built according to certain thinking and logic. A model is successful when the thinking behind it is successfully transferred from the model builder to the observer. A model that does not adequately explain its principles is essentially flawed. Therefore, the model builder and the model user must rely on a common language to facilitate the understanding.

1.3.2 A brief history of system science

The idea of the world as a system was present in antiquity, with thinkers like Plato and Epicurus. In *De rerum natura* (*On the Nature of Things*), the Epicurean poet Lucretius (c. 99 BC – c. 55 BC) claims that effect always follows cause and that all existence seems to be connected in this way. However, it took Newton (1643–1727), in *Philosophia naturalis principia mathematica* (*Mathematical Principles of Natural Philosophy*) (1687), to formulate Lucretius' understanding of cause and effect into systems theory. This revolution set off a movement of using mathematics as the prime language of system analysis (Figure 1.12

Feedback means response to an action or inverse flow of influence in regard to an action. Feedback is responsible for changes within systems, i.e., action causing reaction. It is any action that causes an effect back to the starting point of the action. Feedback is thus both the cause and the effect. (Haraldsson, 2004)

The concept of System dynamics stems from thinking that developed during the 1920s in several disciplines simultaneously (Capra, 1997). In the natural sciences, Alexander Bogdanov formed a first comprehensive theoretical framework on organisation of living and non-living systems. In physics,

Werner Heisenberg developed the uncertainty principle, which became an early documentation about systems.

In the early days of chemical engineering (Walker et al., 1923), 'boxes' and 'arrows' were used to map fluxes and rates and to illustrate properties of a system. Norbert Wiener (1961) used the concepts automatic control, feedback systems, and systems modelling to build systems for radar guidance of anti-aircraft guns during the Second World War (Churchill, 1948). This led him to important systemic insights concerning feedback systems and how they can be used and understood. In 1961, he published these insights under the label of cybernetics (i.e., the science of communications and automatic control systems) (Wiener, 1961).

What is a system? A system is a network of multiple variables that are connected to each other through causal relationships that express a behaviour, which can only be characterized through observation as a whole. The principal attribute of a system is its dynamic behaviour and interaction that can only be understood by viewing it as a whole. (Haraldsson, 2004)

Ludvig von Bertalanffy was first to synthesise this new knowledge into a new concept which he called 'general systems theories'. Bertalanffy made it clear that system theory was a science of wholeness that guarded against superficial analogies in science (Bertalanffy, 1968). With the development of the general system theories, the cybernetic movement emerged. This movement, formed after World War II, was developed by a group of mathematicians, neuroscientists, social scientists, and engineers, led by Norbert Wiener and John von Neumann.

They developed important concepts about feedback and self-regulation within engineering and expanded the concept of studying patterns, which eventually led to theories of self-organisation (Nicolis and Prigogine, 1977; Rosnay, 1979; Lagerroth, 1994; Capra, 1997; Connor and McDermott, 1997). Perhaps one of the most significant discoveries made by system thinkers was the fact that all sciences are in principle non-linear. The Neumann group discovered an important feature of System thinking: the ability to shift attention back and forth between details and wholeness through different levels (system levels) and observe how different principles work within each level of a system (Weinberg, 1975).

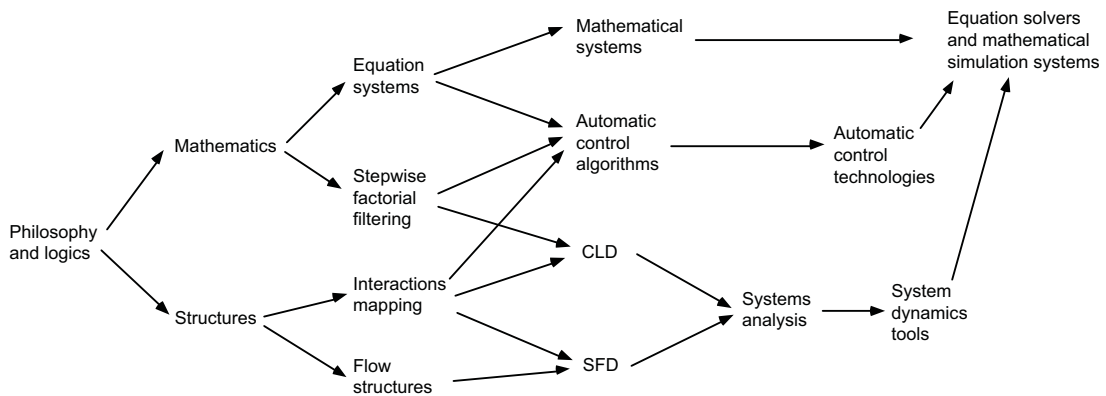

Figure 1.12. The history of System analysis and System dynamics as it emerged from the evolution of philosophy and logics in parallel with mathematics leading ultimately to software for System dynamics, automatic control, and mathematic systems solvers. System dynamics tools provide a good point of departure for stepping back into high-performance mathematical equation solvers.

The term System dynamics was first used in the 1960s at the Massachusetts Institute of Technology (MIT) when research into complex business behaviour began (Forrester, 1961). At this time, industry wanted to understand how to deal with unexpected behaviour of price fluctuation and its coupling to supply and demand. The 1960s saw some interesting developments within System dynamics. People started to combine efforts from different disciplines such as engineering and business. Forrester was a pioneer in his work on industrial and urban dynamics and helped develop many of the basic concepts used in System dynamics. Forrester's models mainly focused on growth and decay of urban systems through economic mechanisms such as industry, employment, and housing (Forrester, 1969). Other studies on similar principles followed (Barney, 1974; Alfeld and Graham, 1976; Alberti, 1999) that described urban systems as a dynamic interactions between socio-economic factors and natural resource use principles. Similarly, the environmental movement of the 1960s and later raised many questions that required trans-disciplinary investigations. The environmental movement identified many complex problems that integrated economy and resource management and emphasised the need to address them as a whole (Carson, 1962; Harding, 1968; Meadows, 1972; Meadows et al., 1992). The concept of sustainable development is perhaps the most recognised term for addressing the need of an interdisciplinary approach and the use of systems science. Among other things discovered early on in System dynamics is the fact that systems are hierarchal so they require understanding how boundaries are created and sustained (Forrester, 1968; Simon, 1969). Simon (1969) understood that in hierarchal systems, communication between each system level is not through the same information variables but from the emerging behaviour within each level, which is transferred between levels. Dörner (1996) called this feedback behaviour 'super signals'. Feedback behaviour was another important discovery as it governs the scale of a system, both temporally and physically. Furthermore, large networks as a part of complex feedback structures and hierarchies have become important for understanding meta system structures (Barabasi, 2003).

Considerable discussion has gone into analysing the nature of feedbacks, their principles and behaviours, and what can be learned from them (Forrester, 1961; Rosnay, 1979; Senge, 1990; 1994; Dörner, 1996; Odum, 1996; Vennix, 1996; Ford A., 1999a; Ford D N, 1999b; Maani and Cavana, 2000; Sterman, 2000; Burns, 2001; Homer and Oliva, 2001; Sterman, 2002; Sverdrup and Stjernquist, 2002; Cavana and Mares, 2004; Warren, 2004). Understanding how to identify feedback loops is one of the vital skills needed to master to evaluate and use System dynamics.

*“Initially the system dynamic practice was performed with differential equations. Dynamo was the first tool that could connect the currently defined SFD concept with differential equations and ‘hide’ that part from the user. Today there are several software packages, called SD-tools (System Dynamic tools) that use a graphical interface in the form of System Dynamic Tool Diagrams (SDTD) to simulate complex models.”
Haraldsson (2005, p5)*

Understanding system boundaries requires contextualising a system in its surroundings and determining its networking characteristics (Forrester, 1961; Ford, 1999b). System characteristics are determined by their complex feedback loop structure. Some feedback loop structures are so common that they possess archetypical behavioural properties. Senge (1990; 1994) identifies 11 archetypical behaviours for certain types of situations in different systems.

Archetypes are important since they tell the history of the system, how it formed (i.e., the interaction between its elements), and how it is likely to develop. Archetypes are useful when analysing complex system structures as an emerging pattern in a system can be compared to its archetype. This comparison enables a clear structuring and sorting of the system variables. On the other hand, an untrained system scientist who uses archetypes risks forcing archetypical behaviours on the system where no such behaviours exist (Lane, 1998). Although systems have generic structures, these structures may be different depending on where in the system hierarchy the observation is made.

Communicating the understanding of a system can only be done if people speak the same language – i.e., use the same terminology and expressions to describe the system. Early research on system dynamics found that communicating the results was as important as generating the results. Although there was a system in place to communicate differential equations in the form of ‘box and arrow’ diagrams (Walker et al., 1923) and ‘stock and flow’ diagrams (SFD) (Forrester, 1961), it was not an efficient way to display complex model structures. Therefore, Forrester (1968) developed the causal loop diagram (CLD) concept as a part of communicating the complex SFD system into a simplified feedback structure. The CLD was initially regarded as a posterior tool for describing ‘ready-made’ simulations, but it was soon discovered that a CLD could be used to conceptualise a hypothesis for a problem (Randers, 1980).

1.3.3 The development of System Science

System dynamics assumes behaviours change iteratively during the modelling process (Lane, 2000; Homer and Oliva, 2001). For some, conceptual models such as a CLD are more important than the simulation in itself. Complex problems are ‘messy problems’ that are too hard to conceptualise, especially if the problem relates to organisations (Checkland, 1981; 2000). Practitioners of System dynamics have debated preferred methods of displaying conceptual models. In the 1970s, CLDs were favoured as they provide a good overview of the problem modelled (Richardson and Pugh, 1981). However, System dynamics tools made it easier to visualise the SFD (see section 3.1) and simultaneously run a simulation. Simulation ‘games’ were developed to enhance the decision-making process for complex problems by familiarising the stakeholders with the issue and providing possible policies that could alter behaviours (Rouwette, 2004). The discrepancy between the CLDs and SFDs prompted some criticism (Richardson, 1986). CLDs were good at displaying the feedback structure but could not capture the specific properties or differentiate between information and quantity feedbacks (Richardson, 1997; Coyle, 2000; Sterman, 2000). SFD models were more accurate than the CLD models and therefore more accurately reproduced the fundamental behaviours in a problem. On the other hand, the SFD models could produce superficial behaviours since they depict processes as flows rather than when the correct feedback structure is incorrectly documented (Wolstenholme, 1999). The current notion is that both approaches are valid for developing a hypothesis, but the researcher should use the approach that best fits the project and client (Homer and Oliva, 2001). In their work on organisation learning, Argyris and Schön (1978) found that people use mental models when formulating, implementing, and reviewing a strategy. Mental models are conceptual maps residing in the mind that depict how one perceives the world. People use mental models to simplify the world and continuously learn and analyse different situations for making decisions. Most people are unaware of this process.

Argyris and Schön further asserted that most people are unaware of the mental model and strategies they were adapting and using. Therefore, a system was needed to consciously manage this subconscious process. In System dynamics, dealing with qualitative feedback loops (i.e., connections of soft, unquantifiable variables) can lead to superficial interpretation of data and uncertainty. Therefore, System analysis that relies only on a qualitative approach to develop a solution has not been very popular within research because of the difficulty embedded with performing mathematical validation in simulations of conceptual feedback loops (Luna-Reyes and Andersen, 2003).

Checkland developed the Soft Systems Methodology (SSM) in which conceptual maps (rich picture) are used to map a Human Activity System (HAS). According to Checkland, SSM is never completed, but can be managed. The SSM focuses on managing the mental modelling process, not describing the real world, by constructing a mosaic of activities rather than a sequence of

activities (Checkland, 2000). Managing a mental model requires understanding emergence, hierarchy, communication, and control within a system. The HAS generates a process that uses specific language that recognises multiple perceptions and lack of clarity within a situation as well as generates a fundamental understanding of what a system is and what it must do (Wilson, 2001). As discussed by Rodriguez-Ulloa and Paucar-Caceres (2004), some elements of the conceptual phase in the System dynamics supports the SSM as they are directly transferable although referred to using different terminology.

From the beginning, it has been clear that System dynamics researchers rarely use models if the models cannot communicate the understanding to the user or the client. Initially, the modelling process suffered from the inability to communicate the results to people with limited knowledge of System dynamics, an issue Forrester addressed with the development of the CLD concept. It was later realised that the conceptual phase of the modelling process was important when dealing with problems collaboratively (Randers, 1980; Richardson and Pugh, 1981; Roberts et al., 1983). Interestingly, System dynamics management research developed a stakeholder analysis approach. Special focus on stakeholder participation can be regarded as an essential phase when designing the conceptual models for the modelling process and carrying out the subsequent scenario planning (Cavana, 1999; Maani and Cavana, 2000; Elias, 2001). According to Freeman (1984), stakeholders consist of groups or individuals who can influence or are influenced by the problem in focus. Stakeholders can be considered dynamic since their behaviours inevitably change – some behaviours might leave the system and some might enter the system.

Depending on their position towards the problem, stakeholders can be defined in three ways: urgent stakeholders – i.e., stakeholders who require immediate attention of their problem; legitimates stakeholder – i.e., stakeholders who accept ownership of the problem according to the current norms or definitions of the problem; and power stakeholders – i.e., stakeholders who have the ability to arrange outcomes of the problem (Mitchell et al., 1997). The position of each stakeholder determines the outcome of the stakeholder analysis and subsequently how the process will develop towards scenario planning. Elias (2001; Elias et al., 2004) integrates a stakeholder analysis by incorporating the basic phases of the System dynamics modelling process suggested as by Maani and Cavana (2000). This process of identifying stakeholders, their interests, and their dynamic behaviours over time and of involving the systems approach in the process has been successfully implemented in several case studies (Cavana, 1999; Elias et al., 2002; Cavana, 2004; Elias et al., 2004). Furthermore, qualitative modelling alone as well as qualitative modelling in combination with quantitative modelling with stakeholders is equally successful in the modelling process and scenario planning (Elias et al., 2004). Interestingly, stakeholder analysis also considers stakeholders who exist beyond the borders of the problem. These stakeholders are not part of the issue but risk becoming so due to the dynamic behaviour of the problem.

Group model building can guide the modelling process by merging the conceptual part of the modelling (the qualitative process) and the quantitative simulation with System dynamic tools (SD-tools) (Vennix et al., 1992; Richardson and Andersen, 1995; Vennix, 1996; Vennix et al., 1996; Andersen and Richardson, 1997; Vennix, 1999). This merging can be seen as an attempt to fuse elements used in the SSM into the System dynamics modelling process. System dynamics effectively enhances understanding of system behaviour and discovery of policies that can tackle strategic problems. However, because strategic decision making is not about finding the optimal policy but about fostering commitment to a decision (Vennix et al., 1996), group model building attempts to encourage team learning, commitment, and agreement but not compromise. Moreover, group model building encourages a group to approach a problem by building a System dynamics model to increase problem understanding that will increase the group's ability to formulate a plan for action where all the members feel committed (Vennix, 1996; 1999).

In group model building, creating a System dynamics model is not a goal in itself but rather a support tool for the decision process. Therefore, simulations can be seen as a continuation of a process that has already resolved the issue in the mental modelling phase. Although the implementation and the verification of results through group model building have varied considerably (Rouwette et al., 2002), the process has one important common denominator – the role of facilitators. Facilitators are central in the group model building as they encourage stakeholders to commit to the process and create a shared social reality to enhance the process (Vennix, 1996; Andersen and Richardson, 1997).

According to Lane (2000), group model building has shifted System dynamics research from a hard modelling science to information science and management of stakeholders, domains more aligned with the social sciences. The role of the facilitator is fundamental as group members are influenced by how the facilitator manages the group. The ability of the facilitator to encourage the exchange of ideas determines the success of the project (Vennix, 1996). As discussed by Vennix (1996; 1999), Vennix et al. (1992; 1996), Richardson and Andersen (1995) and Andersen and Richardson (1997), there are two problems associated with managing the group modelling process. First, the participants (stakeholders) can influence one another through power/prestige games or group think pressure or attitudes. Therefore, group members may be engaged in continuous disagreement and face saving tactics, which can only be corrected by the facilitator or the rearrangement of the group (as a last resort). Second, the facilitator is responsible for encouraging group members to rethink the problem by bringing a structure and method to the group process. Vennix (1996) notes that the facilitator's attitudes, behaviours, and skills influence the quality of the deliberations and ultimately the quality of the decisions. Thus, the facilitator needs to ascertain what is the optimum level of conflict as a certain level of conflict or disagreement, when managed effectively, increases the quality of decisions (Wall et al., 1987).

1.4 Introduction to systems and models

1.4.1 System boundaries

What constitutes a system? Basically everything can be categorised and defined as a system. One way to easily describe a system is to review a technical one such as a bicycle. A bicycle can be considered as a system with boundaries and consisting of several levels. Its functions depend on interactions between the cyclist and its parts (e.g., the frame, chain, wheel, and brakes), which exist on different levels. In isolation, the parts can never be identified as a bicycle because the function of the bicycle is not embedded in the individual parts but in the interaction between all its parts. A person who has never seen a bicycle will have a difficult time understanding a bicycle as anything more than a collection of metal parts attached to one another. However, when this person sees the bicycle being ridden, the bicycle's properties and purpose become evident, including how it connects in broader terms to transportation. Observing the bicycle in action reveals clues to its inner workings as the inner parts of the bicycle are hidden from view.

All systems have similar properties. They are connected in a network that functions as a whole but individually connect with their surroundings through a few variables, which are their communication portals with other systems at different system levels. Simon (1969) calls this 'interaction between an inner and outer environment', a phrase later shortened to 'super signals' by Dörner (1996). Super signals are reduced complexity where the number of features that contribute to a specific behaviour are collapsed into one feature. Complexity is therefore understood as super signals that contribute to complex behaviour. The bicycle interacts with the 'outer' environment through its movement, not through the user as the user is part of the bicycle's functional properties. The 'system boundaries' for this functional system include the user and the bicycle.

Any system study starts with defining the boundaries of the problem. System boundaries are important because they instantiate the function of the system. Therefore, system boundaries need to be defined and understood before systemic solutions can be implemented (Wolstenholme, 2004). Defining and understanding the boundaries of complex problems is needed before objectives can be framed, problem behaviours can be identified, and the questions can be addressed (Forrester, 1961; Randers, 1980; Richardson and Pugh, 1981; Roberts et al., 1983; Maani and Cavana, 2000; Haraldsson and Sverdrup, 2003; Haraldsson, 2005). The definition of the problem sets the system boundaries. This requirement does not imply the whole problem is covered within the system boundaries, but it does represent where the goals and objectives for decision strategies are possible. Therefore, the focus on strategies is limited to certain areas within the problem.

This concept of boundaries can be explained by a simple example. Let's say we are observing a situation where we see our neighbour dog being harassed by a stranger. We see an incomplete picture but we are able to witness a man kicking a dog with no pretext for this situation (Figure 1.13).

This action gets our attention (since we are against animal abuse) and we want to investigate further. We have immediate questions: Why is this happening? What is the cause? As soon as we start to investigate, we frame our understanding by defining the boundaries of the system (i.e., what is inside this situation).



Figure 1.13. As we are about to learn, not everything is as it seems. Later, we will look at the resulting causal loop diagram. Illustration by Hilda Haraldsson.

What is inside the system boundaries depends on what we include or exclude. The systems analysis will have different outcomes depending on what is included and excluded. However, we must use several qualifiers and these qualifiers will define what items we include and what items fall outside the boundaries. Therefore, this question of inclusion and exclusion is important because it connects the problem to the symptoms or effect – i.e., the situation being observed. For the man and the dog, we will need to define the context. Is it only the man and the dog? Is it something more, such as the dog's aggressive territorial claim to a nearby garden? If so, what is the man's connection to the garden? Does the dog view the man as an intruder, like a postman? Is this "postman" inside the system boundary? Is the neighbour child playing in the garden significant? See Figure 1.14.

Some may think we have described an unpleasant situation and think we should find better examples. This, however, is an irrelevant objection, since unpleasant situations often represent situations with symptoms of a deeper underlying problem that needs to be analysed to uncover the problem that causes the symptoms. Thus, we should not restrain from analysing a just because the situation is unpleasant. The difference between symptoms and problems is not apparent when observing characteristics of a system (Dörner, 1996). There is a tendency to conflate symptoms and problems when describing system properties. However, complex problems are simply systems that manifest themselves through symptoms. Symptoms are the emerging properties from the problem behaviour.

An emergent output can be compared to the world experienced in, for example, a computer game. This imaginary world does not exist physically;

it emerges from the execution of the simulation code. So, if everything goes wrong in the game, you cannot smash the monitor and rescue the hero inside the machine, because he is not there. Your mental pictures are also emerge from the neurons in your brain. Thinking of a stone does not imply that there is a stone in your head, only the emergent projection of the stone is “in” there. A mental concept may be real, but it lacks physical manifestation. It is very important to understand that systems have real emergent entities without physical manifestations that can affect the real world. As physical events may shape mental thoughts and thoughts affect and initiate physical events, emergent outputs of systems are an important part of understanding systems.

In a sense, symptoms are incomplete images (i.e., clues) of what is going on inside a system. Causal relationships and feedback are not necessarily revealed to the observer and therefore only part of the problem is visible. Only through transparency of all the feedback and causal relations can a problem be considered visible. Complete transparency implies obvious system boundaries around the problem and therefore confinement of the problem. As for the situation with the dog, we can establish through the systems analysis process that the dog was guarding the garden where the child was playing. The person who was involved in the situation was the postman trying to deliver the mail, but the guard dog made this impossible as it bit the man (Figure 1.14).

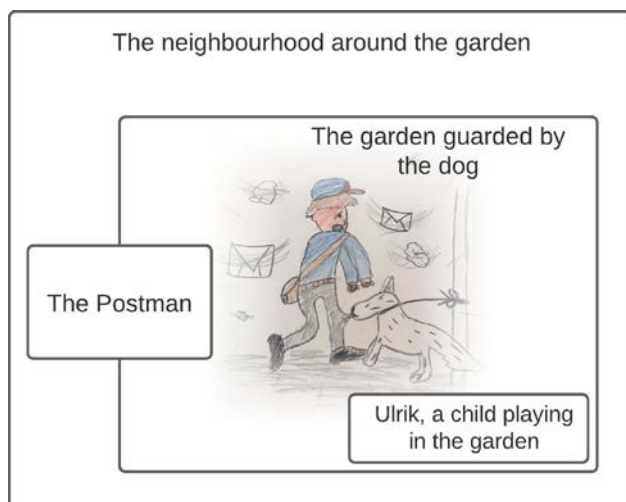

Figure 1.14. The question must be articulated exactly in order to accurately define the system boundaries. This accuracy allows us to sort between what data/information we must include and what we can safely exclude.

This frame of reference in time and space gives us a better understanding of the causality structure of the problem. Now, we can establish a cause and effect structure regarding how the events developed and how the different actors (i.e., the postman and the dog) influenced the events through their actions and reactions. Do we have a reoccurring behaviour – i.e., does the dog always attack the postman? What is driving the dog to attack the post-

man? These are questions that help us understand what feedback loops and driving forces (e.g., something prompting the dog to bite) are creating the behaviour and what measures we can implement to solve the problem. On a general level, a problem has a dimension where all the causal relations and feedback actions are confined. The goal of the modeller is to obtain as much knowledge as possible about the problem to make its system structure visible. Most problems are so complex that we have to be satisfied with partial knowledge of the system. Partial knowledge provides a limited overview of the problem or understanding of only part of the problem (Figure 1.15). Understanding the system structure requires identifying transparent causal relations and feedback structures. Randers (1980) proposes that familiarisation with a problem starts by defining questions such as ‘What caused the given development in the problem?’ and ‘What are the possible effects of the proposed policy?’. This general approach to defining and confining the problem has been followed up by a number of authors (Richardson and Pugh, 1981; Roberts et al., 1983; Maani and Cavana, 2000; Sterman, 2000).

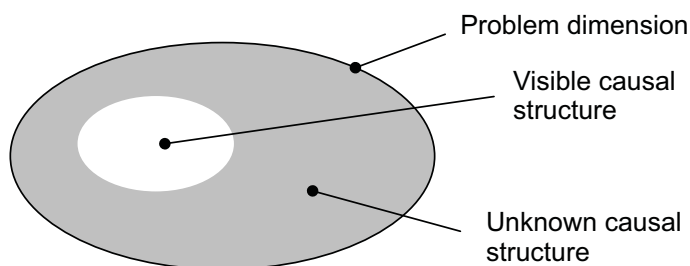

Figure 1.15. The visible causal structure is only part of the problem structure and can initially be manifested through symptoms.

Haraldsson and Sverdrup (2004) argue that the question posed for the problem aims to clarify parts of the system structure. The driving variables that are connected to the question make the system structure visible and reduce the overall obscurity of the system. This is fundamental when constructing the conceptual model. Each question posed is essentially a single model, since the analysis of the question entails clarification of the system variables and their feedback structure in regard to that particular question. By treating each question as a single model, the system boundaries of the problem become more visible and the assumptions and limitations in the modelling process more defined. This has been shown in several cases (Haraldsson et al., 2001; Ólafsdóttir et al., 2001; Haraldsson et al., 2002; Haraldsson and Ólafsdóttir, 2003) as well as in the research programme SUFOR (Sverdrup and Stjernquist, 2002). Wolstenholme (2003) further supports the assertion of using clear system boundaries to frame the problem properly, although the same model slightly modified can be used to answer sub-questions closely linked to the main question.

Depending on the purpose of the study, System analysis may reveal few or several questions that need to be answered. A general overview of a problem

may require answering only a few questions, whereas a detailed study that requires precise answers can include many questions (Figure 1.16). An example of a detailed study is the SUFOR¹ programme. SUFOR provided scientific guidelines to ensure the long-term economic profitability of the Swedish forestry industry without compromising long-term biodiversity of Swedish forests. A large part of this work was to develop a forest ecosystem model that combined several environmental and anthropogenic factors (e.g., biogeochemistry, forest management, climate change, and pollution). The ForSAFE model was developed as a result of the SUFOR programme (Wallman, 2004). The ForSAFE model integrates three models: Decomp (Walse et al., 1998); PnET (Aber and Federer, 1992); and SAFE (Alveteg, 1998; Sverdrup et al., 1998). These models formed a meta-model to answer questions that the individual models could not answer on their own.

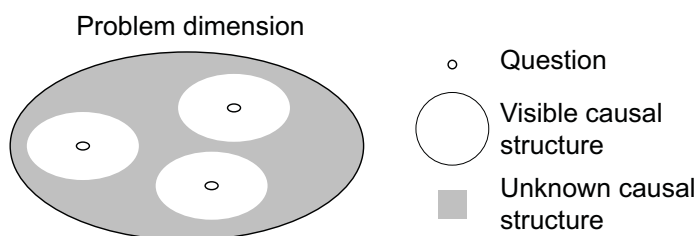

Figure 1.16. Each question aims at addressing part of the problem's dimension to clarify the underlying feedback structures.

Each of the smaller models address a question that resides within the same problem dimension – i.e., forestry and biodiversity (Figure 1.17). SAFE targeted the biogeochemistry cycle, PnET targeted forest growth, and Decomp targeted decomposition of forest material. When combining the models into ForSAFE, each model was modified to fit in the new model hierarchy. ForSAFE required less input data than the individual models combined but performed far better than the models performed individually. The integration of the models made the feedback structure between the different models visible, reducing some of the uncertainty and assumptions required by the individual models.

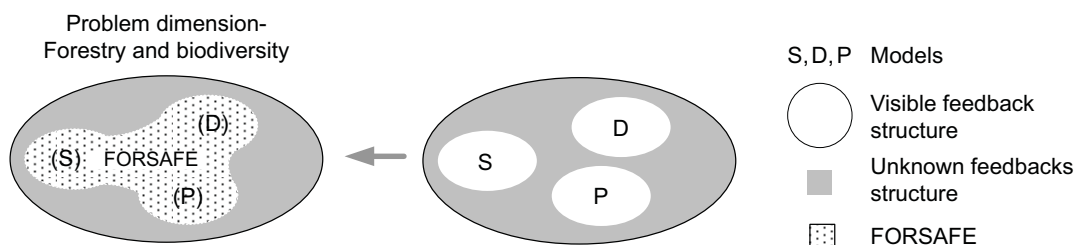

Figure 1.17. Three models – SAFE (S), Decomp (D), and PnET (P) – were combined into an integrated model, FORSAFE.

¹ Sustainable Forestry in Southern Sweden. The programme ran eight years (1997–2000 and 2001–2004) and was funded with 106 million SEK from by the MISTRA Research Foundation, Stockholm, Sweden.

Once the basic principles of ForSAFE were in place, it became easy to add modules to the main structure. Addressing the question on biodiversity, which was one of the primary goals of the SUFOR programme, was now possible and the current developments of ForSAFE address biodiversity in forest ecosystems in general. ForSAFE demonstrates a useful modelling practice where the principle feedback structures are visible, where inputs are defined and determined, and where outputs can be observed and tested.

1.4.2 Model use and components

This report uses the following definition of the concept model: model utilisation is defined as a theoretical model and a numerical model (Figure 1.18). A theoretical model is the knowledge and understanding used to explain and predict behaviour. A theoretical model identifies the problems, questions, and feedback structures and develops strategies for addressing the problem. A theoretical model represents the core principles for the numerical model. A numerical model is the domain of mathematical equations and structures used to explain the same behaviours captured in the theoretical model. A numerical model is the core calculator and may include code used to simulate mathematical equations and relationships to produce output.

The combined use of theoretical and numerical model is referred to as model utilisation (Haraldsson and Sverdrup, 2004; Haraldsson, 2005). Model utilisation is the total required functions needed to produce results from the whole modelling procedure, including support modules – i.e., relevant information, data, and methods (see ‘Input data preparation’ in Figure 1.18) – and transforming these according to core principles, interpreting outputs, and identifying limitations. Information (symptoms and problems), knowledge, and purpose determine the understanding of the limitations and how the results are interpreted. The purpose of the modelling task may be adjusted according to the results interpreted from the simulation or according to new understanding developed in the theoretical model according to the learning loop, which is more fully discussed later.

An example of model utilisation is the use of the model PROFILE (Sverdrup and Warfvinge, 1993; Haraldsson and Sverdrup, 2004; Haraldsson, 2005). The PROFILE model is a type III model used to determine the mineral weathering rate in soil. The use of the PROFILE computer code in the SUFOR programme was only a part of a complete PROFILE model utilisation. For example, PROFILE was used to determine the weathering rate in the forest ecosystem at Asa Research Park in Sweden (Holmquist, 2001). In this case, PROFILE was a part of a model utilisation where the collection of data and its processing and preparation along with the interpretation of the output set the limitation for the usability of PROFILE. The model utilisation for PROFILE also included the user who conducted the study as he was part of developing the hypothesis and interpreting the results and its limitations. Therefore, the emerging PROFILE model becomes the whole process of utilisation, including the PROFILE computer code, use procedures, and supporting model tools.

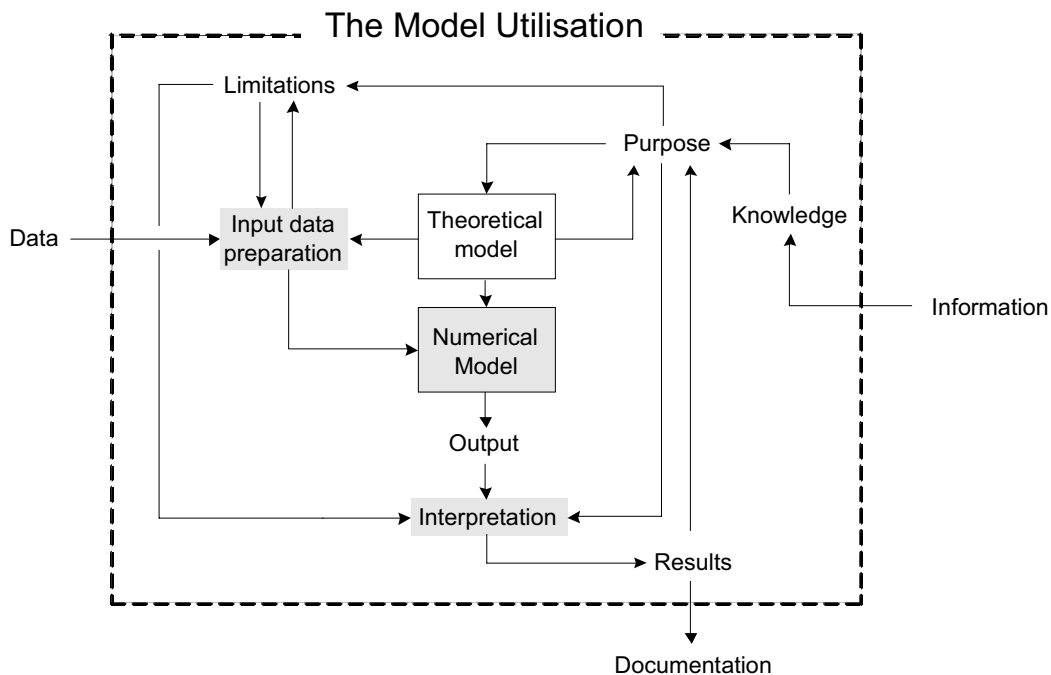

Figure 1.18. Model utilisation is the use of the theoretical and numerical models combined with all the required factors needed to successfully produce results. The questions become a part of the model by defining the purpose. Even the users are part of the model.

Every model starts as a theoretical model. Depending on its purpose, it may include a numerical model evolved from the theoretical model to confirm its structure through simulation. Depending on the purpose, a theoretical model may address questions that only require answers through conceptual mapping. A theoretical model that requires quantitative answers uses a numerical model as a continuation of the theoretical model. Using the numerical model subsequently becomes an iterative process of defining and confirming the theoretical model. When models are shared, they should include an explanation of the entire process of using the model. Sharing only a numerical part of the model keeps the model user in the dark regarding the model assumptions and limitations as well as the preparations required to use the model successfully.

1.4.3 Model properties and performance

The types of models used in research needs clarification. A model is any conceptual understanding of a phenomenon, event, or connection that can be used to evaluate cause and effect. Because the properties of the models vary depending on the research purpose, it is necessary to define what constitutes a model. A model is a simplified representation of a phenomenon observed in the real world and is any consequence or interpretation taken from a set of observations or experiences. Models are first and foremost mental models, a conceptual understanding of a system that in a later phase can be converted into mathematical models. Many problems in natural systems are so complex – i.e., non-linear and multi-dimensional – that they require a non-linear approach to solve them. There is a tendency when making simplifications to

deal with complexity in a linear fashion. Poorly defined causal relations are rather expressed with linear correlations than with non-linear properties. Using a linear approach to handle complexity requires complex explanations of the problem, obscuring the fundamental understanding of the problem.

Linear approaches to complex problems tend to de-emphasise understanding and emphasise the complexity of the model's variables and input data. Models that require complex explanations are hard to communicate as their principles and processes are not transparent. Validating models requires insight and understanding of the processes and how the essential parts of the model are constructed. Models are important not because of the results they produce but because they allow investigation of non-linear systems and data from such systems to be interpreted. Models further allow for investigation into multiple simultaneous processes in a single experiment.

Models serve one or both of the following purposes (Haraldsson and Sverdrup, 2004):

- Testing the synthesised understanding of a system, based on mathematical representation of its subsystems and the proposed coupling of subsystems.
- Predicting what will happen in the future, based on the ability to explain how and why things have worked in the past.

Models must use understanding of historical feedback to simulate and recreate past behaviour. When that behaviour has been successfully tested, it is used to test alternative future scenarios. Levenspiel (1980) classifies all models into three types according to their purpose and their analytical and predictive power: qualitative, quantitative, and differential (Figure 1.19).

Type I	→	Type II	→	Type III
Qualitative description A picture of the moment		Direct quantitative Description in terms of observable conditions		Differential model Rate based on underlying physics and processing conditions

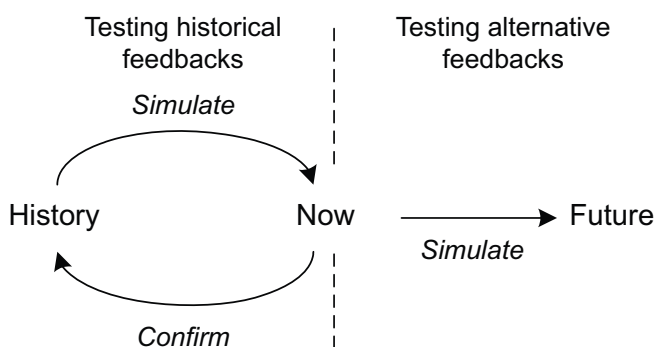

Figure 1.19. Models must successfully recreate the past to successfully predict the future and design future scenarios (new figure available).

Type I models explain a certain occurrence that is predictable based on present conditions. Such models are static and have very limited predictive power. Typical for type I models include maps, e.g. geological maps that depict how rock and minerals geographically distributed.

Type II models are based on case-by-case predictive power. They must be recalibrated using new data when the boundaries and initial conditions change. For example, plotting pH over time in an acidified lake. The type II models are limited to individual cases because their properties cannot be transferred to another case.

Type III models use the differential approach as they track change through time. The approach was first used in physics but later in all the natural sciences. Changes at every point in time are related to the system state at that time. A type III model introduces the mechanism of change through state variables where the state of the system is characterised by conditions in terms of order (e.g., spatial distribution), concentration, and capacity for adaptation. As a type III model is differential, it requires mathematical manipulation. A type III model is generally valid and applicable when parameterised properly and the coefficients are estimated. An example of a type III model is ForSAFE.

The quality of models depends on their principles and the steps that precede their construction. There is a need to differentiate between the goodness of models and the goodness of model performance.

1. The goodness of models

- a. A good model is transparent, where every principle in the model can be inspected and scrutinised. It is important to remember that the model is not the computer model itself, but rather the whole model system into which the computer routine is used. The model is useful when users can easily identify and understand the required inputs, make sense of the outputs, and deem accuracy appropriate.
- b. A bad model hides or conceals parts, so important parts cannot be scrutinised or tested. A bad model can be bad because it uses 'inputs-outputs' that are not defined or impossible to understand. Furthermore, a bad model can have outputs that are not relevant or cannot be interpreted. All these characteristics limit the model's usefulness.

1. The goodness of performance

- a. Good performance implies that a model can be used to answer the question with a high probability of being correct. There is always uncertainty in any model, but transparency can help control uncertainty.
- b. Bad performance implies that the model is not capable of producing an answer or explanation with the required accuracy.

A model may have bad performance that is irrelevant to the goodness of the model. Bad performance can be improved if the model adheres to the principles of a good model. Due to the nature of the model development process, all models will start with poor performance and work continues until satisfactory performance is reached.

1.4.4 Simple vs. complex models

A common mistake is to assume that a successful model needs to be complex and use a lot of input data. However, a model needs only serve its purpose: to answer the question that is being posed. Improving a model that has already answered the question is unnecessary. Therefore, it is always relevant to reflect on the purpose of a model and its application as a simple model can answer a question with enough performance for a strategic decision to be formed. A simple model is easy to use, and the input data can be obtained with relatively little effort even though it must make complex assumptions (Haraldsson and Sverdrup, 2004). However, because of its simplicity, a simple model's applicability may be limited and addressing the effect of the assumptions will be problematic.

On the other hand, a complex model can make simple assumptions, since the variables used are specific and can be more easily quantified. A complex model will have better general applicability but requires more input data, making them more expensive to construct and use.

Increase in model complexity will remove some of the assumptions and focus on more detailed feedback. However, increased complexity places higher demands on the quality of the input data. The total system complexity in modelling is divided between the assumptions and the model itself. As an optimum complexity exists for every question, great care should be taken when evaluating the optimum level of complexity. Failing to do so can result greater uncertainty. Because complexity within a system cannot be disregarded, model designers must decide whether the complexity is part of the model or part of the model assumptions. All models must fulfil the minimum requirements to describe events and their history based on real data. If a model fails in this regard, predicting future events may be met with limited success.

Designing and constructing models is tedious, especially when many questions need to be addressed (e.g., the FORSAFE model). As discussed in Haraldsson and Sverdrup (2004), a problem that includes many questions may require equally many models. The objective is to design a model that is robust, simple, and the right size (i.e., the fewest components that will increase performance) (Figure 1.20). Sufficient performance, not perfect performance, is the goal. Such models can save both time and money and provide useful building blocks for further model developments.

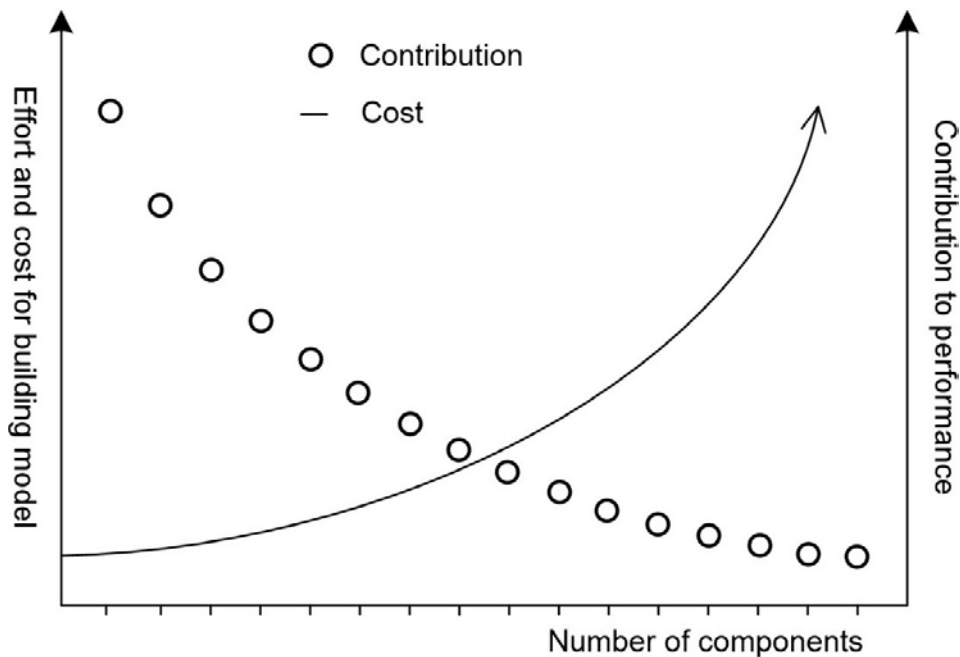

Figure 1.19. Adding further components to the model will increase the efforts and the costs of designing and constructing the model, while the marginal calibration of added components might decrease.

1.4.5 Performance vs. complexity in model components

Any modelling task must start by sorting the causalities and the feedback mechanisms in the problem around a question. A model will contain a certain number of key components that describe the main causalities. Causalities that have an observable connection to the problem will contribute to performance to a greater degree than causalities that have a less observable connection to the problem. The system boundaries are drawn around the number of components with the sufficient number of causalities to answer the question. Adding an extra cause to the model may contribute to the overall performance of the model, although it will also add some causality that may not necessarily be symmetrical to the main model causalities (Figure 1.21). A model can only approximate a problem as each component brings uncertainties into the structure. Adding further causalities to a model will increase the necessary details that the model will incorporate, but this will also increase uncertainty.

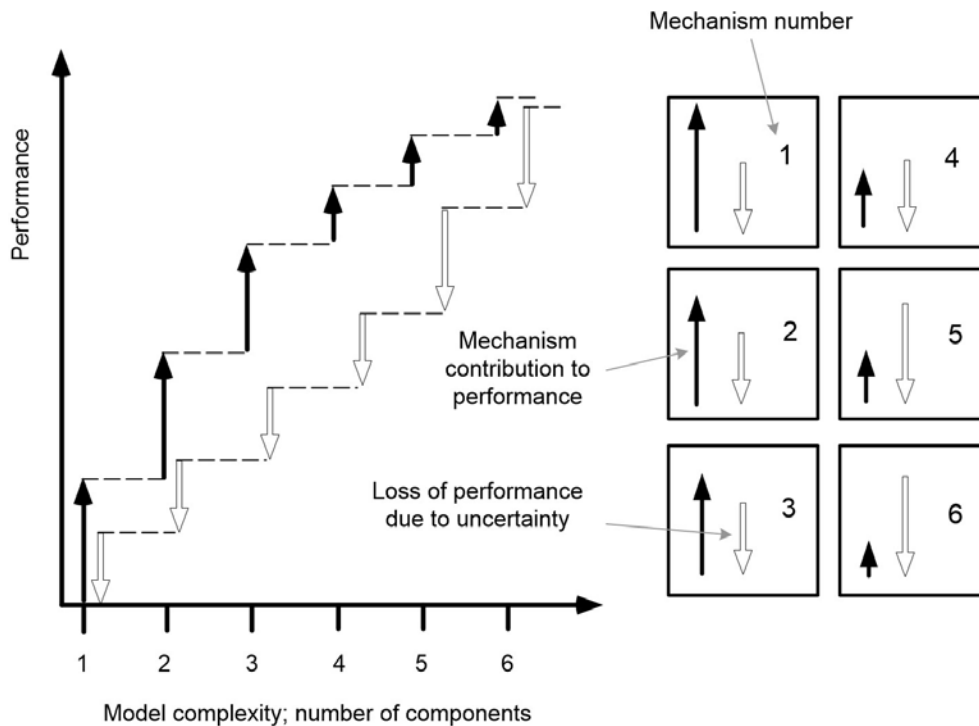

Figure 1.20. Adding a cause contributes to the overall performance as well as uncertainty of the model, but its contribution is not necessarily symmetrical with other causalities in the model.

Causalities always involve some uncertainty, and increased uncertainty will lower the overall performance of the model. Performance of a model will increase until the uncertainty in the added cause is larger than its contribution to performance. When uncertainty in the added cause is larger than its contribution to performance, the overall performance of the model will actually decrease (Figure 1.22). The point of no improvement is characterised as the point where extra input will result in more inaccuracies than the extra complexity is able to improve performance. Thus, a model with more complexity than is required to answer a question will not necessarily result in a better answer. In Figure 1.22, the highest model performance is achieved with three causalities, but further addition involves higher uncertainty than better contribution to performance. All models experience this type of peak performance in relation to number of causes. Depending on the model's characteristics, the optimum point of performance can range from a few components to hundreds of components.

Several assertions can be made about questions and complexity (Haraldsson and Sverdrup, 2004). A question derived from a generalised definition of a problem requires complex assumptions about the processes. The variables incorporate a whole range of assumptions about the underlying processes they are intended to describe (e.g., social behaviour in conflicts). A question derived from a definition of a highly specified problem requires more knowledge about the function of the variables, so the action between each variable is often determined empirically (e.g., rates and fluxes). The assumption is then

placed on the empirical certainty in the variables that are statistically verified. Thus, the actions between the variables are also perceived as empirically certain due to the knowledge about the variables.

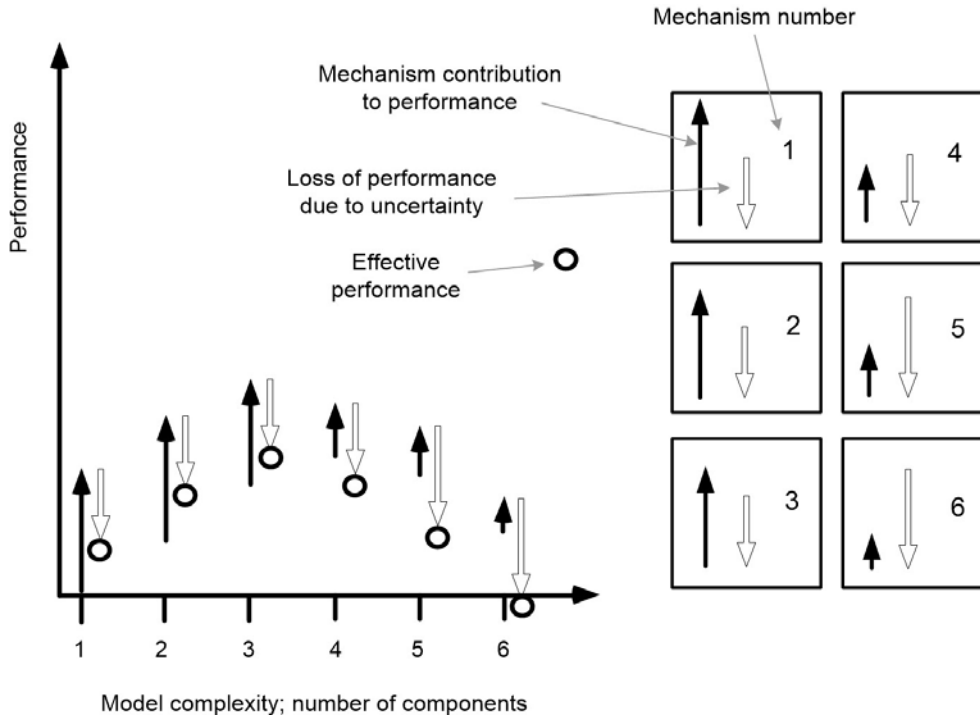

Figure 1.21. Adding a cause involves uncertainty, which can eventually overshoot the contribution of the cause to the performance of the model.

1.4.6 System levels and scales

Understanding system levels helps determine the level of details necessary to answer the question derived from the problem. A problem can manifest itself on many levels (system levels), so understanding the problem requires analysing which level the symptoms reside (Simon, 1969; Powers, 1973; Dörner, 1996). A system manifests in scales and levels, both temporally and physically (Figure 1.22). The temporal scale can range from seconds to minutes or years to infinity (depending on the system). The time frame of systems is set according to the delays of its feedback. If the system has a feedback mechanism that takes 100 years to complete, then this will determine the time frame of the system. Depending on the focus of the question, feedback with very long delays can be disregarded if the focus is on a very narrow time frame (e.g., geological cycles that take million years in relation to the human society). A system manifests as well in a physical scale and the physical scale is the size of the system in a spatial perspective. A system can interact on different levels but be confined within a narrow physical scale. For example, the human body has many system levels – cells interact on a micro scale with each other to form organs and the organs interact with each other on a macro level to form the body. Although the human body is an extremely complex system with interactions on multiple scales, the body only occupies an average of

0.075 m³ space. On a physical scale, the human body as a system is small and resides on a macro level compared to, for example, climate. The climate system has, like the human body, many system levels, but occupies a much larger physical space. Although the two systems are different, they can interact. Climate can influence the human bodies and vice versa, but climate resides higher in the system level hierarchy. Similar to the temporal scale, feedback loops interact with multiple levels of a physical system. In the human body, the cells are systems themselves that interact with other cells and organs. This interaction creates delays between the organs and the cells. For example, a person who starts running does not feel the effects of running until the cells require more oxygen.

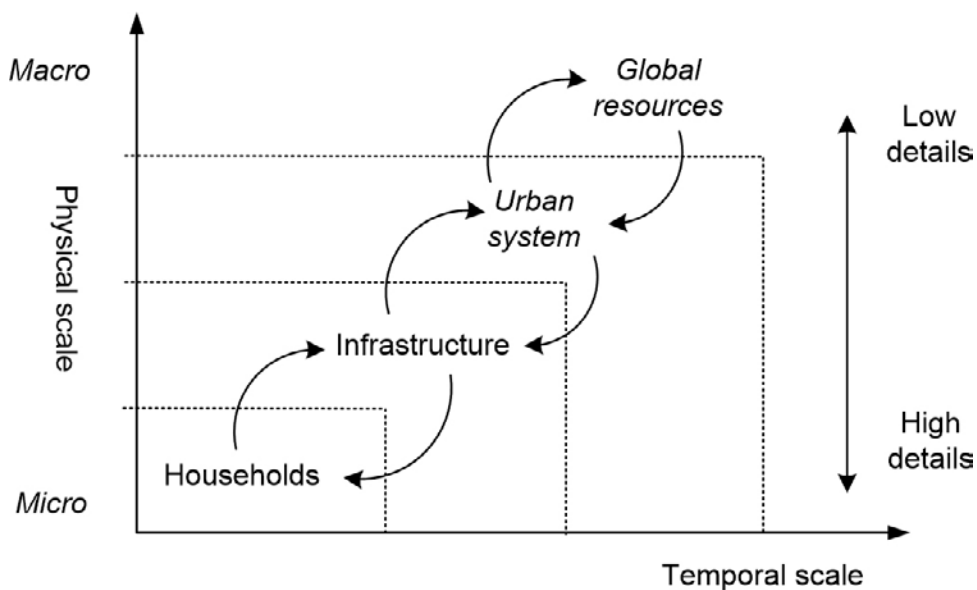

Figure 1.22. Models have their place in physical and temporal scales. In this case, the question for the problem has created a system boundary that is drawn over four different physical and temporal scales.

In the climate system, humans emit CO₂ that affect key variables in the climate system, changes that ultimately affect the climate. That is, the feedback effects result in a rise in the global temperature. However, the physical size of the system creates long delays in the feedback effect. The feedback mechanism between the micro and macro level on the physical scale are closely related to the temporal scale. The larger the physical and the temporal scales, the longer the feedback delays. Models are built on variables that embody behaviour from causal relations found in sub-systems. The emerging properties, in Dörner's language super signals (1996), from each system level are what drive the level above them or below them. Therefore, it is crucial to identify where in the physical scale and temporal scale the model is operating. The greater the number of components in the model, the more interactions there will be between the system levels (Dörner, 1996).

A model can have components that occupy different levels simultaneously; however, depending on a model's focus, these components occupy specific levels in the system hierarchy. Some models work on the micro level (i.e., high details but low in the physical scale), and some models work on a macro level (i.e., low details but high in the physical scale). Most complex models possess combinations of both properties (Figure 1.23).

A model should include only the variables needed to understand the problem and that need to be influenced. After defining the level, detailed knowledge of the underlying components is not necessarily needed. This knowledge may fall into the complex assumption made during the sorting process. Sterman (2000) defines this as a structural assessment test. Driving a car, for example, does not require understanding how an internal combustion engine or an electrical motor works – i.e., a car can be operated without such knowledge. When defining and confining a problem, it is helpful to place systems and concepts on a scale diagram such as in Figure 1.22 or Figure 1.23. This strategy makes it possible to draw causalities between the systems through different system levels and observe the different physical and temporal scales of the feedback loops between the systems. Complex models such as FORSAFE use other models as sub-models in its model structure. These models have variables working on a macro level as well as micro level (Figure 1.23). The question for the problem determines what systems are analysed and what causalities are considered. The system boundary is set around the question and the systems that are involved.

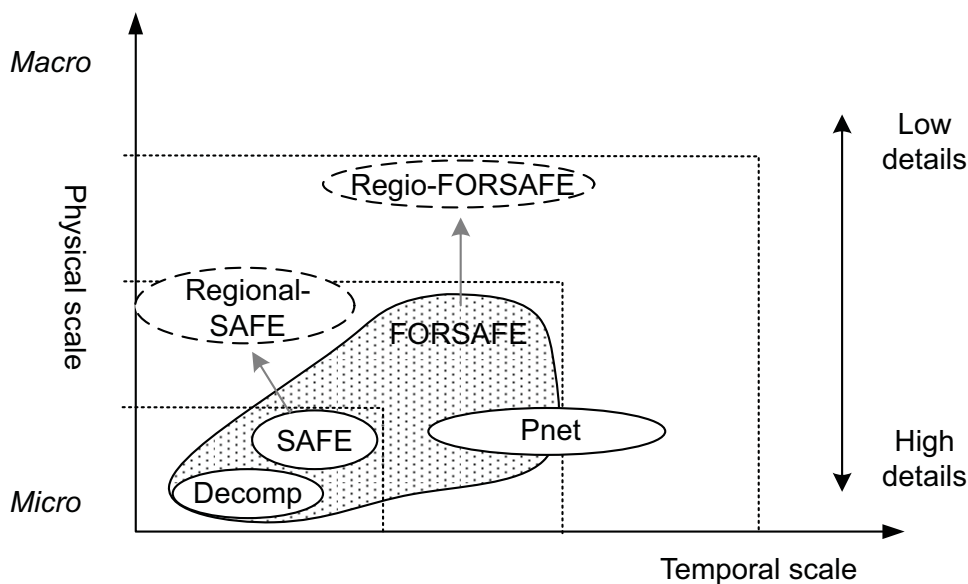

Figure 1.23. ForSAFE uses Decomp, SAFE, and PnET as sub-models in its model structure.

For FORSAFE (Figure 1.23), the system boundaries are spread over different system levels as well as different temporal scales. Not all models were fully incorporated into FORSAFE (e.g., the Pnet model), but the parts that were useful for developing FORSAFE were included. Region-FORSAFE, a model

used for regional applications, originated from FORSAFE model, and Regional-SAFE, also a model used for regional applications, originated from the SAFE model (Martinson, 2004).

1.4.7 Understanding delays

Delays are also discussed in the literature (Ford, 1999a; Maani and Cavana, 2000; Sterman, 2000). All systems have some kind of temporal delay, ranging from seconds to days and centuries to millennia. Delays cause systems to fluctuate as delays occur when actions between two components in a system are slower than the rest of the system. A system consists of many feedback loops that reinforce certain behaviours (i.e., a positive feedback loop, indicated with R) and other feedback loops dampen certain behaviour (i.e., a negative feedback loop, indicated with B). Oscillations are generated by the interaction between positive and negative feedback loops when the causality is delayed in one or more time steps. The non-linear relationship between the variables in combination with feedback loops create non-linear behaviours, and these behaviours require numerical models to be understood. Due to the non-linear behaviour of the system, feedback loops can shift dominance during an observation period (Ford 1999b). Therefore, delays are conceptually hard to predict since they are not always manifested at the time of the observed behaviour. By learning the history of the system and observing the scaling of the variables (i.e., where in the system level hierarchy and temporal scale they are placed), it is possible to gain a better understanding of the pace of the action between the variables. A system that crosses different system levels and includes a long time frame will inevitably produce delays.

Typically, the longer the delay, the larger the oscillation. This relationship may pose some difficulties when analysing a problem as feedback loops with long delays risk being obscured during the process and therefore risk being missed. Therefore, the steps that precede any analysis of a system should attempt to understand the properties of the problem and how the symptoms are manifested. Delays in a system are created in three ways:

1. Buffering mechanisms such as stocks (fluxes) that take time to be filled or emptied.
2. Kinetic limitations where a process may proceed at a limited rate of reaction progress or rate limitation in a transformation process. This is also called a bottleneck when transport systems are considered.
3. Transmission delays where there may be low velocity transitions within the system, e.g., transoceanic transport.

Even if we nominally have conditions that would allow for equilibrium, these conditions may not be instantaneous, resulting in delays and therefore oscillations (Prigogine, 1980).

If several delays are present in dependent systems with feedback loops, the oscillations may become very complex and despite underlying systems of order the output behaviour of an integrated system may appear chaotic

(Prigogine and Stengers, 1985; Wolfram, 2002). Buffering delays, kinetic delays, and transmission delays are common in earth systems (Ammerman and Cavalli-Sforza, 1972; den Elzen, 1994; White and Brantley, 1995; Lasaga, 1997). If several delays are present in a dependent system, its oscillations may become very complex and despite underlying order the output behaviour the system may appear chaotic (Prigogine and Stengers, 1985; Wolfram, 2002). In earth systems, this chaotic behaviour is the result of all three types of delays: buffering delays, kinetic delays, and transmission delays (Ammerman and Cavalli-Sforza, 1972; den Elzen, 1994; White and Brantley, 1995; Lasaga, 1997).

2 Systems Analysis

2.1 Introduction

As you probably have noticed, feedback loops are a significant part of the examples provided. In this chapter, we will look closer at how exactly feedback is formed in a system and linked in a causal loop diagram (CLD). CLD, as a concept, was first discussed in the 1960s (Jay Forrester, 1961) and further developed in the 1970s through the 2000s (e.g., Rosnay, 1979; Richardson and Pugh, 1981; Senge, 1990; and Sterman, 2000). A CLD maps the structure and the feedback loops of a system to develop an understanding of how feedback loops work. That is, CLDs are used to understand how behaviour manifests in a system, and this knowledge can be used to develop strategies to work with or counteract behaviours. In addition, CLDs can provide information about the extent of the problem and how the problem is connected to other systems.

Every time we observe an issue or problem, we ask questions. Every time we want to understand a process, we ask questions – e.g., Why this or that is happening? and How can the problem be solved or understood? CLDs always reflect the implicit and explicit questions being asked. Therefore, we can confine the system to the question asked, so the question becomes the system boundary around the problem.)

2.2 Drawing a causal loop diagram

CLDs describe the reality of causalities between variables and how they form a dynamic circular influence. We want to observe the world through feedback loops rather than linearly, so we can observe patterns that can be used to predict behaviour.

This approach is about understanding cause and effect. Let's look at a very familiar event – filling a glass of water. From a linear point of view, this process starts with the explicit or implicit desire to fill a glass with water, which of course sounds very logical but tells us only half the story. We may control the rate of water flowing into the glass (as the statement implies), but the level of water in the glass also signals when to turn the faucet off. Traditional logic would look something like the following.

In CLD language, we use feedback loops to explain the system processes. We start by framing the problem: I want to understand how water flows into the glass and what I do to fill it up. Rather than looking at the action from an individual point of view, where the “I” is the doer and at the centre of focus, we shift our perception to the structure of the action. The “I” simply becomes a part of the feedback process, not standing apart from it. Suddenly, we have shifted our attention to the structure of the behaviour, so we can now observe that the structure causes the behaviour. A CLD allows us to follow the action

in detail, so we can read the feedback in the CLD as if it were a story. Since we desire a certain water level in the glass, let's start by turning the water tap (the following is modified from Senge, 1990).

We want our water level in the glass to be high; we will call this the intended water level. We turn on the water tap so the water starts to flow. As the water level rises, the perceived gap from the current water level and the intended water level changes. As a result of this changing gap (which reduces the difference), we modulate the water flow by manipulating the tap.

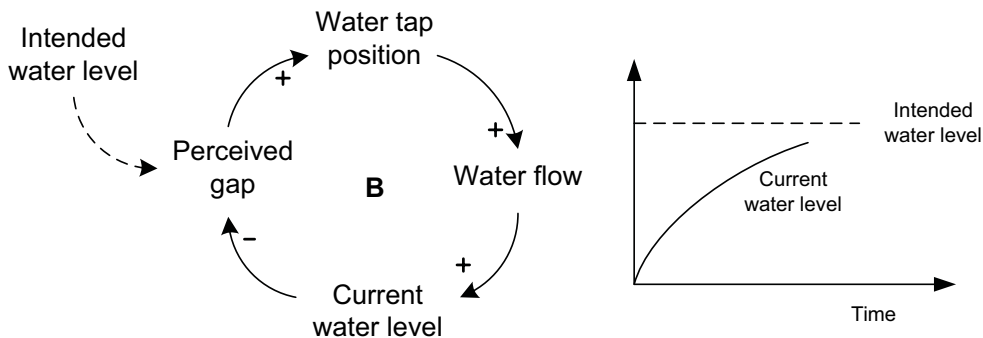

Figure 2.1. The water tap example illustrated.

We have now transformed the traditional linear thinking into a circular argument. Let's at last observe the difference in the perception between the original condition or state – an explicit or implicit desire to fill a glass with water – and the new state revealed by the CLD: The action of filling the glass of water created a system that caused the water to flow into the glass at a low water level to the intended water level.

Both states or variables – the filling of a glass that contains not water and the termination of the filling glass at the intended level – describes the same process but in a different ways. The effects of the last variable (the full glass) influence the input of the first variable (the empty glass), a condition that self-regulates the system, marked “B” for balancing in the middle of the loop. Systems are always organised with feedback loops. Regulation of a system can either result in a self-reinforcing system or a self-balancing system. A self-reinforcing system (or amplifying system) is characterised by growth such as found when computing compound interest or calculating the spread of bacteria colonies. Similarly, the current water level exponentially comes closer to the intended level over time, so the levels are plotted on a time axis in our example.

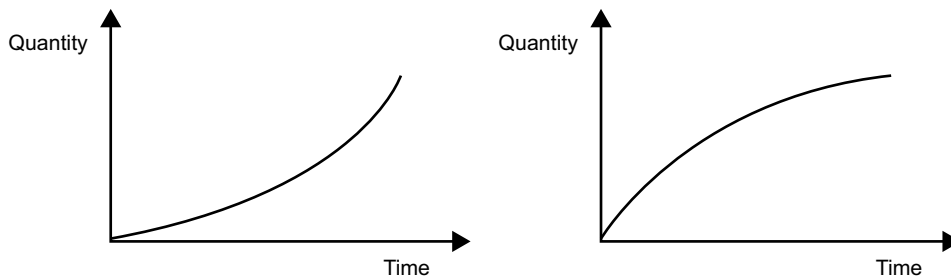

Figure 2.2. The outcome of a reinforcing loop and a balancing loop

CLDs are always drawn on a temporal scale, expressed graphically as Reference Behaviour Patterns (RBP). A reinforcing system is an escalating effect due to equivalent influences between the components, which can be either downward or upward (Figure 2.2). CLDs can also display systems that seek a specific goal, such as the intended water level. A balancing system has a variable that hampers exponential growth or limits the growth of the loop. Filling the glass of water is an illustration of a balancing system seeking a specific goal since the glass can only hold a certain amount of water. This system moves towards stabilisation or a balanced state (see below). To put system thinking into practise, several rules have to be followed so that cause and effect can be correctly illustrated (Figure 2.3), where the causal loop concept is explained (adopted from Roberts et al. 1983, p56). To further illustrate Roberts et al.'s explanation of the causal loop concept, let's look more closely at the variables at work in the loops. Consider a reinforcing system of population that has a high birth rate and therefore a net increase in population. We can use six steps to work out our CLD (Figure 2.4). When determining causalities between variables, we always look at the links separately.

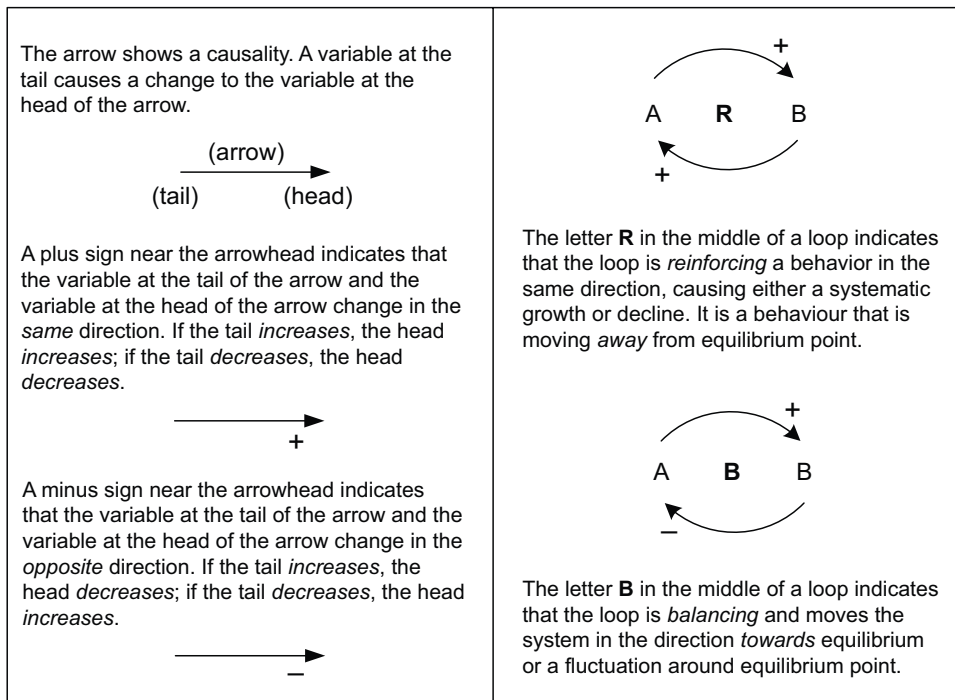

Figure 2.3. Explaining the use of arrows.

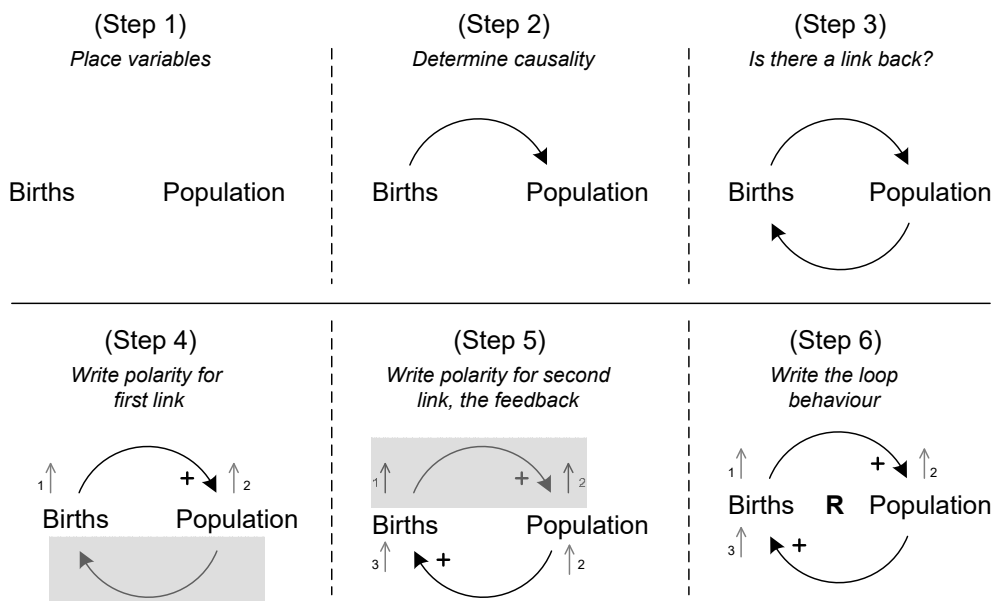

Figure 2.4. Connecting the links.

After putting the polarity (i.e., a plus or a minus sign) on the loop, the small assisting arrows can be erased as they are only there to help determine the loop behaviour. The shadowed feature (Figure 2.4) placed over links indicates that only one link is considered at that time. The feedback from the last variable to the first one (where we started) determines the behaviour of the loop. Increased births came back as an increase in population.

If the variable death is added to the graph, we would work with the loop as in Figure 2.4 before adding the variable (Figure 2.5). In the actual situation, the death rate would balance the increase in population up to the point where number of births equal the number of deaths. The first phase would reinforce the population size and the second phase would restrict the population size. Despite the complexity of systems, reinforcing loops are always temporary states as they will be balanced out by one factor or another. The important issue is to identify how long the reinforcing situation will endure; it can last from minutes to millions of years depending on what we are observing.

Let's look at a slightly more complicated CLD: urbanisation and job opportunities. Specifically, let's look at the situation where people move to cities to find work in established industries. Let's assume that we have decided on this question: What happens to job opportunities when people move to cities? We have sorted out the variables that are part of the system and we start to construct the diagram (Figure 2.6). Now, we need to read the loop's story (Figure 2.6). Industrial job opportunities are created by the establishment of industries in the town (more industry, more job opportunities). This condition drives people to move to town, and when people move to town, they take advantage of these job opportunities, but this results in more competition for the jobs (more people, fewer job opportunities). This is our first loop. The second loop stems from a secondary effect of people moving to town. This influx of people creates demands for services, which in turn creates opportunities for service jobs that serve the industry workers (more demand, more opportunities). Now, when the service job opportunities increase, this state feeds back into the urban migration – i.e., even more people move to the city as more jobs are available. However, these new city inhabitants also take service sector jobs, reducing the number of service job opportunities. Now, we have three loops that affect people moving to town. The variable industry is not affected by any other variable in the loop. That is, industry is an external factor in the system behaviour because it was not part of the original question: What happens to job opportunities when people move to town? Once polarities are placed on the causality links, they never change: You can start with the variable reduced births, which will reduce population, but the polarity stays the same.

Sometimes, reversing a causal loop (e.g., starting with a decrease) can make it difficult to interpret a minus or a plus sign. Let's look at the following example of population dynamics (Figure 2.6). This causal loop suggests that the more people, the more deaths; the more deaths, the fewer people. This sounds very reasonable, but we can also look at these phenomena from the opposite direction: a decrease in the total population. This CLD states that the fewer people, the fewer deaths and the fewer deaths, the more people. But is this necessarily true? If death decreases, does population necessarily increase? No, it does not. For this to be true, the population must be connected to a birth loop: the fewer deaths, the more people remain in the total population. Alternatively, if the number of deaths decrease, the population

still decreases but at a slower rate. The use of the right wording is important when explaining the CLD, recalling that polarity cannot change once it is set and that CLD should read correctly irrespective of direction.

Here is another illustrative example. There is an industry that is causing pollution that is affecting the health of the population. We want to analyse this problem in an historical perspective by looking at past actions taken to solve this problem. Let's assume this is our question: What triggered the response to industrial pollution? After defining the variables, we draw the system and assign the polarities (Figure 2.8). After we have assigned the pluses and minuses (i.e., the polarities), we go through the whole loop and compare the starting and the ending arrows for the initial variable in the loop, pollution.

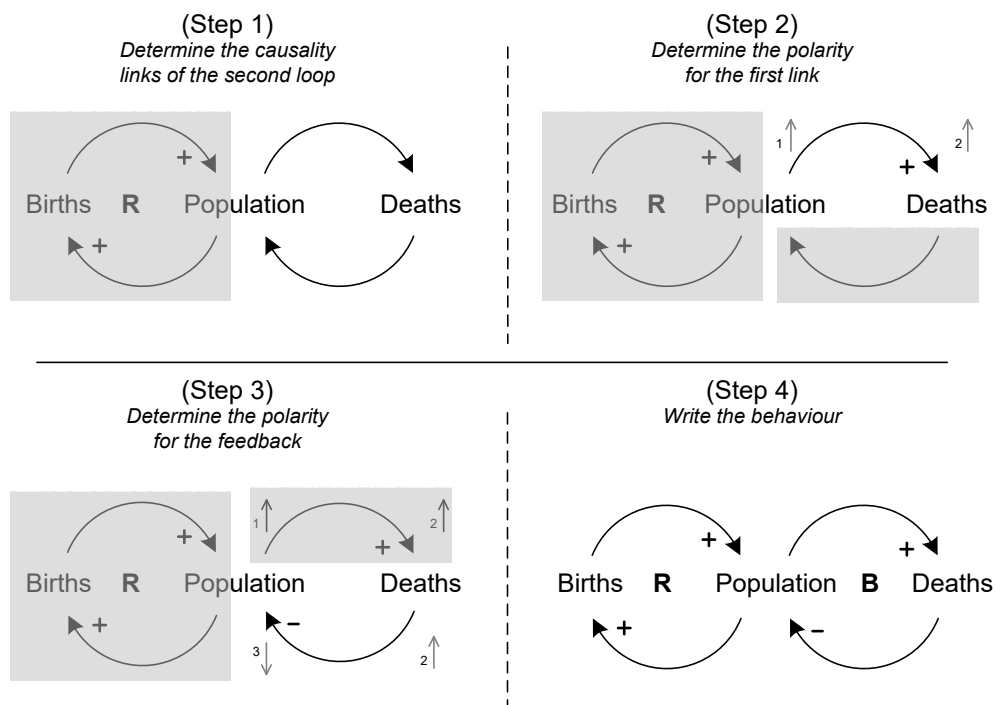

Figure 2.5. Adding a second loop.

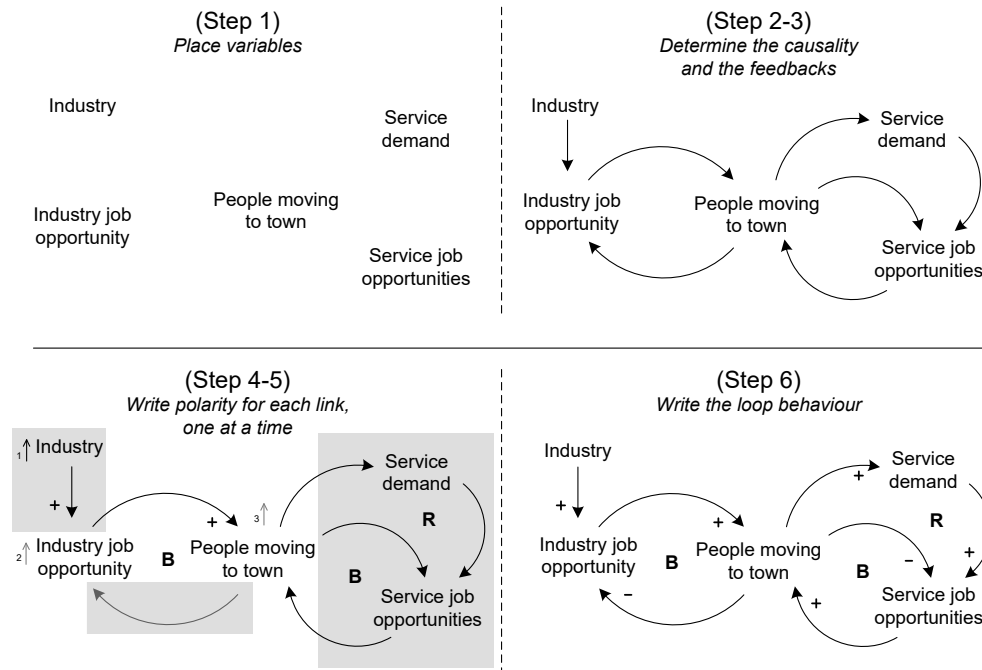

Figure 2.6. Job opportunities and people moving to town.

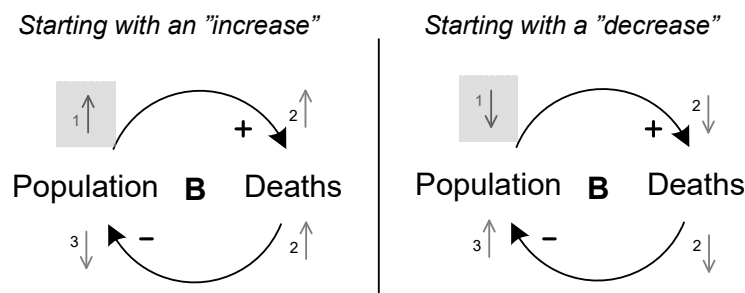

Figure 2.7. How to read, starting with a decrease.

The loop is a balancing system, indicated with "B", since the last variable, measures, influences the variable pollution (I) in the opposite direction. (If the system had starting and ending arrows in the same directions, we would have a reinforcing system, indicated with "R"). From this simple example, we explained how the solution only focused on the pollution itself but not the industry. Industry only has one way to influence the loop, because we have not defined anything that affects the industry. Of course, we could have a link between the variables measures and industry, but this would be another question to be added later.

2.3 Reference behaviour pattern (RBP) and observed behaviour pattern (OBP)

As discussed earlier, the Reference behaviour pattern (RBP) is a graphical representation of the behaviour over time of one or more variables in the loops analysed. We use RBP to chart our understanding of the system. When drawing causal loop diagrams, we should sketch a diagram from each loop to graphically visualise the behaviour of the variable we want to observe in the loop (cf. the example of filling a glass with water). Observed behaviour pattern (OBP) is used to show historical reference states of the variables at a given period. For example, the pollution CLD above and the development of health can be expressed as an OBP and RBP (Figure 2.9). Because we know historically that health was better before the pollution increased, we can assign it as so on the graph. Of course, we assume the industry is maintaining its pollutant output, so we plot the health decreasing toward some conceptual level. Historically, health worsened, so we can plot the OBP and draw the RBP onto those points. We plot the loop as non-linear since the loop shows a balancing state. The slope of the loop is less important, as it might be just a linear decrease and this takes us into numerical aspects. We could also look at any other variable or put them all together into an OBP and RBP in order to get a better understanding of what is actually happening in the CLD (Figure 2.10).

Although purely conceptual, RBP can indicate how the behaviour of the variables develop when the loop changes. We have the historical information that the variables had the qualitative quantity as explained in the OBP, so we can then draw the behaviour between the dots. In the diagram, we only increased the time axis to see how the immediate measures affected the behaviour. Here, measure is a sudden action or gradual action that changes the behaviour of the variables but not their direction (i.e., towards a balancing state). The RBP includes two alternatives to show how health behaves (Figure 2.10): one is not more right than the other, unless more information is provided about how health deteriorated and recovered. The loops in the CLD can be used to generate a RBP according to the behaviour of the basic six graphical structures. All systems fall within the structure of linear or non-linear relations or through the combination of two or more diagrams. The behaviour in Figure 2.10 is also expected as the overall behaviour of a system contains a large CLD. The RBP is more often a combination of loop behaviours as will be illustrated in the following examples (Figures 2.9–2.11).

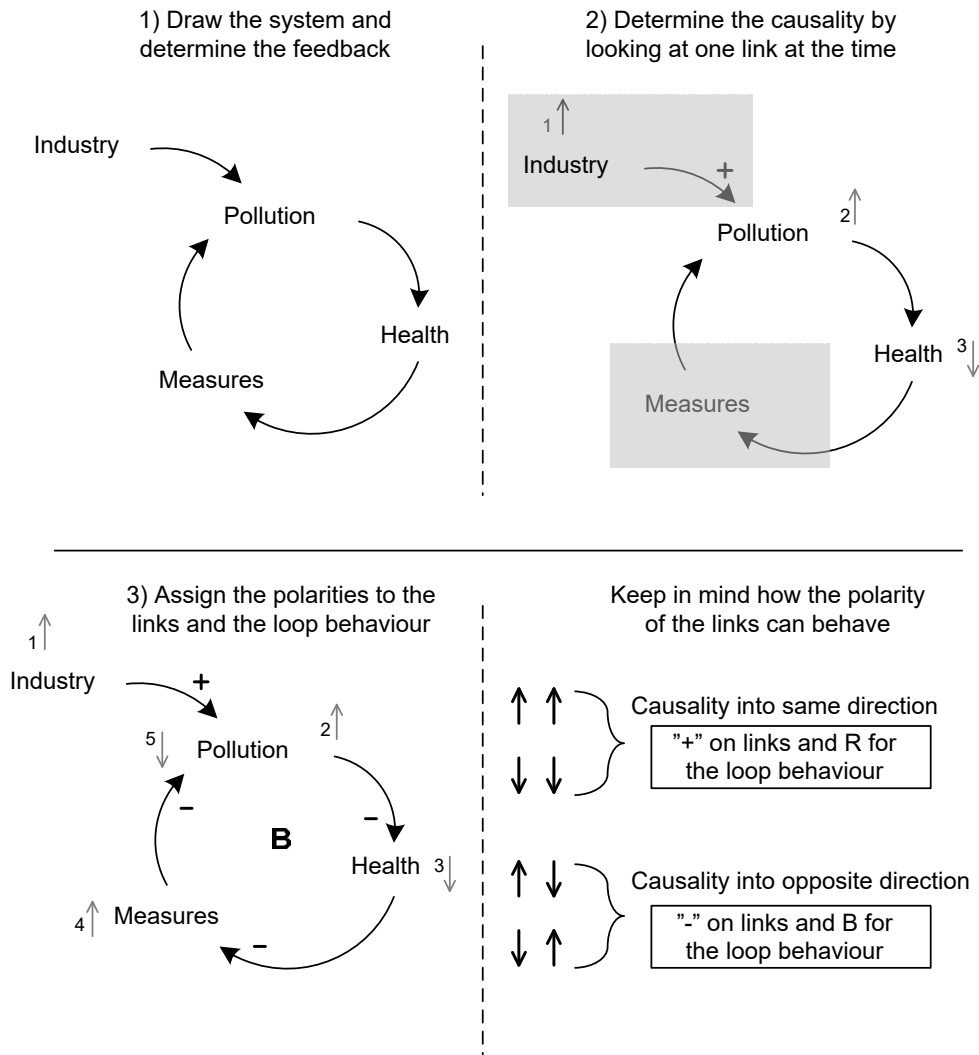

Figure 2.8. Assigning polarities and behaviours to a loop.

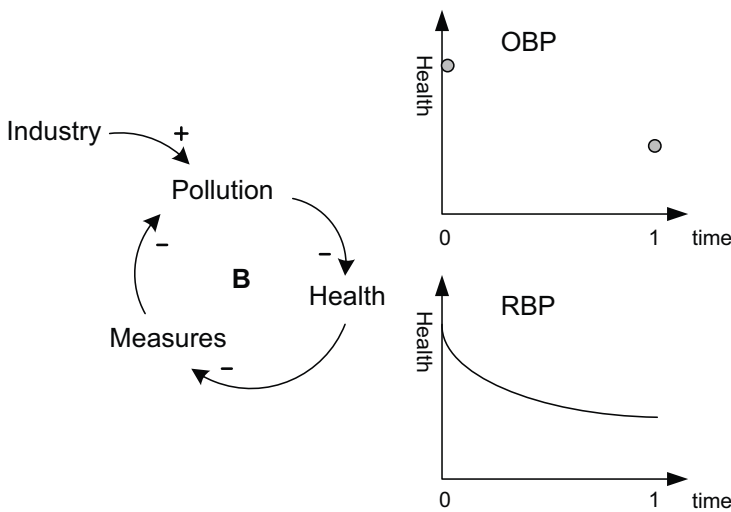

Figure 2.9. OBP and RBP are a useful way to understand how a system behaves.

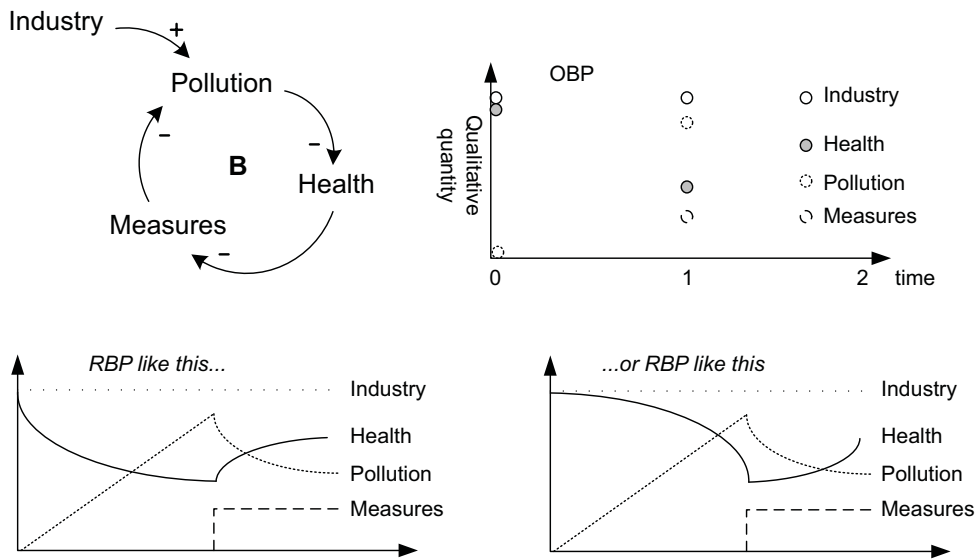

Figure 2.10. Different alternatives of RBP graph behaviour.

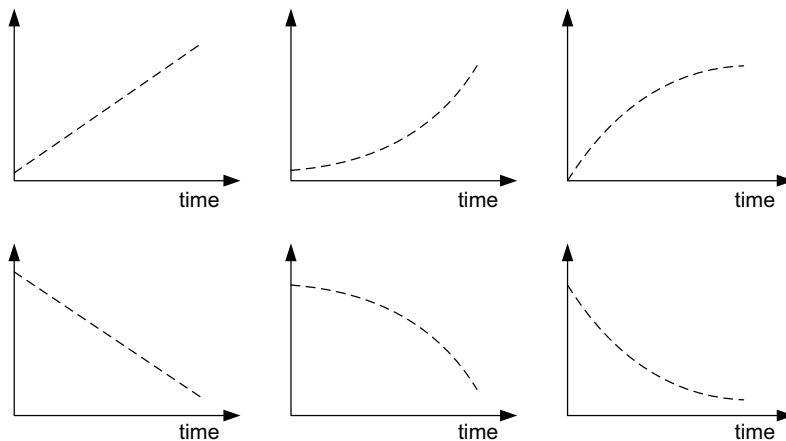

Figure 2.11. All loops and systems can be categorized in basic terms according to the above principles or the combination of the principles.

2.4 Delays

Everybody is familiar with waiting time such as standing in the line at the bank and waiting for a car to warm up on a cold winter morning. All systems have some kind of delay, which can range from seconds to days, centuries to millennia. Delays cause systems to fluctuate as an action between two components in a system is much slower than the rest of the system. For example, everybody knows that it takes time for shower water to become warm. Since it is cold in the bathroom, we want the water to become warm as quickly as possible, so we turn the shower tap wide open. However, it takes time for the water to become warm since the pipes in the house are long and the cold water trapped in the pipes has to travel some distance before reaching the

shower head. When the actual hot water arrives, it is so hot that we are forced to turn it down and increase the cold water tap, which results a blast of cold water. We continue until the water is just right for showering. The CLD of the water temperature and the RBP looks like the scenario depicted in Figure 2.12. As before, drawing the delay is a conceptual exercise to help illustrate how the delay affects the system. In the shower case, the delay is measured in minutes and we draw it between the shower tap settings and the water temperature since it is in that link where the water makes the journey to the shower head.

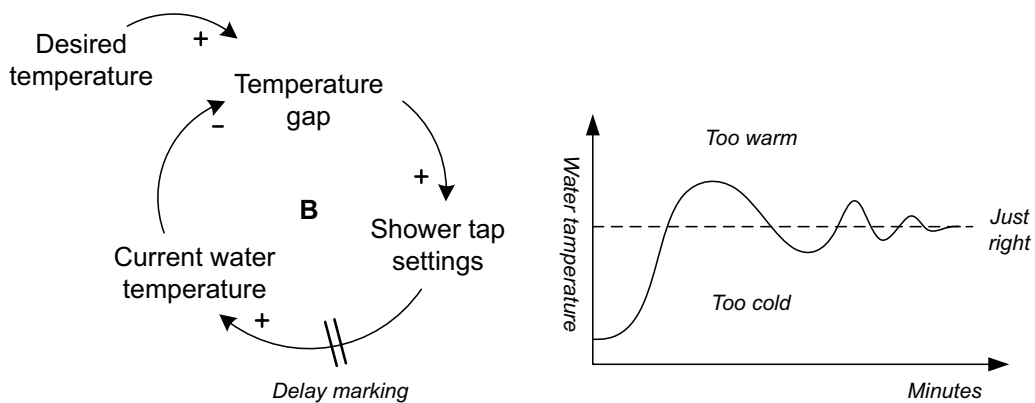

Figure 2.12. Showering and delays.

Delays are hard to predict. As most of the time we do not know how long a delay will be, we tend to use a trial and error approach to assess the delay time (as in the shower case). Typically, the longer the delay, the larger the oscillation and the larger the effect on the system. Long delays make analysis of a problem difficult as the feedback loops are easily missed, especially if feedback loops take longer to cycle than the observation time set aside. Therefore, it is crucial to identify the variables involved in long feedback loops. Decisions can often create instability and oscillations in the system that are not felt instantly. Thus, we might push some variables very hard without instant results. However, the harder we push the system, the harder the system pushes back. This is important to realise when considering long-term conditions.

2.5 Loop analysis

The steps from Causal Loop Diagrams and loop analysis to Stock and Flow diagrams. In the following examples, we will go through a simple CLD of a fictional nomadic human population on an island. As with any population, we can assume that the population is increasing and the individuals have a natural lifespan, so the observation span is at least one generation. Limited

resources are introduced that will affect the livelihood of the population by increasing the number of deaths.

A loop analysis is the first step in understanding the way a system behaves. By analysing how all the feedback loops affect the performance indicator observed, an approximate conceptual behaviour is produced from the CLD as a whole. The analysis reveals an indexed behaviour and how the parameters behave in relation to each other. The loop analysis helps predict how parameters will behave when we construct a numerical model. That is, loop analysis fact checks that the quantitative model structure reflects the mental model created in the first place.

A first draft of a CLD always starts with storytelling. The storytelling is a time sequence where the initial question for the problem starts as one parameter, creating the initial causality chain that iterates into the first feedback loops and ultimately the whole model. Storytelling is important for two reasons:

1. It keeps us focused on making the proper connection between the question and the key variable that starts the CLD.
2. It helps us structure the order of the loop influence on the key variable – i.e., in what order the different loops influence the variable behaviour.

Understanding the behaviour of the key parameters gives us a good idea of how our problem and the questions stated may develop in the near and far future. Preferably, storytelling through loop analysis is done as part of the modelling, but it can also be done at the end of the process to check whether the feedback loops are behaving as intended (i.e., as the logic that constructed the diagram determined). The logic and therefore the diagram is situation dependent.

In the following, we will analyse an example of over population and natural resource extraction to illustrate how storytelling influences the feedback loops. The storytelling helps us identify the variables that change over time and subsequently the ones that should make up the stock and flow diagram.

LOOP ANALYSIS OF OVER POPULATION AND NATURAL RESOURCE EXTRACTION

Here is the question posed: What is the behaviour pattern of a population that extracts a natural resource over time? The system boundaries are set around the population and an unidentified natural resource. Here, we go through the CLD step-by-step to show how to draw and analyse the CLD, to identify the CLD's point of departure, and to follow the CLD's behaviour in relation to RBP. Below is the complete diagram (Figure 2.13).

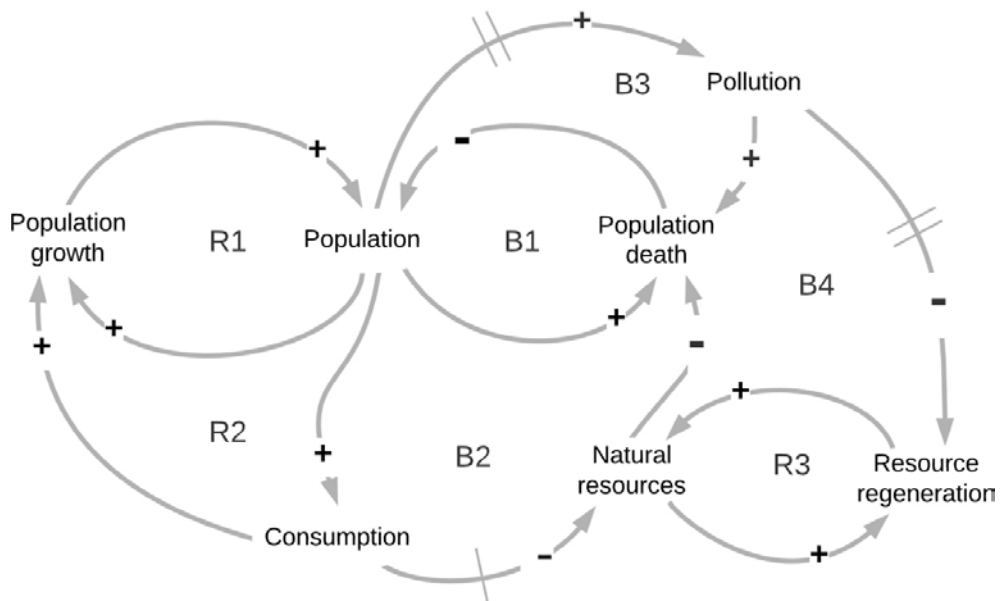

Figure 2.13. A complete CLD of the example overpopulation and natural resource extraction.

Here, the starting point is defined as the item population.

Step 1. Define the point of departure, starting with the variable population, and connect the variables population and population growth. Next, identify the loop behaviour, R1 (Figure 2.14).

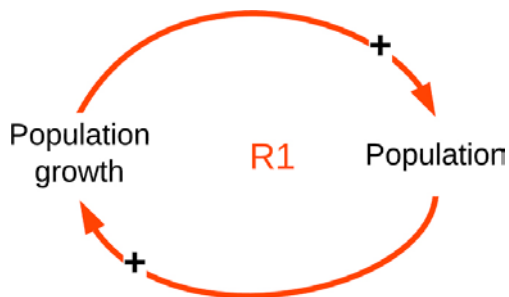

Figure 2.14. Step 1: Define the point of departure.

Step 2. Connect the variable population to the next variable, consumption, which leads to increased population growth. Then, identify the loop behaviour, R2. Draw the behaviour onto a time graph with the variable population on the y-axis and time on the x-axis. Read the loop's (shown in red) behaviour for R1 and R2 and draw the RBP onto the graph. As the variable consumption increases the variable natural resources gradually decreases, which is identified in the growth stage; add this to the x-axis (Figure 2.15).

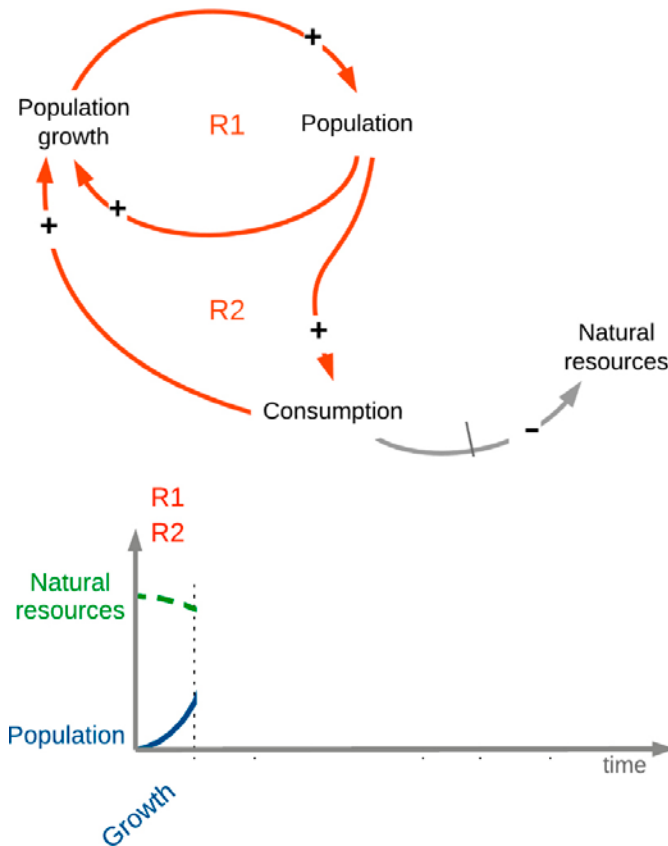

Figure 2.15. Step 2: Read through population that connects to the next variables.

Step 3. The increase in the variable population is balanced by an increase in the variable population deaths with the B1 loop behaviour (shown in blue), and the variable consumption reduces the variable natural resources with a delay. The B1 loop creates a saturation effect, which is indicated on the RBP (Figure 2.16).

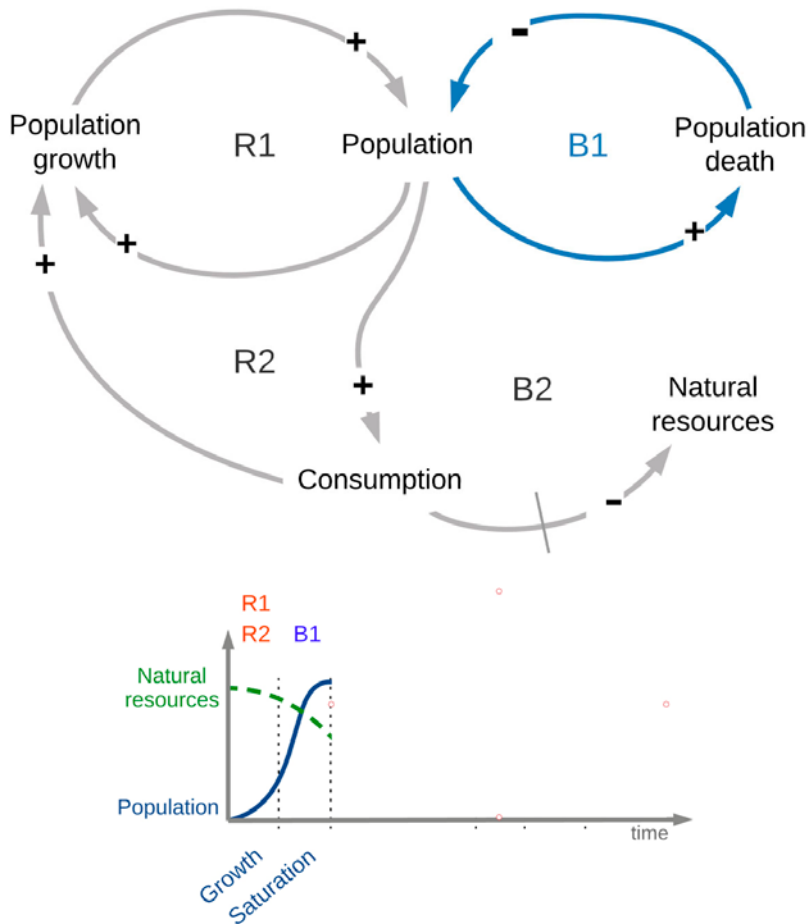

Figure 2.16. Step 3: The increase in variable population is balanced out by increase in the variable population deaths.

Step 4. As “the variable consumption reduces the variable Natural resources, the variable population death increases. The B2 loop (shown in blue) is set into motion. The effect of the feedback loop is a reduction of the variable population, which is drawn in the RBP graph and indicated with a decline phase (Figure 2.17).

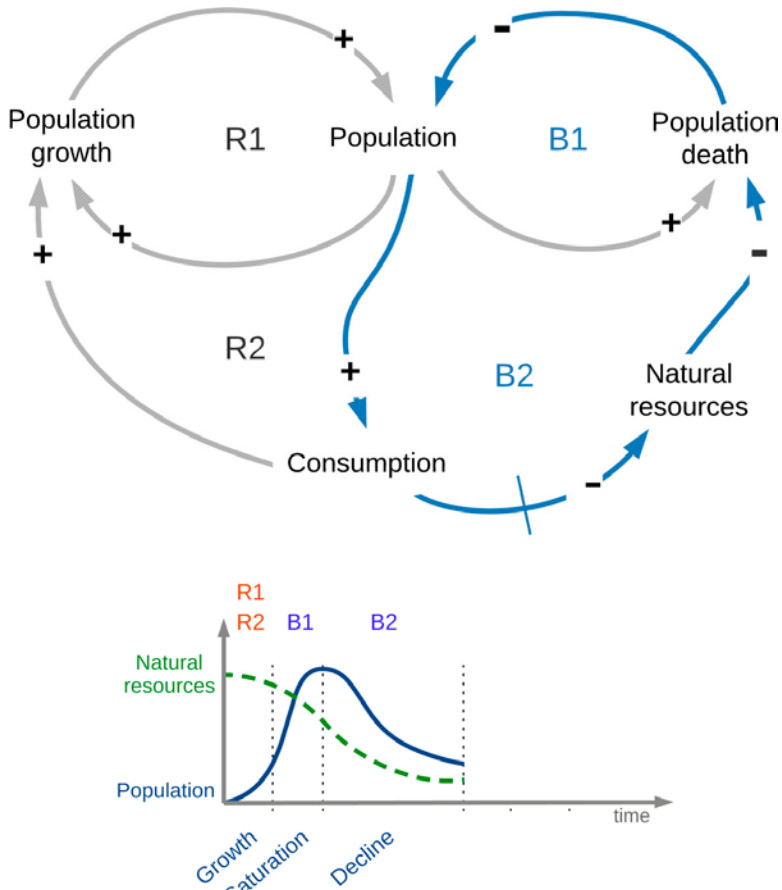

Figure 2.17. Step 4: As the variable consumption reduces the variable natural resources, the variable population death increases.

Step 5. As the variable population decreases, the variable consumption of resources decreases and the variable natural resources increases (i.e., an inverse relationship) over a longer time (indicated with a delay). As the variable consumption decreases, the variable natural resources increases as the result of the variable resource regeneration increasing, which is indicated by the R3 loop. As a result, loops R1 and R2 start to strengthen again. This is indicated as a new growth phase in the R1, R2, and R3 loops (Figure 2.18).

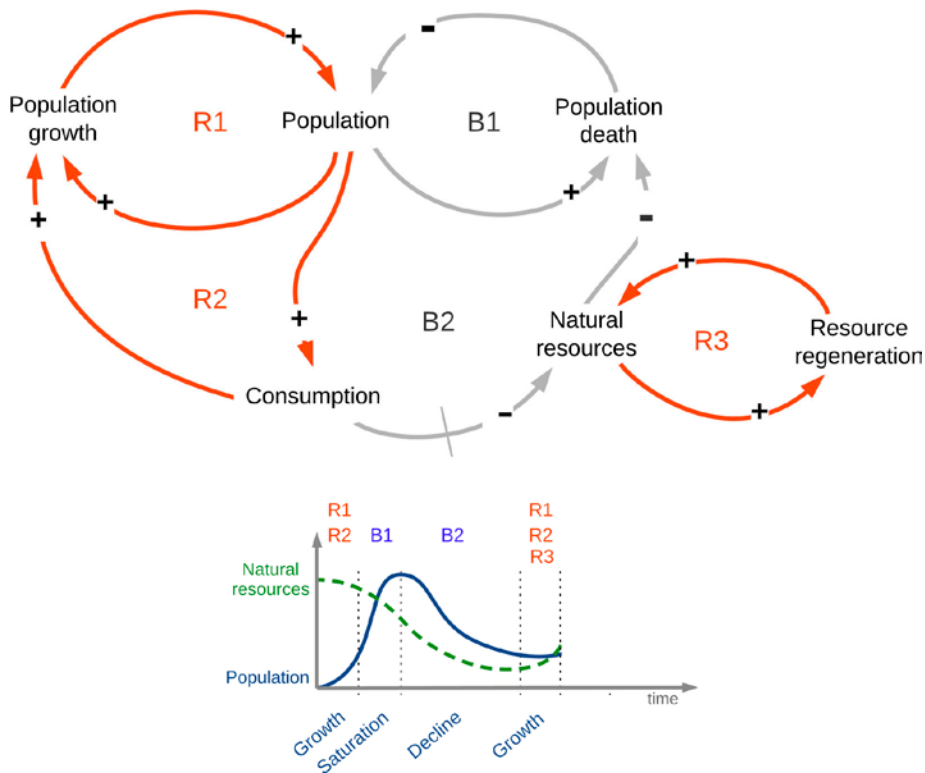

Figure 2.18 Step 5: As the variable population decreases, the variable consumption of resources decreases and the variable natural resources increases.

Step 6. When the variable population has reached a certain size, the B1 loop gains strength over the R1 and R2 loops. This is the second saturation phase that regulates population size as previously, but now the variable population and the variable natural resources are at a lower state. This is drawn onto the RBP graph to indicate of saturation (Figure 2.19).

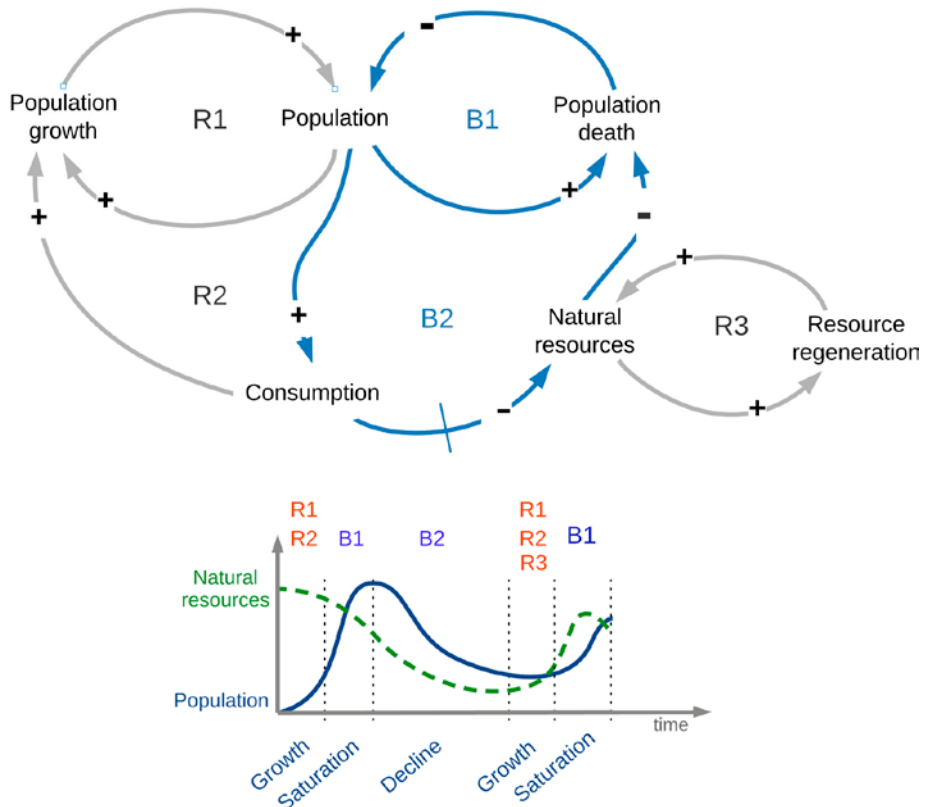

Figure 2.19. Step 6: When the variable population has reached a certain size, the B1 loop gains strength over the R1 and R2 loops.

Step 7. In step 7, two new loops come into play, the B3 and B4 loops. The variable population increases over a longer period (indicated with a double delay marking). In turn, the variable pollution increases the variable population death over a long period and reduces the variable resource regeneration. The B3 and B4 loops combine with the B2 loop to reduce the variables population and natural resources. This is drawn on the RBP as a decline phase (Figure 2.20).

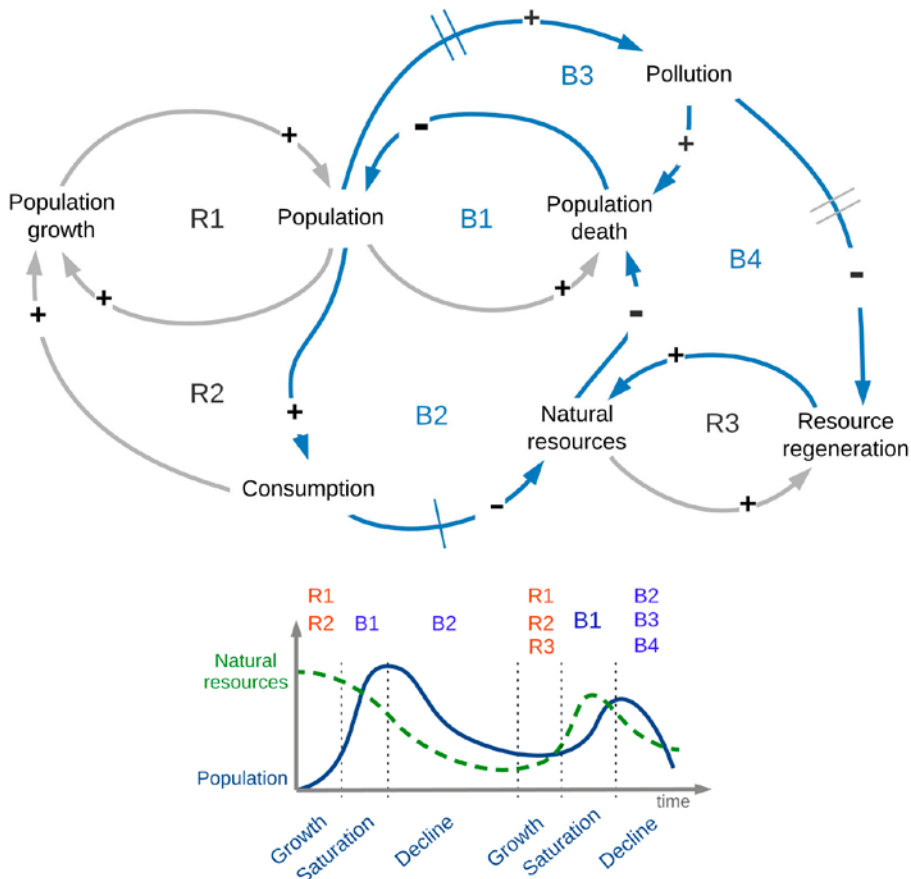

Figure 2.20. Step 7: Two new loops come into play, the B3 and B4 loops.

The storytelling in the loop analysis is an approximation and indicates direction of the loop behaviour. The exact curve or size or length of the drawn lines in the RBP is not important; however, what is important is the relative behaviour of the loop phases of the different variables and how they interact through the growth, saturation, and decline phases.

One powerful aspect of using CLDs is the possibility to analyse loop dominance in a system. Loop dominance describes which part of the feedback in our CLD is strongest or most active at a given time in the system. Since the CLD is a description of change, feedback loops may inactive until some of the variables are turned on. Even when drawn on paper, the CLD tells a story – i.e., tells the story from the starting point of our CLD to describe what happens when the variables are influenced by their causalities and other variables. This is where the RBP becomes a useful tool.

The first loop dominance is the population growth phase. The population is allowed to grow since the resources are abundant and the effect of reducing resources remains obscure for some time – i.e., there is a significant delay between the initiation of a cause and its manifest effects. When the feedback “kicks in”, the loop dominance becomes the decline of population as the result of increased mortality. Importantly, the resources – e.g., fish – are also a population that needs to recover. Therefore, the number of deaths continue for some time until, for example, the number of fish can sustain the human population. The RBP qualitatively expresses the levels when the population stabilises and when the growth phase of the population re-starts. In Figure 2.21, the fish population is hidden from the human population, so how the fish population behaves cannot be perceived.

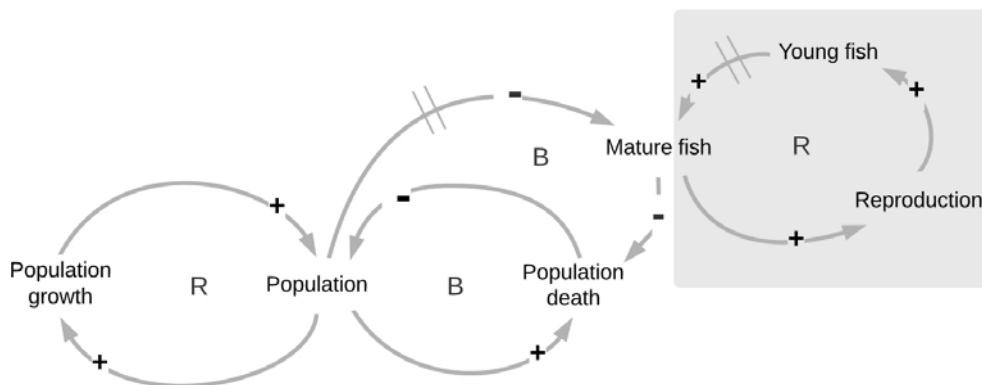

Figure 2.21. The fish population is hidden from the human population.

Furthermore, the human population catches only mature fish stock, further obscuring the behaviours of fish and the total stock of fish.

2.5.1 Analysing the loop behaviour of conflict using RBP

Observing a RBP can also be done by looking at each loop in the CLD as isolated and drawing the behaviour for each one of them. The sum of the results from each of the loops is then used to predict the RBP from the whole CLD. Let’s look at a short story about diplomatic skirmishes between two communities.

Coruscant and Tatooine are planetary societies that frequently engaged in skirmishes over intergalactic trade routes. The United Galaxy Council (UGC) tries to terminate the skirmishes as quickly as it can. Because the Coruscantians feel threatened by Tatooinians’ expansions in trade, they behave aggressively towards Tatooinians to block and terminate their potential contracts. The Tatooinians usually retaliate aggressively towards Coruscantians, but this retaliation ends up being penalized. That is, the Tatooinians are punished for the skirmish that originated with aggressive actions of the Coruscantians.

This problem can be framed using the following question: What effect does the United Galaxy Council's actions have on aggression?

It can be helpful to create a string of events for a problem as the starting point of a CLD. Strings of events are basically a sequence of how one event results in another event in the problem. Often, we draw a string of events to illustrate how the behaviour of the problem is documented (Figure 2.22). We can use this documentation of events to help construct the CLD before identifying how many feedback loops are involved in the problem. In this case, there is one reinforcing loop (R1) and two balancing loops (B1 and B2), which feedback back into R1 (Figure 2.23).

Reading the diagram starts with the variable Coruscant feeling threatened as this variable fuels the conflict that causes Coruscantians to act aggressively towards Tatooinians, increasing Tatooinians' aggression toward Coruscantians. When Tatooinians become aggressive, Coruscantians file complaints with the United Galaxy Council (the more aggressive, the more complaints). Due to increased complaints, the UGC forces Tatooinians to cease their aggressive actions. This intervention by the UGC decreases the threats from the Coruscantians and therefore their aggressive tactics.

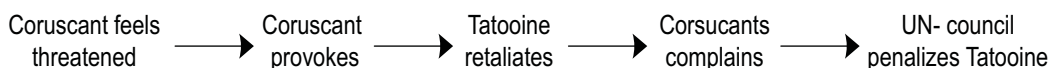

Figure 2.22. String of events of a community conflict.

Because the Coruscantians start the conflict, we can use Coruscant aggression as an observation variable in the RBP (Figure 2.23). In the RBP, the behaviour of each loop can be used to estimate how aggression will develop through the entire loop. When the CLD is read, we read through three loops (R1, B1, and B2) that have their special behaviour in the CLD. We can use this information to map the causal links onto the RBP diagram. Since time is not important, it is possible to use causal links to represent each time step (Figure 2.23). Therefore, one CLD cycle is the number of causal links from the starting variable until it feedbacks into the loops. Figure 2.24 has ten links – i.e., five links that reinforce the aggression (the whole loop around) and five links that allow the feedback loops to reduce the aggression again. The pattern repeats itself in the second cycle. Note that the small RBPs are superimposed onto the graph (in the first cycle) to help identify where they kick in.

The reinforcing loop is active for the first five steps; thereafter, the balancing loops take effect. To read the behavioural cycle, you must read through the loop two times. All the variables in the CLD will have the same behaviour as the observed variable, either in or out of phase with it.

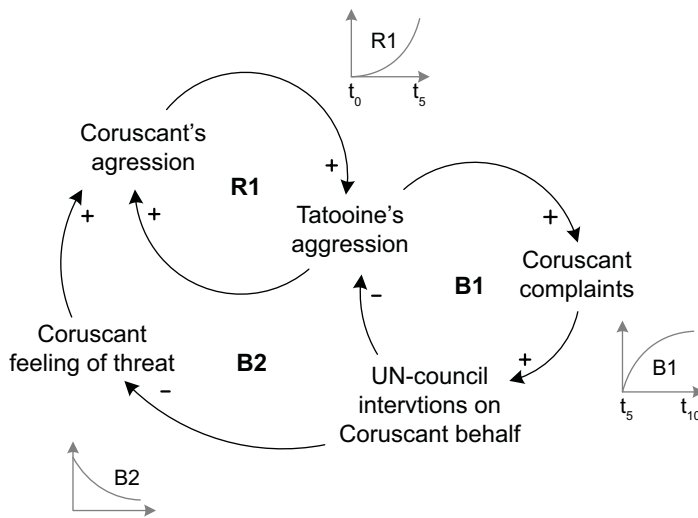

Figure 2.23. A small RBP behaviour is extracted from each loop and time sequenced.

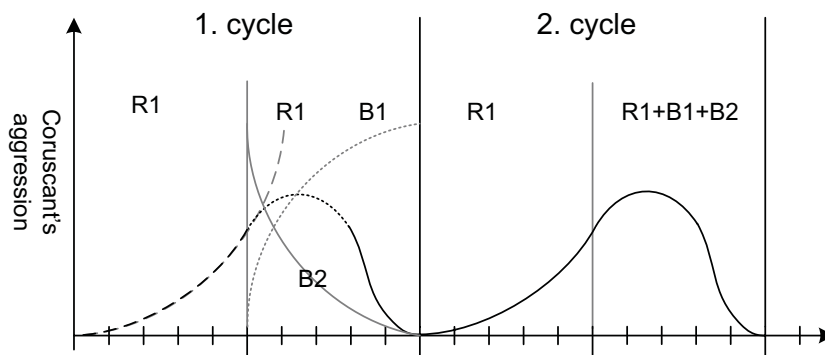

Figure 2.24. By superimposing the small RBPs onto the graph, it is possible to abstract the behavioural cycle out of the causal links.

2.5.2 Analysing the loop behaviour of riding a bicycle

Let's look at another example of loop behaviour. This example involves a young boy riding a bicycle.

John is riding his mountain bike in the country one beautiful morning. After several stunt tricks and jumping, he discovers that he has damaged the rear tire. He can hear a hissing sound of air passing through the tire and he recognises that soon the tire will be completely deflated. If he wants to bicycle home, he needs to pump air into the tire several times on the way. But this action will also damage the tire further by increasing the size of the hole and therefore deflating the tire more quickly each time it is inflated.

Here is a question that frames the problem: What is the effect of inflating air into the tire?

In the first cycle (Figure 2.20), the loop B1 is the only active loop since we start by reading through the CLD from that variable. Next, B1 and B2 are

activated simultaneously since the inflation is delayed before the tire is full of air again. In the second cycle, the deflation is faster since loop B1 and B2 are acting together.

The RBP assumes that larger effort is put into inflating the tire to keep the tire fully inflated, which is illustrated with the steeper and longer curve as more cycles are iterated. The analysis of the actions is done by constructing the strings of events, which can be used to construct the CLD (Figure 2.25). This move is done to understand the documented sequence in the story: how the bicycle riding caused the damage and deflated the tire.

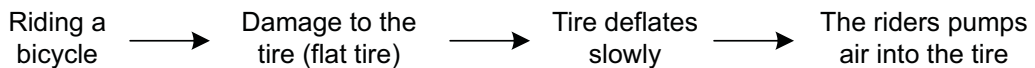

Figure 2.25. Strings of events of riding a bicycle.

Here the CLD needs to address what variables affect the air in the tire, the amount of air supply, the bicycle ride, and the damage to the tire. The causal loop in Figure 2.26 relates to the air, so our RBP should focus on reading through the diagram starting with the variable air stock (Figure 2.27).

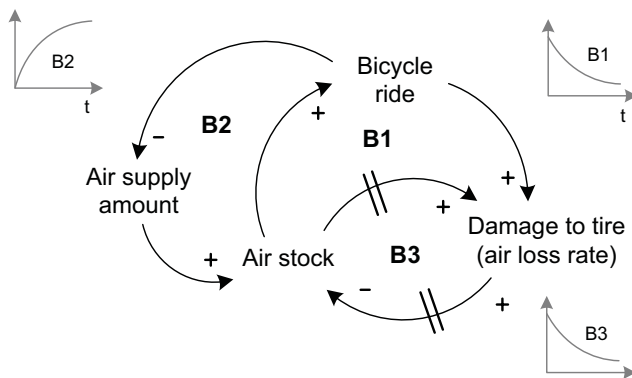

Figure 2.26. The bicycle ride and the attempt to keep the tire inflated. A small RBP behaviour is extracted from each loop and time sequence.

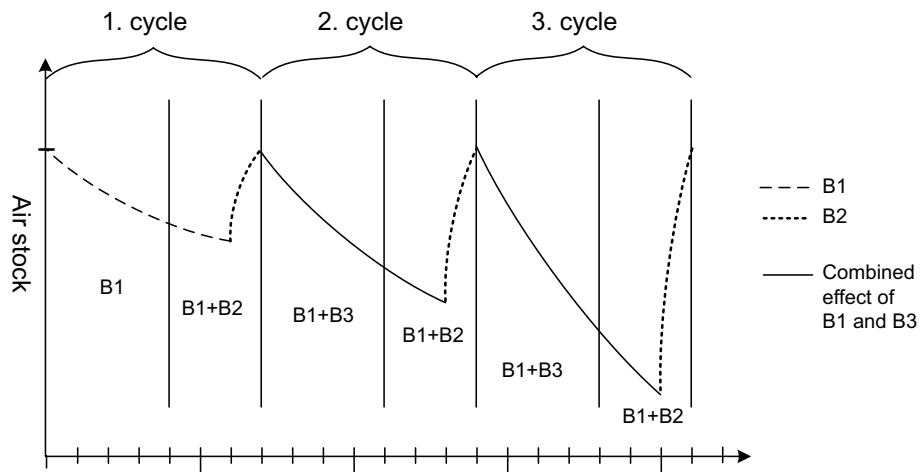

Figure 2.27. When the small RBPs and the time sequence have been determined, an overall behaviour of the CLD can be created by combining the time sequences and the graphs.

The bicycle CLD reads as follow. Bicycle ride causes increased damage to the tire, which is interpreted here as a larger hole in the damaged tire and a higher air loss rate. These events decrease the air stock in the tire but only after a delay because the hole is small. The reduced air stock causes the rider to stop his pedalling. He increases the air stock (through pumping). This action allows the rider to continue the bicycle ride. However, increased air stock increases the size of the hole in the tire and this results in a higher air loss rate. This sequence of events represents one cycle in the CLD. Once again, we can use the number of causal links to construct the RBP (Figure 2.27). We read the delays as at least two causal links so loop B1 has four links and loop B3 has four links. Air stock decreases as the result of riding the bicycle and pumping air into the tire.

2.5.3 An example: Analysing the loop behaviour of the Mouse Empire

Let us now look at a system that has a dependency on another system. Suppose there is a mouse population confined within a small space (e.g., a room). The population depends on only one food source for its survival and the food is only available for a limited period. The food source is a large loaf of bread in a net hanging from the ceiling inaccessible to the mice. However, this bread breaks apart as it ages. Soon, pieces of bread fall onto the floor. The pieces are large enough to support the first couple of mice and they begin to reproduce, creating a Mouse Empire. We could frame the problem with this question: How long can the population sustain itself and what would the population graph look like?

To answer this question, we need to identify two systems: the mouse population and the food supply. Because the bread is not affected by the mice, only the aging process, the direction of causation goes in one direction: from the food supply to the mice population (Figure 2.28). The loop in Figure 2.28 tells the following story. As the bread in the basket ages, pieces of the bread fall to the floor. This is good news for the mice trapped in the room as the mice can live off these pieces of bread. Since the mice are trapped in the room, the fallen bread allows them to populate the room. Eventually, however, the bread supply will be depleted and the mice will die.

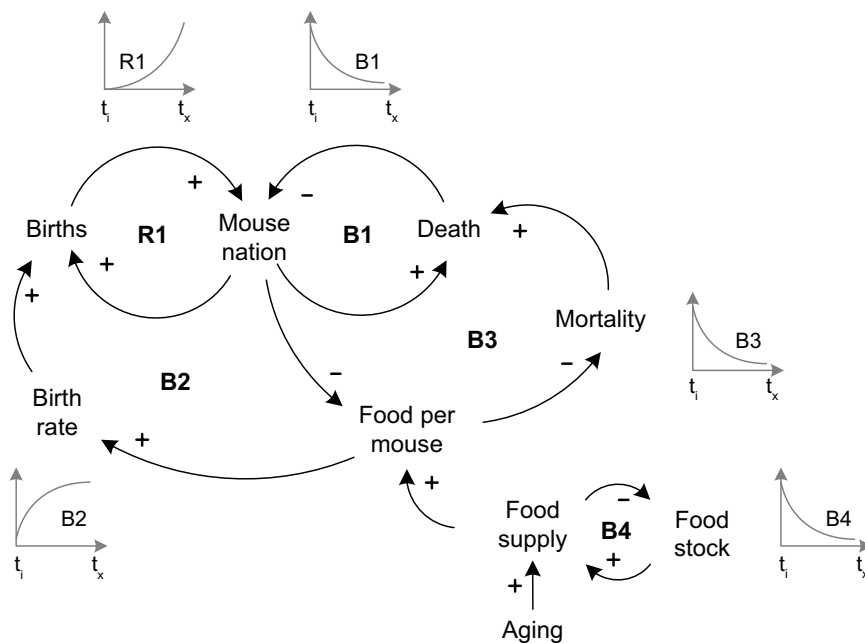

Figure 2.28. The CLD for the Mouse Empire is constructed of two loops (population and food stock) that are only connected in one directional link. That is, the mouse population is affected by the amount of available food, but the available food is not affected by the mice.

Drawing a RBP of the story could resemble the diagram in Figure 2.29. There is a population increase phase as long as the bread falls on the floor. When the food stock is exhausted (i.e., the last pieces of the bread are eaten from the floor), the population will no longer increase. The latter phase of the diagram shows the decline in the population – i.e., when the mice begin to die due to starvation. What is interesting about this diagram (compared to the previous examples) is the fact that the cycle is non-repeatable as all the events are unique (i.e., all the bread is consumed and all the mice die). The cycle cannot be repeated unless a new pair of mice is introduced and a new loaf of bread is suspended from the ceiling. It is not important to know the exact length of the time steps or how steep the decline of the population should be as such knowledge is only approximate. The important factor here is to learn the behaviour of the system. If numbers are important, it is possible to carry the CLD structure into mathematical modelling. Then the actual slopes of the curves could be learned. By creating causal loop diagrams and identifying reference behaviour patterns, we can predict the overall behaviour of the system and how the sequence of the causal links will behave. The only thing we cannot determine is the time delay itself, i.e. if it is, seconds, hours, days, years etc. To determine the time delay, we need to perform computer simulations. Later, we will practice using simulation exercises, starting with the smaller simulations, using the above examples as a guide to solving the exercises.

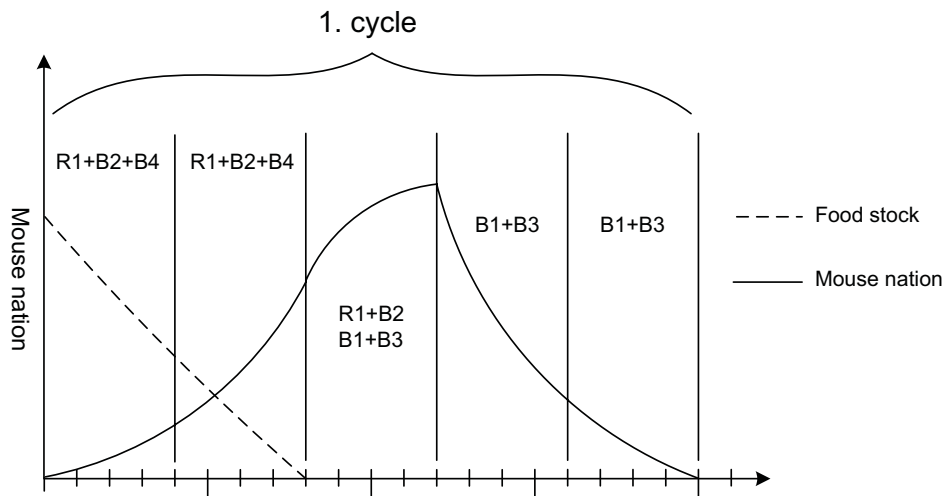

Figure 2.29. A RBP of the mouse empire. The diagram does not show repeated behaviour but events that are conditioned such as the food source being exhausted.

2.6 Working with the CLD and flow charts

2.6.1 Seeing the Learning Loop

A causal loop diagram is only interesting if it answers the right questions posed by a problem. How we understand a problem is how we ask the questions. When we start working with a problem or an issue, several steps need to be followed to effectively analyse the problem using the CLD (Figure 2.30). First, the problem needs to be defined – i.e., the problem has to be specific enough to create boundaries and to contextualise.

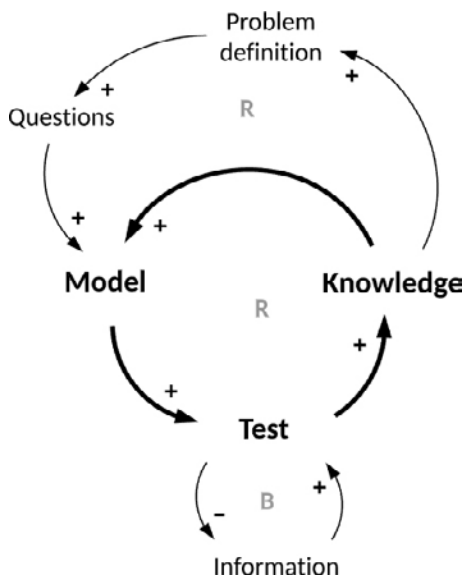

Figure 2.30. We use the learning loop as a roadmap to design the CLD and aid us in the process (adapted from Haraldsson and Sverdrup, 2004).

Typically, only the symptoms of a problem are visible, not the problem itself. That is, a description of a problem is really a description of behavioural symptoms emerging from the problem. Our task always starts by defining the problem and the problem's symptoms. Here, the use of group work is invaluable as it brings together different viewpoints about the same problem that in concert can be used to identify the hidden links. Therefore, the more diverse the group is, the more likely the links will be identified. Group work should never be downplayed since it always creates better insight into a problem than an individual could do working in isolation.

We have to remember that the insight created into the problem is only as good as the group's understanding of the issue. For example, a group of mathematicians, astrophysicists, and engineers can do their best to understand an illness on a cellular level, but they will never be able to create the necessary insight into the problem as medical doctors. They could only provide a superficial understanding of the problem, so for the group to succeed it would have to have the necessary background knowledge in medicine. Including a medical doctor in the group would greatly advance their understanding of the problem and improve the chances that the right questions are asked.

The ability to ask the right questions depends on the ability to put together a group of people with sufficient background knowledge to accurately define the problem and therefore have the ability to formulate questions that frame the problem. We have to remember that the CLD reflects our understanding of the problem, so defining the problem and the questions asked of the problem are reflected in the CLD. The old saying "All models are wrong, but some are useful" refers to our ability to avoid the superficial interpretation of a problem while maintaining a sense of humility about the power of the model. Usually, reading extensively about an issue can be sufficient for gaining some insight into a problem, since we can recognise behavioural feedbacks in similar problems and apply our experience to how the problem will behave. It is important to recognise that formulating a question for a problem is the same thing as formulating a hypothesis.

Below is the list of the steps involved creating a CLD.

Define the problem

Here, we describe the circumstances and define the problem, including how the problem manifests and what it is doing. We also define what the system boundaries are and frame the problem by describing what it includes and it excludes – e.g., polluted air from heavy industry is causing health problems within the city of Springfield. We also define the time horizon and the geographical scale – e.g., the city Springfield is situated in a narrow valley enclosed by mountains on three sides and the industry has been active for 30 years.

Ask the question

The question is central for analysing the issue as it helps properly define the boundaries. All questions deemed relevant should be identified. Typically, one overall question and several sub-questions will emerge from the in analysis. These questions are used to define the specific purpose of the analysis and to formulate answers to the problem: What type of industry is causing the pollution?; How does the pollution cause the health issue?; What options exist to reduce exposure, reduce emissions?; Can we have this type of industry in the city? Remember, one problem might require several questions, but the general rule is one question, one CLD. That is, each question requires one CLD.

Define the goal and the success

Once the problem is defined and the questions formulated, define the goals and success of your analysis by comparing the current state (e.g., health problems) to the desired state (e.g., no-health problems). Here, the goal is for the citizens of Springfield to not experience any health problems and the success is defined when no harmful emissions are coming from the industry. The distance to target is then the time it takes for people to get healthy, and the measurement of success is when emissions are eliminated that cause the health problem.

Sort the main actors

Create a list of relevant variables using nouns, verbs, and adjectives that are part of the defined system (inside and outside the system boundaries) and sort them into an order according to their importance to the question and the goal; list the most important variable first, the least important last. Create a longer list of variables than you think are important and then take away the unnecessary ones once you have an overview, typically between eight and ten variables. Starting with fewer variables is usually best.

Start a simple CLD

Have a “point of departure” where you start drawing the CLD. Typically, the point of departure is determined by choosing the questions that will be easy to analyse. Draw links between the variables you selected in a causal chain – i.e., draw lines between variables that influence the sequences. Identify where feedback loops exist, draw these loops one at the time, and check to make sure these loops are reasonable. Always check a link if there is a link back (feedback) to other variables. Continue until a loop is created. Usually, it is better to start with nouns and verbs before using adjectives or adverbs when describing controls. Often, during the drawing process new variables are discovered. Continue with this process until a first version of the CLD is complete.

Create a Reference Behaviour Pattern (RBP)

Use a RBP to explain the behaviour in the model. It is not important to draw all the variables, but the most important variables affect success and show distance from current state to target (i.e., decrease in harmful emissions and increase in health). The point is to show how the combined loops affect the variables.

Test the CLD model

After the first CLD version is checked for consistency, perform the “reflection stress test”: If you find yourself puzzled or need to over-explain the result, then clearly something is lacking or wrong with your assumptions. Ask others for feedback and test your understanding on them or use the literature. Use the RBP to explain to them how the variables behave in the model.

Learn and revise

Although an agile and iterative process, CLD construction is never right the first time. The discussions should provide a new insight and new questions. Often, the CLD is revised according to the new information and these revisions influence the interpretation of the results.

Conclude

The final version of the CLD is often the result of many iterations. The conclusions are formulated by referring to the answers to the initial question. However, often the conclusions actually change the initial question as the iteration process can change the definition of the problem and therefore shift the focus of the question.

If working alone, explain the CLD to someone who has not been involved in the process: explain the problem (including how the definition was determined) and the question (including the rationale for the question). This person is likely to ask how or why the links were added. This outsider perspective should help you reconsider and clarify your thinking about how the CLD is structured, including issues related to cause and effect. Explain the CLD as “my” understanding of the problem and ask your new partners to help you understand how your understanding differs from their understanding. We often expect others to think the same. Asking for feedback is a way to check if the thinking is logical. The CLD building process can be described as a learning loop. The learning loop is our roadmap to the problem to see where we are in the process of learning. Developing a mental model involves the whole process of identifying, sorting, and drawing the variables into a CLD. The model behaviour is then tested on historical data. When we make conclusions, it is a result of the knowledge and understanding that is available at a specific time. When a new insight is developed, the problem needs to be redefined (including formulating new questions), pushing this iterative process further (Figure 2.31).

Advice on how to phrase the CLD and avoid pitfalls

Drawing a CLD requires practice to develop the skills needed to gain insight and understanding into a problem. A CLD can only be useful if it is interpreted correctly. Remember, the CLD is a reflection of our reality, not the reality of the CLD. We need to understand the following pitfalls associated with drawing a CLD (modified from Richardson and Pugh, 1981).

Variables should be self-explanatory

The variables in the CLD should be nouns or noun phrases, not verbs. That is, the variables should represent measurable quantities that can fluctuate (e.g., litres of water, population, and money). These measurable quantities help keep the focus on the story the diagram is revealing.

Remember, the action is in the arrows

Use neutral variable names and let arrows tell the action in the story. For example, if spending increases and money decreases as a result, use an arrow (polarity) rather than a word to convey the decrease.

Clarify the actions

Make it clear what a variable does when you send an action through (i.e., when an arrow is used). For example, write 'tolerance for crime' rather than 'attitude toward crime' as 'tolerance' is a more specific descriptor than 'attitude' (i.e., 'tolerance' and therefore 'intolerance' fall under the category 'attitude'). In addition, rather than using causal links to mean 'and then', simply interpret the link as an increase or a decrease.

Always use units

If no units are attached to the variables, invent some. Psychological variables are difficult to quantify, but using a scale (e.g., 0-100 or a Likert-like scale where numbers represent a range of responses from, for example, definitely not, not likely, likely, very likely, and definitely yes) is an acceptable way to define units. This is useable when dealing with dimensionless variables such as happiness, anger or stress.

Use positive wording

Use positive expressions when labelling variables as experience suggests that users of the diagrams find positive expressions easier to interpret than negative expressions. When reading polarities in a loop, positive expression creates a better flow for the reader, whereas negative expression tends to create a double negative in the interpretation.

Avoid double explanations of variables

If there is more than one event in a variable when an action runs through it, make these events new variables and explain what they do.

A loop has to have a feedback, if not, it is not a loop

Remember, only classify a feedback loop as reinforcing or balancing if it is circular. The figure to the right is a pseudo-loop as it does not contain any feedback as it does not feedback into the variable people moving to town.

Do you find it difficult getting started ? If so, start with the flow chart. Alternate between the flow chart and the CLD until they are 100% consistent.

2.6.2 A short introduction to flow charts

Let's return to the Mouse Empire, specifically in terms of creating a flow chart. A flow chart maps the flows in a system, which are usually divided up according to individual substance or entity (defined as stocks) that flow. Two entities flow in the Mouse Empire: food and mice (i.e., the biomass of both the food and mice). The flow chart for the bread is very simple. The bread is suspended from the ceiling, slowly decomposes, and pieces of the bread fall to the floor either to be consumed by the mice or decompose further. The entity flowing here is food units (Figure 2.31).

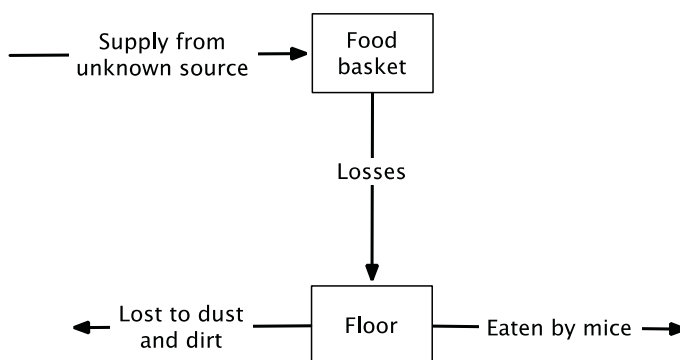

Figure 2.31. Flow chart for food in the Mouse Empire case. Food flows to the basket, crumbles, falls to the floor, and is either eaten by the mice or decomposes.

A flow chart can also be constructed for individual mice (Figure 2.32). It is important that we define exactly what is flowing. In this, the individual mice are flowing, not kilograms of mice or any other unit.

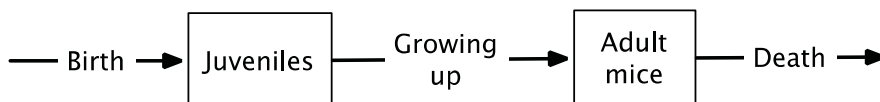

Figure 2.32. Flow chart for mice in the Mouse Empire. Mice flow into the system when they are born and flow out the system when they die. Note that there is no flow of individuals from adults to juveniles (time/entropy only goes in one direction). The adults create the juveniles, but adults do not become juveniles.

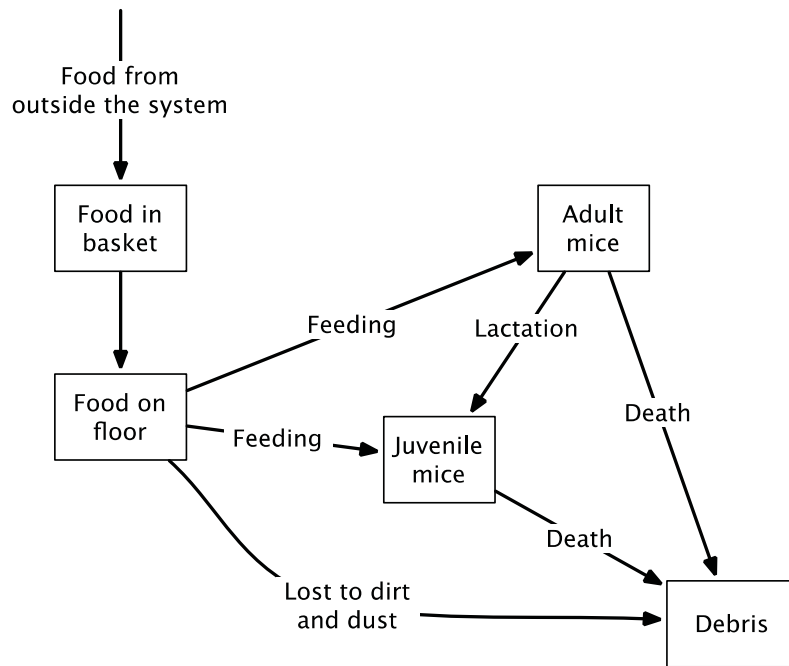

Figure 2.33. Flow chart for biomass in the Mouse Empire. Food flows to the basket, crumbles, and falls to the floor where it is partly eaten by the mice and partly lost to decomposition.

Table 2.1. Sorting table.

Items	Actions	Controls	Controls again
Food in basket	* Losses	* Hole in basket * Food in basket	
Food on the floor	* Input from losses from the basket * Eaten by mice	* Juvenile mice * Adult mice	
Juvenile mice	* Birth * Growing up * Juvenile death	* Adult mice * Birth rate * Rate of going from juvenile to adult * Juvenile death rate	* Food eaten by juvenile mice
Adult mice	* Growing up * Death	* Rate of going from juvenile to adult * Death rate	* Adult mice * Food eaten by adult mice

Items -	Actions +	Controls	Controls again
Food in basket	* Losses	* Hole in basket * Food in basket	
Food on the floor	* Input from losses from the basket * Eaten by mice	* Juvenile mice * Adult mice	
Juvenile mice	* Births * Growing up * Juvenile death	* Adult mice * Birth rate * Rate of going from juvenile to adult * Juvenile death rate	* Food eaten by juvenile mice
Adult mice	* Growing up * Death	* Rate of going from juvenile to adult * Death rate	* Adult mice * Food eaten by adult mice

Figure 2.34. The causal loop diagram drawn using information in Table 2.1.

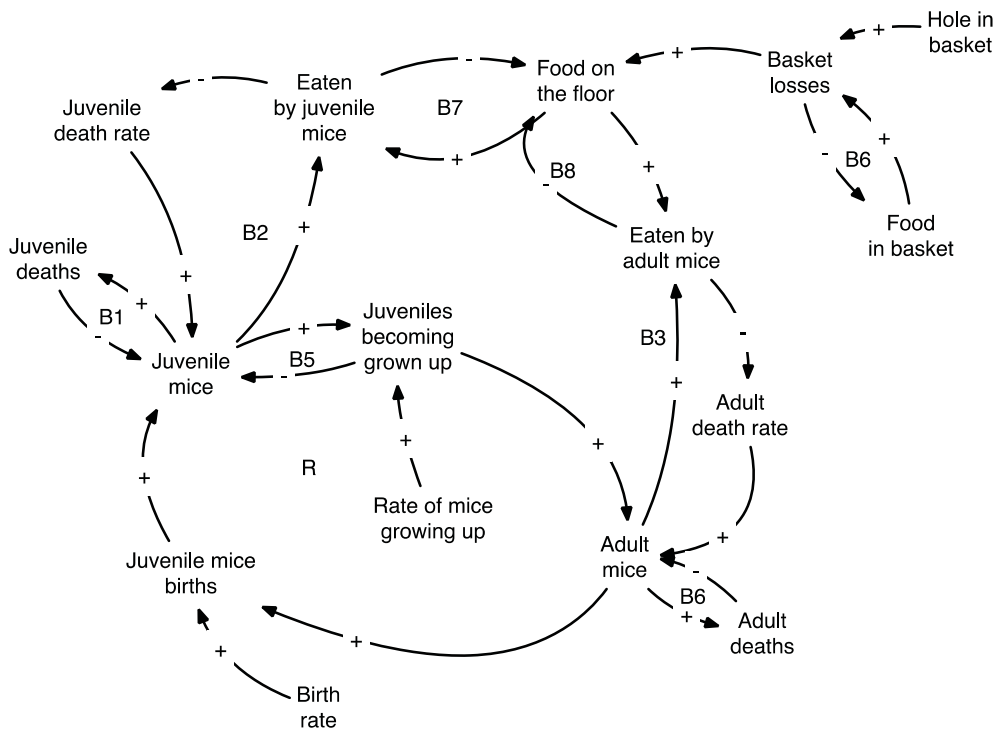

Figure 2.35. The causal loop diagram for the Mouse Empire using data taken from the Table 2.1.

We may also map the flow of biomass in the system. This has been illustrated in Figure 2.26. Both food and mice are composed of biomass. Now the flow-chart is defined in kg of biomass, including food, mice, and the decomposed products of both.

We use this information to complete Table 2.1, distinguishing between items acted on, actions involved, and what controls these actions. From Table 2.1 and Figure 2.35, we can construct the CLD using the links in the table and looking at the flow chart in Figure 2.33. In Table 2.1, the causal connections could be drawn in to reveal the causal loop diagram shown in Figure 2.34. This approach, however, produces a complicated shape, so it needs to be redrawn to make the causal connections and causal loop diagrams more easily read (Figure 2.35).

2.6.3 An example: Analysing the behaviour of the dog and the man

We will return to an example mentioned early: The man that disliked dogs and steadily ended up in fights with them. This scenario is repeated in Figure 1.14 below.



Figure 2.36. As we are about to learn, kicking a dog will have consequences.

We start by identifying the factors involved.) As you recall, the man has a prejudice against dogs. He is likely to kick one if he gets near one. Some dogs are afraid, but not all. Some become aggressive and bite. After the first bite, the man gets more angry and kicks again; now a fight ensues. How will it evolve? We have mapped some of the factors that come to our mind in Figure 2.37.

Items (nouns)	Actions (verbs)	Controls (intensities, adjectives)	Comments (Assumptions I make)
Man's anger	Kick dog	Prejudice against dogs	Is there from beginning
		Pain in the leg from dog-bite	
Dog's anger	Bite man's leg	Pain in the dog because of being kicked	

Figure 2.37. Sort the factors identified in the Items, Actions, and Controls.

After we have filled in the table in Figure 2.37, we start to connect the causal links, as they are presented in Table 2.1. After checking all connections, the result can be drawn as a clean causal loop diagram as in Figure 2.39. First, we get the diagram shown in Figure 2.39a. But we need to determine if any decisions are made in this system? Indeed, there are, so these need to be added. Figure 2.39b includes the decisions made by the man and the dog: to kick or not to kick and to bite or not to bite.

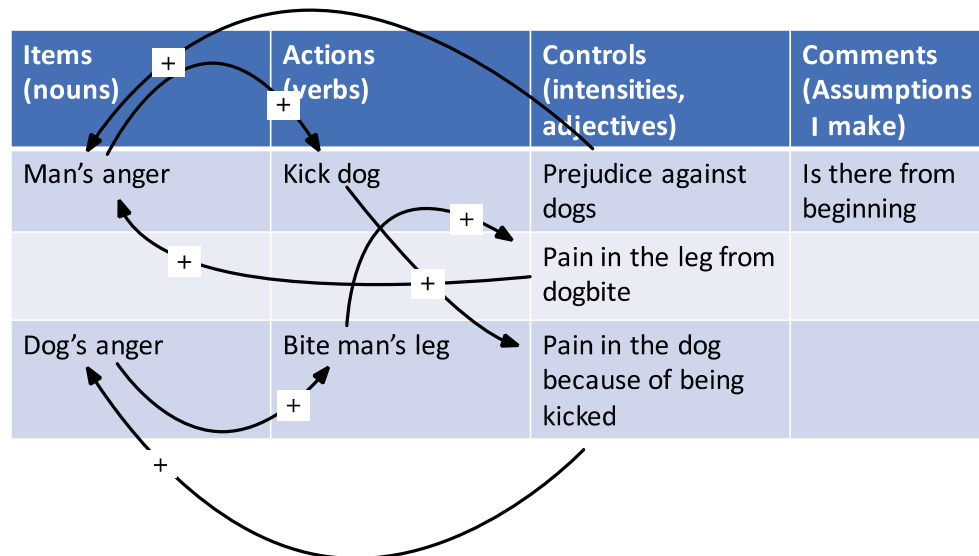

Figure 2.38. Connect the factors listed in the table. This forces the causal loop diagram to emerge. The method takes some time, but it always works.

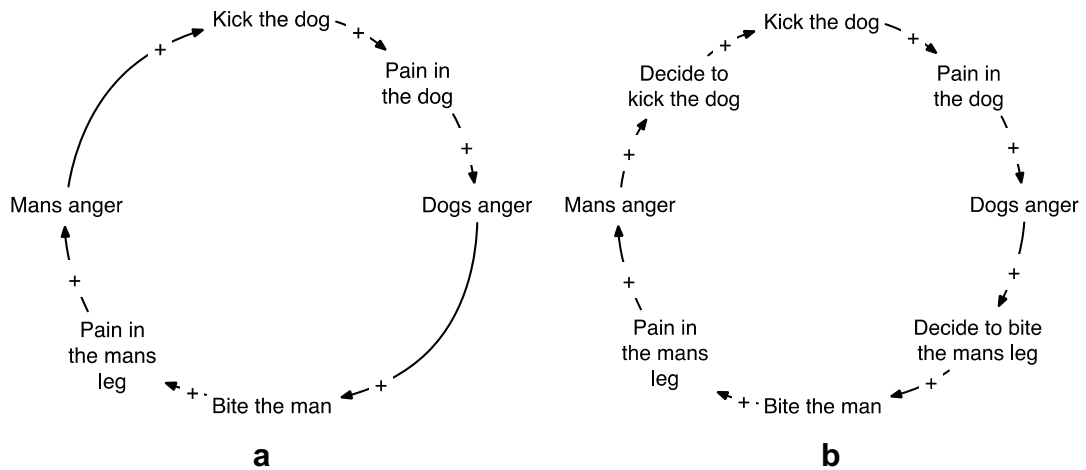

Figure 2.39. (a) The first causal loop diagram derived from the factors' causal linked table. (b) The causal loop diagram modified by introducing the decision step.

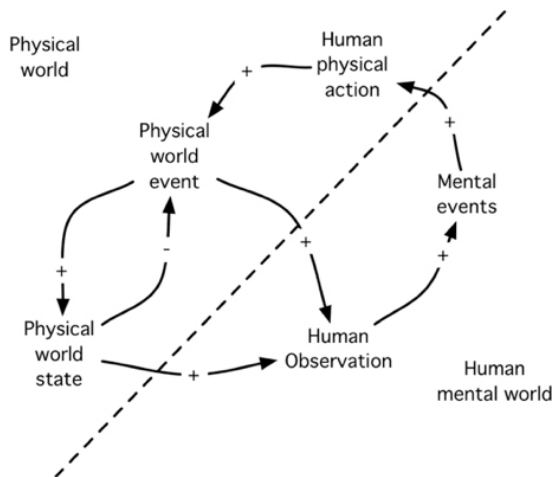

Figure 2.40. The physical world and the mental world are connected. Many things do not happen before an input, thinking about the input, and then making a decision related to the inputs.

Item (nouns)	Actions (verbs)	Controls (intensities, adjectives)	Controls (intensities, adjectives)
Man's anger	Kick dog	Prejudice against dogs	Past experiences with dogs
		Pain in the leg from dog-bite	
	Calm down	Passage of time	
	Man decides to kick the dog	Pain in the leg, previous prejudice	
	Dog decides to bite the man	Pain from being kicked	
		Logical reasoning	
Dogs anger	Bite man's leg	Pain in the dog because of being kicked	
		Prejudice in dog	Past experiences with the man

Figure 2.41. The issues were further discussed and several factors have been added.

At this point, you can ask questions. What if the man starts to logically reason about the situation? Is the dog going to get afraid at some point? That is, we need to consider the mental processes involved in decision making. Typically, focus on the physical processes, but for many situations, the mental processes can influence how actions proceed (Figure 2.43).

Figure 2.43 includes the logical thinking of the dog (as far as a dog can be logical) and the man. They both realize that if the conflict escalates, there could be serious consequences. Most animals have few or no ways to treat themselves if they sustain an internal injury or the skin is penetrated, so they avoid pain and therefore injury. As pain signals damage is in progress, the dog must “decide” whether to fight or run (i.e., fight or flight). These considerations can now be included in Figure 2.37 and Figure 2.41. This added information results in significantly revised causal loop diagram (Figure 2.42). The diagram is now more complicated, but these complications add to the understanding of the situation, revealing new avenues for analysis.

Finally, we can study the loops. Notice that in the central ring, there are only plusses, which implies that an increase will return around the circle as an increase. Because the system accelerates, the loop is called a reinforcing loop. It has a run-away property, either accelerated growth or accelerated crash. This we have marked with a large “R”. This notation represents an interaction where the fight between the man and the dog will continue until one of the combatants dies. The logic loops on each side return an increase as a decrease. This we call a balancing loop, which is marked with a “B” (Figure 2.43).

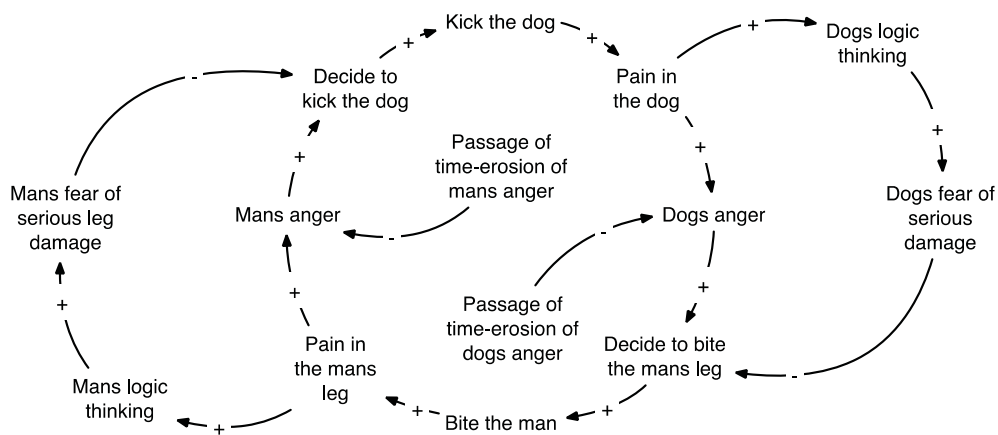

Figure 2.42. The new causal loop diagram for the man and the dog problem after a re-thinking the issues and processes operating in the system.

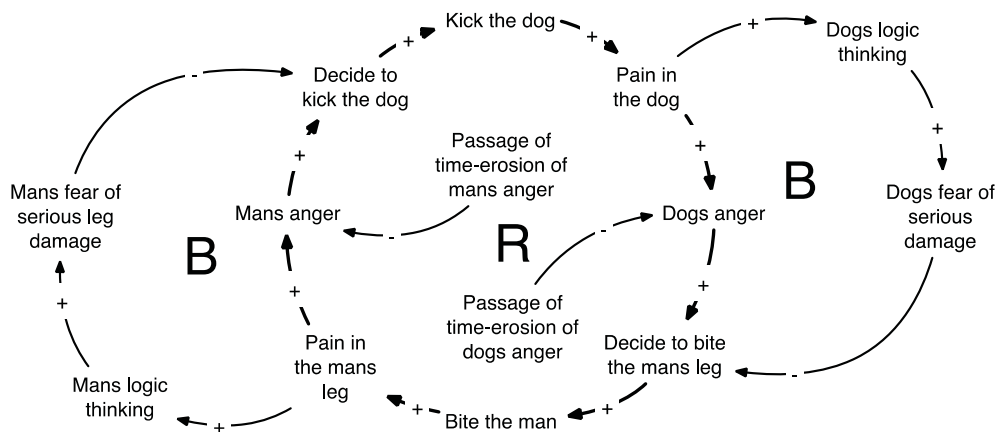

Figure 2.43. The dog-man conflict system mapped as a causal loop diagram and with the reinforcing loops (R) and balancing loops (B).

2.6.4 Formulating goals and objectives and success

Formulating the goals and the objectives is analogous to formulating a hypothesis. According to Dörner (1996), it is better to state a specific goal than a general one. Specific goals will enable the arrangement of the information by sorting out what is important and unimportant for the CLD, revealing what elements in the system are directly linked and how to use this information. Goals are long-term outcomes, whereas objectives are specific steps that are needed to reach the final goal. Defining success is the measurable progress towards reaching the objectives and the long-term goal. It can be a numerical or a tangible result that defines success.

Every task has to have clear goals and specific objectives. Without concrete goals, there are no criteria that can be used to judge whether progress is in fact being made (Dörner, 1996). Once faced with a problem, the first task should be to state the goals and objectives. This should be one of the first steps taken in the problem analysis because it is not directly obvious in

every situation what we need to do, so early formulation of the objectives minimises the time needed to gather information for the analysis. Goals and objectives should be treated like they are the questions that a problem suggests. As discussed earlier, each CLD should have its own question. When making the first analysis of a problem (e.g., deciding how the system boundaries should be stated), first consider the goals and how it is achievable with specific objectives.

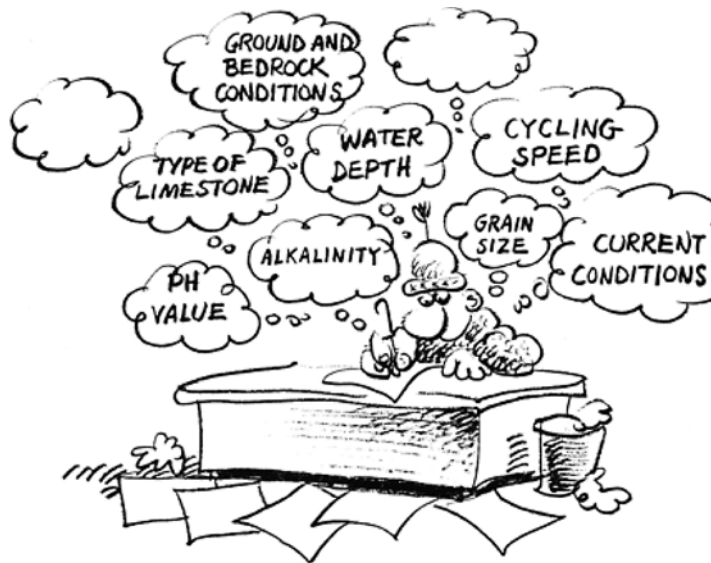

Figure 2.44. The typical devoted bachelor-modeller, working away at his thesis on lake liming in Sweden. It took many systems analysis to convert lake liming from a handcraft to an engineered and knowledge-based activity.

According to Dörner (1996), there are two types of goals, positive goals and negative goals. A positive goal works toward a desirable condition – e.g., We want fish harvesting to reach 1,143 tons this year. An objective refers to how the goal will be achieved – e.g., We will select three fishing vessels and crew for the task. Therefore, success is defined as the obtaining the measurable quantity identified in the goal: e.g., We delivered 1,143 tons of fish to Aberdeen harbour. It is important to define success since it is the practical approach to measure progress of the project. A negative goal is desiring a certain condition not to exist or the intention to avoid something. Using the logical operator “not” (i.e., negation) makes formulating goals difficult if not impossible. We do not talk of a “non-car” or a “non-house” since these categories include everything in the universe but cars and houses, an unmanageably large category, whereas “car” or “house” are much more limited categories and therefore more accessible. Similarly, statements such as ‘things have to change’ and ‘the present situation is intolerable’ are unspecified, vague goals. Determining the complexity of the CLD model requires formulating clear, specific goals. Clear goals result in clear objectives that can be used to interrogate the CLD. First, specify one main goal; then, define several objectives or partial goals for the CLD. It is also possible to define several goals at the

same time, which is often the case for complex systems. However, one principle should be considered: Contradictory goals are the rule, not exception.

For example, lowering unemployment and reducing inflation as well as minimising investment costs and increasing profits are often thought of as contradictory goals. When contradictory goals are known, then problems can be avoided; however, when contradictory goals are unknown, which is true in most cases, reaching the original goal will be difficult if not impossible. Therefore, the analysis should anticipate contradictory goals. When revising a CLD, the original goal should be scrutinised for how it affects the specific objectives, which will be easier if the goals are concrete. Use the following steps to formulate goals (adapted from Dörner, 1996):

1. State a specific main goal for the study and develop a hypothesis;
2. Formulate specific objectives that will enable accomplishing the main goal;
3. Define what constitutes as measurable success;
4. Use goals that have a positive approach to the problem; and
5. Document statements and verify them with the CLD.

All modelling work, including CLD modelling, makes predictions and assessments using either forecasting or backcasting or both. Forecasting describes or estimates probable future conditions and trends. For example, forecasting can be used to identify future resource shortages or how to design policies. Forecasting focuses on three questions: What can happen? What ought to happen? and What is likely to happen? Backcasting, on the other hand, describes or estimates a desirable future that is attainable, not probable. Backcasting makes it possible to determine what actions are required to achieve a desired future. Backcasting, as the name implies, works backwards from a desired future point to check the feasibility of achieving the desired future (Mitchell, 1997). That is, backcasting identifies the consequences of choices taken, whereas forecasting identifies consequences of choices to be taken.

This brings us to the discussion of indicators and how they can be defined. By defining goals, objectives, and success, we already have taken the first steps to associate measurables to the project. We have connected the desired long-term state, what steps are needed to bridge the gap, and how we measure progress – i.e., successfully achieving the goal. This connection also helps us select the key indicators essential for understanding and communicating the project.

2.6.5 Summarising mental modelling

When constructing a model, the following guidelines should be followed. The first step is the development of the mental model. The second step is the dynamic simulation of the mental model using computer programs such as Stella, Powersim, Imodeler, and Vensim. The following steps are involved in developing a mental model (CLD):

1. Define the problem by establishing the system boundaries.
2. Ask the question and explicitly state the purpose.
3. Define the goals and define the success.
4. Sort main variables in the problem and list them in hierarchal order.
5. Draw a causal loop diagram (CLD).
6. Test CLD understanding with peers.
7. Draw Reference behaviour pattern (RBP) and Observed behaviour pattern (OBP).
8. Learn and revise.
9. Conclude.

Transferring the CLD into a computer model involves the following steps:

1. Identify the stocks and flows and draw the outline of the model and possible sub-models.
2. Identify items, actions, and controls.
3. Identify core variables. Be sure you understand what you are doing.
4. Keep track of the units in the model; do not mix parameters.
5. Test model with conceptual figures against extremes in the model.
Do the “reflection stress test”: Does the model reflect the CLD?
6. Design and test different policies or use the “what if” method.

Although system thinking looks promising in theory, it is easy to misinterpret the concept if the methodology is incorrectly used. Several researchers (Roberts et al., 1983; Sterman, 2000) have expressed that it is important identify the possible failures in reasoning when constructing scientific arguments.

Three main indicators describe how the scientific methodology of system analysis can be successful. First, complex problems require deep knowledge of the underlying causes and therefore the problem cannot be solved solely using analytical techniques. Second, to determine how to draw system boundaries, the researcher needs to be skilled in organising and structuring. Third, the researcher has to follow important causal behaviours during the analysis.

The success of the methodology comes with the ability to work in a trans-disciplinary milieu. The best results are obtained in group work in the initial phases of the problem formulation and the structuring of the analysis, as this makes testing the logic of the model possible. It is important to understand that the Systems thinking is a communication tool that bridges disciplines by creating shared insights and questions that may lie outside one’s expertise.

Unfortunately, the conventional educational system rigidly separates disciplines. Systems thinking acknowledges that science is an activity of approximation as causal behaviour can never be 100% determined, only approximated. This insight gives us the possibilities to make generalisations in research that can be critically evaluated and moved across disciplines, a strategy that is needed for addressing society's complicated problems.

2.7 Exercises: Practising CLD and RBP

Step 1. Solve a single simple task

Now it is time to construct your first causal loop diagram and flow chart. Practice these until you are comfortable with the process.

2.7.1 The running girl

Look at the picture below. Jane is a professional runner and is just about to start a marathon through the desert. The day is expected to be hot and sunny. Jane is visualising how she will complete the run and mentally preparing for all the milestones along the way. All her gear (water bottles, clothes, shoes, etc.) is prepared. During the run, the combination of heat and sun causes her to sweat a lot to keep cool.

From this narrative, we can frame (i.e., draw boundaries) around why (i.e., competing in a marathon) and where Jane is running (i.e., a desert). To begin, ask questions to ascertain the space and time conditions – i.e., how far and how long she will run. Asking such questions helps sort out what belongs in the causal loop diagram. Analyse the situation further, looking for related variables that are not evident although clearly part of her run. Furthermore, ask questions that define what constitutes success (e.g., completing the marathon). These questions will help uncover what items (i.e., variables) affect whether Jane will complete the marathon.



Figure 2.45. Jane decided to participate in the Nevada Desert Marathon. It will take place on an especially hot summer day so she will be sweating a lot.

Now, find a partner to work with on this problem together. As a pair, follow the steps outlined: write a mission statement, form a conceptualisation, create CLDs, and create flow charts. Remember, for each item (noun), prepare a separate flow chart. Where does the item come from, where does it remain, how is the stock emptied? Use Table 2.2 as support.

1. Define the problem. Doodle \ pictures or a small cartoon if it is difficult to get started.
2. Define the problem's boundaries (i.e., its frame).
3. Make a very clear question for the problem.
4. Brainstorm a list of the relevant variables but avoid sorting.
5. Sort the variables according to importance (i.e., remove unnecessary details).
6. Start simple and build up the causal loop diagram slowly.
7. Estimate the behaviour of the problem using Reference behaviour pattern (RBP).
8. Ask these questions: What behaviour can be read from the CLD and flow charts? How does this behaviour compare to the Observed behaviour pattern (OBP)? That is, what similar historical situation would the behaviour predict? Use nouns, verbs, and adjectives when answering these questions.

Table 2.2. Basic CLD preparation table.

Basic CLD preparation table			
Items handled	Actions occurring	Controls of actions	Further controls

Step 2. Simple pieces to practice on

Before continuing, work out these simple examples. Read the tasks and create simple CLD, flow charts, and RBP diagrams. Before drawing an RBP, use OBP to place events on the graphs – i.e., what you think will happen at a certain time. In addition, plot the RBP of the actors on a single diagram to observe the dynamics. Define each problem using the guidelines for how to state goals and create questions. Allocate at least 30 minutes for each task.

In a 2–3 person group, define the system boundaries and ask the questions before developing the CLD. Make sure the flow charts are 100% consistent with the CLD. Allow enough time to refine and redefine several iterations of the CLD, a process that should take several hours.

2.7.2 The urbanisation of south Fantasia

Fantasia is an island in the South Atlantic Ocean. The islanders have been experiencing high economic growth in recent years. Urban development has especially increased in south Fantasia where harbour conditions are excellent. The only drawback with this location is the limited land space available for development of industry and new housing, a condition that could increase prices and make the area economically unattractive. Create a CLD, flow charts, and a Reference behaviour pattern diagram that describes the interaction between economic development, urbanisation, and land availability. Draw the RBP for urbanisation.



Figure 2.46. The city of Fantasia has beautiful beaches and untapped economic opportunities.

2.7.3 The hydro dam in Mos Eisley

After a lengthy debate on environmental effects of hydropower, the inhabitants of Mos Eisley have built their first dam in the nearby mountains. The dam is in a narrow valley with a fairly large river flowing through it. The technicians are filling the reservoir behind the dam for the first time to test the outlet valves and the flow dynamics of the dam. To test the flow dynamics, they need an expert to describe the dynamics of the inflow and outflow and the interaction with the water inside the reservoir. Create a CLD, flow charts, and RBP for the water level of the full reservoir; the river never runs totally dry and the electricity production runs at full capacity. Mos Eisley is in the desert and the power plant is located in the mountains 65 km to the east (Figure 2.47). The management of water is important.



Figure 2.47. The dam is a beautiful engineering work, made to last over 100 years.

2.7.4 Mining minerals in Antarctic

Antarctic Mining Corporation Inc. (AMC) has bought the mining rights to a large parcel of land near the Queen Maud Land in Antarctica. Mining in a polar region requires using new methods, but the minerals are only partially available as a thick glacier covers the continent. Since so little is known about the geology of the Antarctica, AMC has undertaken basic mineral exploration. It is suspected that the most accessible minerals will be exploited first and

mineral exploration will be needed to locate further resources (Figure 2.48). Create a CLD, flow charts, and RBP (for availability of minerals).



Figure 2.48. Mining operation.

2.7.5 Mars, the next frontier

In the year 2086, Mars will have its first human settlements (Figure 2.49). The settlers have brought a lot of equipment to transform the environment that will in the distant future change the Martian surface to become more like Earth. They also will bring a limited amount of resources and energy needed until they can live off Martian resources. The process of creating an atmosphere and cultivatable land will take a long time; if successful, the colonists will eventually settle new areas and make the area usable for more people as the population increases. Create a CLD, flow charts, and RBP (population).



Figure 2.49. Jack and Jill Young enjoying their time on Mars.

2.7.6 Gaia and climate change

Gaia, an island near Tonga, is a peaceful place. The inhabitants have flourished on the island for centuries, relying on traditional farming to grow their main food source, the Slartibastfast coconut. Cultural traditions on Gaia have created a balance between the population size and the yearly crop yield. The inhabitants are pretty well off; however, climate change has created a problem. Due to the low topography, rising sea levels threaten to submerge large areas of agricultural land, limiting the resources (Figure 2.50). Create a CLD, flow charts, and RBP (resources).



Figure 2.50. Gaia.

Step 3. More complex tasks to practice on

The following problems are more complex, so they require larger groups to solve. These tasks require more work and group work. They contain several issues nested inside each other. Perform the tasks in teams of 2, 3, or 4. Uncover the tasks and draw CLD and flow charts.

2.7.7 The traffic problem in Malmö City

Malmö City has been experiencing massive traffic gridlock (traffic not moving for hours) during weekdays. The gridlock is worse when commuters are driving to and from work. The problem has always been there in some form, but it has worsened after the bridge from Malmö to Denmark was completed. Real estate prices are cheaper in Sweden, so some Danes live in Sweden and commute to Copenhagen for work. The traffic jam is becoming part of the commuter's everyday life. What used to take 30 minutes, now is a major undertaking. When the first signs of traffic problem arose, the city enlarged existing roads (more lanes – e.g., single lane roads were expanded into double roads) and built more highways. This strategy has worked in the past, but now it seems there are just too many cars (Figure 2.51).

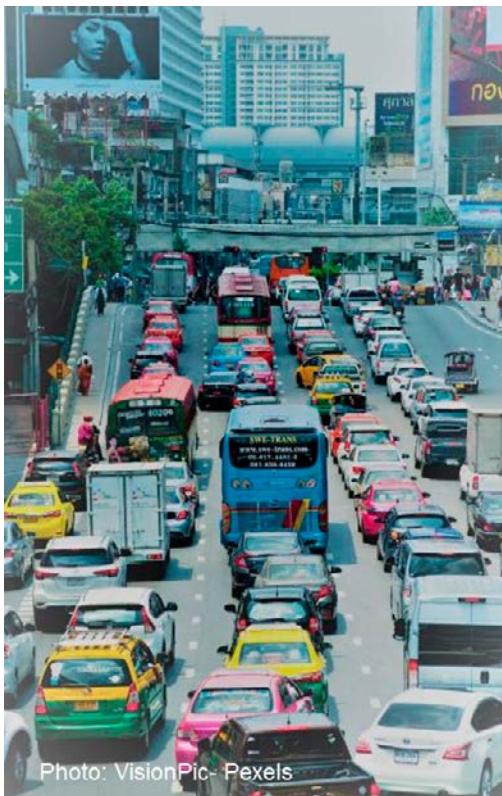

Figure 2.51. When many cars use the same roads, it is difficult to get home.

In addition, more traffic means more air and noise pollution. People are not happy and many are starting to move to other communities around Malmö. One unhappy inhabitant described the situation like this: ‘It’s better to take an extra hour to work every day than listen to the highway around the clock’. This outmigration results in the loss of tax revenue for the city. Although public transport is in place, it has not been prioritised. Bus tickets are expensive, busses are often late, and there are too few bus routes. Many people just consider it more profitable to use their car as driving takes about the same time to commute and costs about the same as public transport. One person describes the issue like this: ‘I have to take three buses just to get to work; I would rather sit in my car instead’. Politicians in Malmö are desperate and need assistance with this problem. They are not sure if there is one cause or many causes. They are asking you to help them define the problem and confine the core issue within the problem. You have been charged to find one or several long-term scenarios that make the city attractive enough that people will want to live in the city.

You are a consultant and have been assigned to the city’s expert team. Identify the main issues and what the root cause(s) are, how extensive the problem is, and what the city should do to improve the situation.

Present your analysis using a CLD, flow charts, and an RBP/OBP that can be used to explain to the city council how the problem has evolved and how the problem should be solved, both in the short-term and long-term.

2.7.8 The polluted lake in Duncan

Duncan is a city in the mountains in the north where people enjoy many outdoor sports such as hiking, hunting, and fishing. Duncan is located by Lake Tranquillity, which is famous for its big salmon, which every year migrate from the ocean up Tranquillity River and into Lake Tranquillity. The combination of natural landscape and salmon fishing makes Duncan a tourist attraction. Tourists enjoy fishing and the tourism is flourishing and is becoming an important part of the area's economy. For many years, the chemical manufacturer ZorChem has provided work for the inhabitants of Duncan. Due to ZorChem, Duncan has risen from being a small village to a vibrant city. More than half of Duncan's inhabitants work at ZorChem. For 20 years, ZorChem has dumped its waste chemicals directly into Lake Tranquillity (Figure 2.52). Recently, the inhabitants have started to experience health problems related to consuming fish caught in the lake. This has also started to affect the salmon tourism.

An environmental representative working on the city council has determined that the fish contain mercury levels 100 times higher than the normal background level in nature. He has confronted the board at ZorChem, who are reluctant to take actions. Many inhabitants of Duncan are protesting the company's actions. Closing down the plant is not feasible, according to some, since most of the Duncan's residents work at ZorChem. But something must be done.



Figure 2.52. A large factory polluting Lake Tranquillity.

You have been given the task to assist the community council on defining the problem, explaining to the city council how the problem has evolved. Is it possible to keep the factory and preserve nature or does the community have to choose one over the other? Your task is to present your analysis by constructing a CLD, flow charts, and an RBP/OBP. Create alternative scenarios that describe how the problem should be solved, both in the short-term and long-term using CLD, flow charts, and RBP/OBP.

2.7.9 Three Gorges Dam

The building of Three Gorges Dam on the Yangtze River in China is one of the most controversial projects of the last decades. You can learn more about it in Wikipedia². In 2003, the first stage of the building project was completed. However, while many view this event as a success, other groups are sceptical and this scepticism is increasing. Three Gorges Dam was initially conceived in 1919 by Sun Yat-Sen, one of the most prominent revolutionary political figures of early 20th century China and considered the father of modern China. Sun wanted to construct the dam for power generation, but his idea was discarded due to adverse economic conditions in China at the time. In 1979, however, the Three Gorges Dam was again on the government's agenda, as the need for electricity was growing. The project received serious criticism both from within China and internationally. Yet, the serious concerns did not deter work on the Three Gorges Dam, which finally started in 1994. Due to its size and the technical difficulties related to its building, the budget for the dam was officially set to 25 billion USD. Supporters of the project maintain that the electricity generated will pay for the project. Opponents of the dam estimate that the cost has already reached 75 billion USD due to technical problems and corruption.

The opposition also claims that the high cost of the Three Gorges Dam limits investment in other urgent areas. Supporters, however, emphasise the importance of the Three Gorges Dam in controlling flooding, which has caused severe damage and limited the development of the regions downstream. Electricity generated by the dam will reduce the need for coal and nuclear power and therefore will help limit emissions and hazardous wastes. Opponents, however, argue that the Three Gorges Dam will encourage the development of industries along the water, increasing the risk of water pollution, will result in flooding upstream of the project, endangering many fish species, and will require extensive logging upstream, further impacting the environment. In addition, the Three Gorges Dam is also expected to increase coastal erosion in the river delta since it will keep the silt from reaching the coast. Accumulated silt behind the dam is also expected to affect how well the Three Gorges Dam will limit flooding in the future.

² https://en.wikipedia.org/wiki/Three_Gorges_Dam



Photo: Peggy and Marco Lachmann-Anke- Pixabay

Figure 2.53. The Three Gorges Dam, a huge hydropower plant in China, is an important alternative to coal-fired power plants, the main source of electricity in China and a significant contributor to air pollution.

Another impact of the Three Gorges Dam project is human resettlement. Supporters claim that the dam would provide a safer environment downstream and therefore promote more opportunities for future urban and agricultural development. In addition, the government assured proper compensation for the resettled people, and that the improved conditions downstream will provide more job opportunities. Opponents, however, maintain that the resettled rural populations are established on poor lands and that funds intended to teach them new job skills have been diverted by corrupt officials.

In 2010, the Three Gorges Dam project was completed. Many historical monuments have been moved to protect them from the flooding caused upstream. The power plant produces large quantities of electricity and has been important for securing China's power supply to fast growing industries. It has been an important alternative to using coal power plants. Despite this, many people are upset by the disappearance of the river scenery and the culture and traditions related to the region.

Your task

Evaluate the advantages and disadvantages of the Three Gorges Dam: the short- and long-term gains and losses related to the dam.

Define the focus and boundaries of the system: where and what to study and when to study?

Think through the variables you need to include in drawbacks and benefits from the Three Gorges Dam.

Connect the components of the problem in a CLD and create the flow charts for all important variables involved in the project.

Run future scenarios.

What would happen if the price for oil increases?

What would happen under different climate change scenarios?

Could new technologies provide cheap and clean energy in the future.

Can you use your CLD and flow charts to predict the effect of such developments of the Three Gorges Dam system? Show, for example, the reference behaviour pattern of a representative variable.

Determine whether the project been successful (Internet research).

3 The System dynamics modelling process

3.1 Understanding

In System dynamics, the system understanding gained from Systems analysis is used to recreate representations of what is understood and to check whether this understanding can reproduce the outputs observed or created for the future. Delays are also discussed in the literature (Ford, 1999a; Maani and Cavana, 2000, 2007; Sterman, 2000). All systems have some kind of delay, which can range from seconds to days, centuries to millions of years. Delays cause systems to fluctuate. A delay occurs when an action between two components in a system is slower than the rest of the system. A system consists of many feedback loops in which some loops reinforce certain behaviours (i.e., a positive feedback loop), indicated with a “R”, and some loops dampen certain behaviours (i.e., a negative feedback loop), indicated with “B”. The interaction between positive and negative feedbacks produce oscillations whenever the causality is delayed in one or more steps. The non-linear relationship between the variables in combination with feedback loops will result in non-linear behaviours that require numerical models for understanding. Non-linear behaviour of the system feedback loops can shift dominance during the observation period (Ford, 1999b). Delays are conceptually hard to predict since they are not always manifested in current behaviours. By learning the history of the system and observing the scaling of the variables (i.e., where in the system level hierarchy and temporal scale are placed), it is possible to estimate the pace of the ‘action’ among variables. A system that crosses different system levels and includes a long time frame will have delays.

Typically, the longer the delay, the larger the oscillation. This correlation may pose some difficulties when analysing a problem as feedbacks with long delays risk going unnoticed. Therefore, the steps that precede any analysis of a system require understanding the properties of the problem and how the symptoms are manifested. Delays in a system are created in three ways:

1. Buffering mechanisms such as stocks (fluxes) that take time to be filled or emptied.
2. Kinetic limitations where a process may proceed at a limited rate of reaction progress or rate limitation in a transformation process. In transportation, this is called a bottleneck.
3. Transmission delays where there may be low velocity transitions within the system such as in maritime transportation.

Even if conditions allow for equilibrium, the implementation the actions that will result in equilibrium will not be instant. Delays cause oscillations in a system any time feedback is present (Prigogine, 1980). If several delays are present in dependent systems with feedbacks, the oscillations may become

very complex; despite underlying order, the integrated system's output behaviour may appear chaotic (Prigogine and Stengers, 1985; Wolfram, 2002). Buffering delays, kinetic delays, and transmission delays commonly occur in earth systems (Ammerman and Cavalli-Sforza, 1972; den Elzen, 1994; White and Brantley, 1995; Lasaga, 1997).

3.2 The System dynamics modelling process

As 'All models are wrong but some are useful' (Box, 1979), a successful modelling process for any problem requires some humility. The System dynamics community has proposed several ways to conduct system dynamics modelling. Forrester (1961), who provides a guide for building a system dynamics model, concludes that people tend to use statistical procedures in search of scientific 'objectivity' in the modelling process. Therefore, he suggests modelers should start by defining the question and scope of their problem and formulate a hypothesis before any numerical analysis, a view that prevails in most system dynamics research. Randers (1980) divides the modelling process into four parts: conceptualisation, formulation, testing, and implementation. Randers speaks of two phases: a conceptual phase, where CLDs are used to formulate a hypothesis, and an equation phase, where computer models are constructed from the results from the conceptual phase. Richardson and Pugh (1981), Roberts et al. (1983), Wolstenholme and Coyle (1983), Wolstenholme (1990), Maani and Cavana (2000), and Sterman (2000) have developed further steps for the mental modelling procedure, which is summarised by Luna-Reyes and Andersen (2003) (Table 3.1). No single approach has been preferred although Vennix (1996) advocates for Richardson and Pugh's (1981) procedure. However, most researchers agree that developing conceptual models is important. Actually, Luna-Reyes and Andersen (2003) recommend modellers take courses in collecting and analysing qualitative data. Wolstenholme (1999) introduces the concept Intertwined project learning (IPL) as an attempt to fully integrate the qualitative and quantitative aspects in System dynamics, as he believes neither qualitative nor quantitative approaches can achieve their full potential in isolation.

Table 3.1. The System dynamics modelling process adapted from Luna-Reyes and Andersen (2003).

Randers (1980)	Richardson and Pugh (1980)	Roberts et al. (1983)	Wolstenholme (1990)	Sterman (2000)
Conceptualisation	Problem definition	Problem definition	Diagram construction and analysis	Problem articulation
	System conceptualisation	System conceptualisation		Dynamic hypothesis
Formulation	Model formulation	Model representation	Simulation phase (stage 1)	Formulation
Testing	Analysis on model behaviour	Model behaviour		Simulation phase (stage 2)
	Model evaluation	Model evaluation	Policy formulation and evaluation	
Implementation	Policy analysis	Policy analysis and model use	Simulation phase (stage 2)	Policy formulation and evaluation
	Model use			

Similarly, some researchers have combined Checkland’s Soft system methodology (SSM) with System dynamics group model building (Vennix, 1996; 1999). For example, Rodriguez-Ulloa and Paucar-Caceres (2004) have developed a ten-step procedure called Soft system dynamics methodology (SSDM) that merges concepts from both fields. This variety of adaptations of the modelling processes demonstrates the flexibility allowed in the process as long as a conceptual model is always present.

3.3 Reworking the modelling procedure

CLD have been used in the System dynamics modelling to map causalities and identify the properties of feedback loops. Although qualitative System dynamics tools such as stock and flow diagrams (see section 3.2) are used as well, there are some differences between the two CLDs and SFDs. According to Wolstenholme (1999), the advantages of using CLD over SFD is that stock and flows (e.g., rate of flows) require additional skills to understand; however, it is not entirely clear that Wolstenholme is referring to a standard stock and flow diagrams or a particular System dynamics tool diagram (SDTD). This discrepancy in terminology is discussed in section 3.2.

<p>Abbreviations CLD = Causal loop diagram SFD = Stock and flow diagram SDTD = System Dynamics Tool Diagrams FD = Flow diagram</p>
--

This chapter advocates using the approach initially defined by Randers (1980) – i.e., distinguish the qualitative conceptual phase from the quantitative equation phase. The ability to ask the right questions depends on the ability to put together a group of people with the sufficient background knowledge to correctly define the problem. A CLD reflects an understanding of the problem,

so the definition and the questions asked of the problem are reflected in the CLD. This process is done through group model building, as advocated by Vennix (1996; 1999). Inevitably, group members will have differing mental models of any problem being considered, resulting in miscommunication when the group tests these models. However, this is expected and perhaps even necessary as group model building brings together different mental models to find a common denominator that can help the members understand one another's mental models (Vennix et al., 1996). Group model building should create a shared mental model. This process starts by framing a question for the problem. The question takes the form of a hypothesis that is falsifiable, a major tenant of scientific investigations, either through verification or refutation through several iterations as a continuous learning process called the Learning loop (Figure 3.7).

As discussed in section 2.2, this study assumes that all modelling starts as a theoretical model where a hypothesis is developed in the conceptual phase through questions, and conceptual diagrams (e.g., CLD and SFD) are developed as mental models and numerical models are developed in a continuation of the theoretical model in a SDTD (see section 3.2). CLD analysis is powerful enough to operationalise critical thinking into manageable concepts that can be included in policies (Cavana and Mares, 2004). Therefore, start with a conceptual analysis of a CLD supported by the traditional engineering terminology of SFD as developed by Walker et al. (1923). A SFD used as a flow chart will enhance the CLD by showing flow dependencies. The SFD, developed by early engineers, attempts to capture the mental model of the system, but its causality content is far lower than the causality content of a CLD. This deficiency is dealt with by documenting the equation system associated with the SFD, which explains the causality. In reality, CLD is a graphical representation of coupled differential equations. The CLD and the SFD in combination is presented here as the preferred method for displaying the mental model. The proposed steps for the modelling process are presented below.

3.3.1 Define the problem and create system boundaries

Analyse the symptoms and how they manifest in the problems by asking questions such as “What are the symptoms?”, “What are the causalities?”, and “Is it possible to map any hidden structure?”.

Ask general questions about symptoms to establish an overview of the scales and dimensions of the problem. Define the system boundaries according to the understanding of the problem the group (or individual) define. Because the system boundaries will change during revisions, the boundaries need not be anchored completely. Consider the delays in the problem and how they manifest. Because the symptoms only show partial structure of the total problem, it is necessary to ask many questions related to the symptoms of the problem. These sorts of question make it easier to analyse the symptoms and rank their importance. To reveal the underlying structure, specialists or experts might need to be invited to join the process, filling in the gaps of

knowledge the group lacks. The stakeholders tell their story: how they contribute to the symptoms or how the symptoms contribute to their behaviour. This process is shown in Figure 3.1.

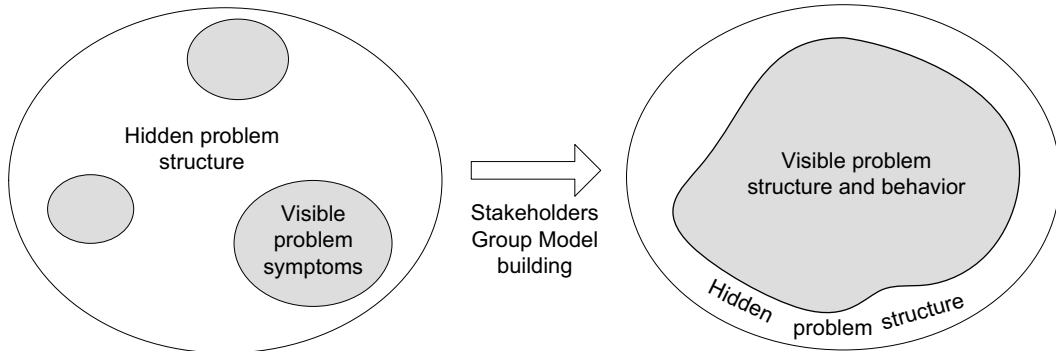

Figure 3.1. How the stakeholders clarify symptoms and the underlying structure of the problem.

Approximation implies describing the problem sufficiently to answer the questions posed regarding the problem. Other aspects related to the problem are put into assumptions that are not considered important and therefore inconsequential to the analysis. During this stage, it helps to use conceptual diagrams such as mind mapping, CLD, and SFD. A problem can never be ‘fully’ documented due to the interconnectivity and levels of details and complexity, but its understanding can be approximated.

3.3.2 Ask the question

Ask the question – that is, explicitly state the goals and objectives of the modelling exercise. During this step, the dynamic hypothesis is developed. The dynamic hypothesis requires a specific question, so ask specific questions that will clearly define what is to be understood and what is to be answered. The number of questions should be sufficient to address dimensions such as the system’s scale and time, the range of scales to be considered (highest to lowest), etc. It is possible to have many questions to one problem, but generally it is best to have one question per mental model (i.e., per CLD and SFD). Understand the focus of the questions. For example, consider the following questions from a case study regarding local groundwater use in southern Sweden.

- Q1. What role does the local aquifer have for the regional water security?
- Q2. What are the benefits of the water quality from the aquifer for the local municipality?
- Q3. What are the impacts of urban encroachment on the aquifer?

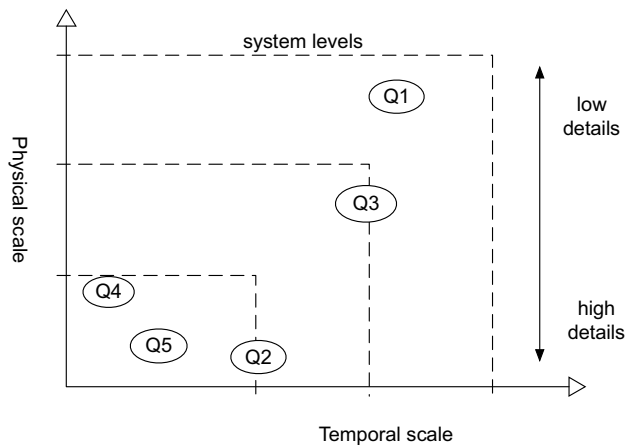

Figure 3.2. All questions are within the same domain of the problem, but they might have a different focus.

All questions are about the groundwater, but their focus might be completely different. Q1 considers the aquifer in relation to its surroundings – i.e., how it is connected in the web of water extraction and water use within the municipality. Water is only one aspect of many considerations related to the aquifer. Q2 is a narrow focus on a specific aspect of the aquifer and its quality relative to other water sources. Q3 focuses on the area around the water rather than the water itself. Because all the questions reside within the same domain of the aquifer case (Figure 3.2), the focus must be on the issue that is most important for the understanding of the problem according to the needs of the group. If other issues than water are discovered that may alter some definitions of the problem, the focus can be adjusted. This process can either redefine the system boundaries or shrink/enlarge them.

The starting phase- working out the relevant questions

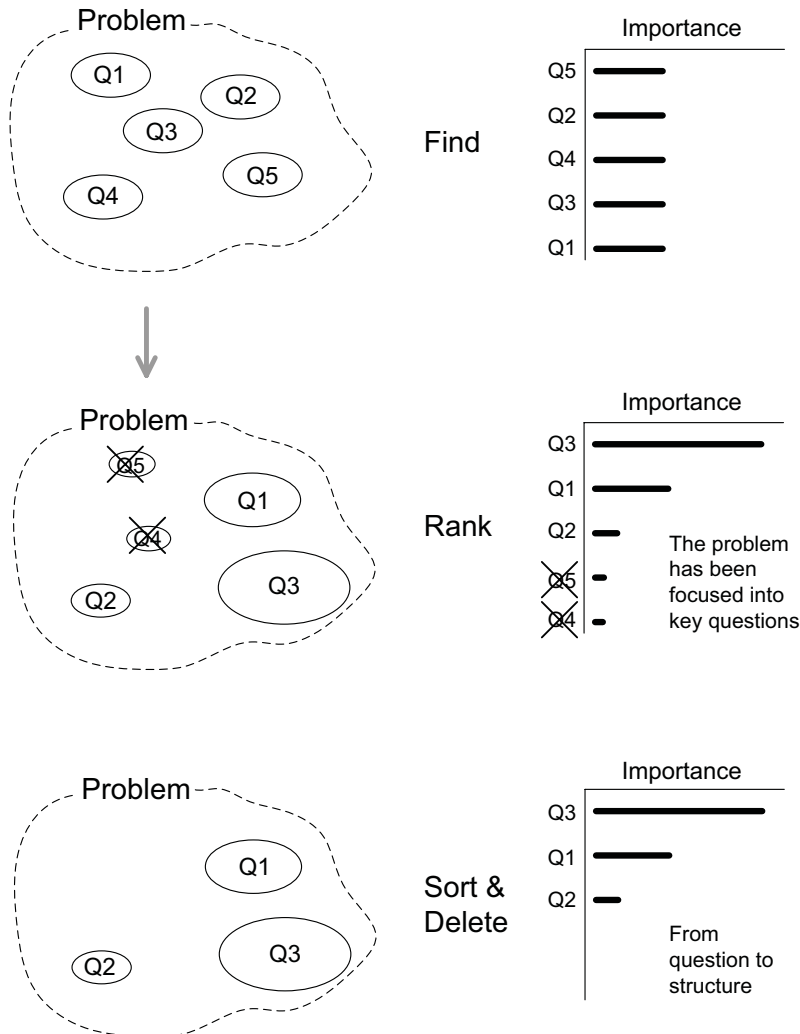

Figure 3.3. The process starts by formulating the questions and ranking the key questions before finally going from question to structure by identifying the variables for the important questions. This is done after the questions have been evaluated through the sorting and deleting phase.

3.3.3 Sort the main actors

After formulating the questions, they are ranked and variables are sorted in the phase that transitions from question to structure (Figure 3.3). Create a list of variables related to the question and sort them according to importance; list the most important variable for the question first, the second most important variable next, and so on (Figure 3.3). It is better to first create a long list of variables that are considered important for the question and then delete the unnecessary ones. However, it seems best to start with no more than ten variables when going to the next stage of creating a CLD, although the other variables may be used later to address other questions. In the case of the aquifer, after ranking the questions, it was found that addressing Q3 was the highest priority since it was vital for the future of the aquifer. Q1 had second priority and Q2 third priority. In this way, all the variables of the

high-priority questions and the system boundaries accompanying them could be mapped. This sorting process in the modelling procedure becomes one of the turning points in the process since it is here that the different questions and variables are identified and used.

3.3.4 Start a CLD and/or SFD model

Draw the CLD and then draw the SFD to show flow dependencies and fluxes (or draw the SFD and then the CLD, whatever fits the purpose). When the variables have been listed, look for cause and effect between the variables. Draw causal links between variables and ask if there is a link back (feedback loop). If necessary, create several clusters of loops and connect them at a later stage as shown in Figure 3.3. Structuring a CLD in a disciplined manner also reveals loop trends. Avoid cluttering the diagrams with lines. Half the understanding is understanding what the diagrams represent, so make the loops visible, easily identifiable. It helps to make loops in a structured manner when doing a feedback loop analysis. Feedback loop analysis helps structure the problem and uncover trends within the system (Ford, 1999b; Wallman et al., 2004). Furthermore, feedback loop analysis can help determine if the overall structure is behaving according to some archetypical behaviour. When describing a complex diagram, it is better to use several smaller CLDs and show where they are connected (the term ‘ghost’ is often used, for example, to show a ‘shadow’ of a variable at more than one place in the diagram although it is the same variable). State the assumptions and limitations in the study so it is clear what is included and what is excluded. The SFD should be used to support the translation from the CLD to SDTD as this helps when creating a numerical model. As drawing a CLD is an iterative process, expect and welcome changes.

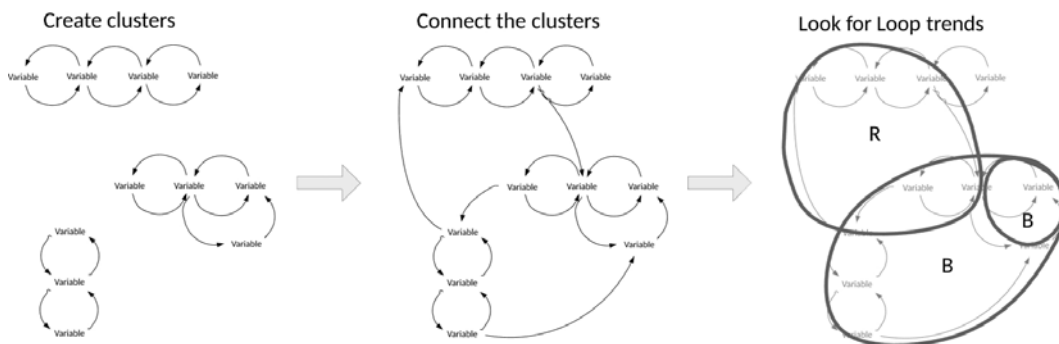

Figure 3.4. Create clusters of CLD and connect them. Look for loop trends.

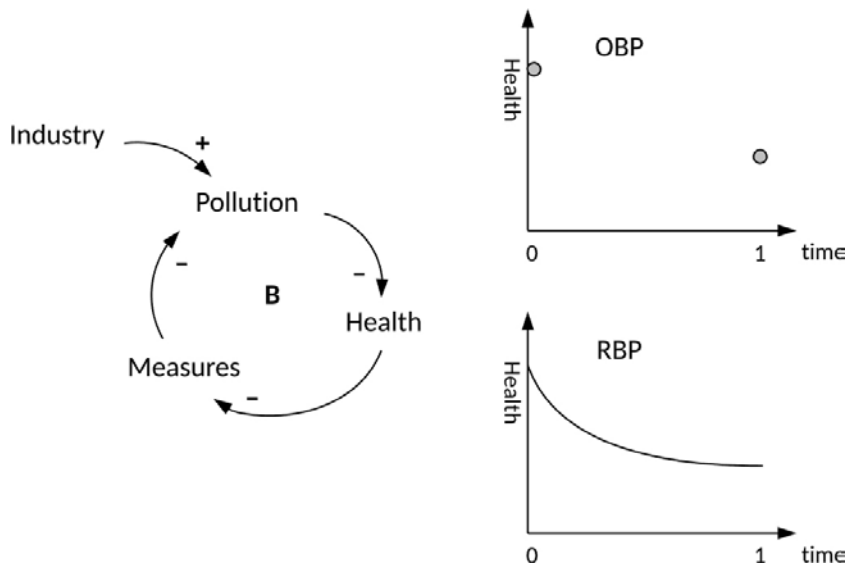

Figure 3.5. RBP and OBP help explain the loop.

3.3.5 Create an RBP and OBP

Use a Reference behaviour pattern (RBP) to explain the behaviour in the model. A RBP is a display of change in the behaviour of a variable. Draw only the RBP that explains the feedback behaviour. Compare the RBP with an Observed reference pattern (OBP). Is there a difference? This step is presented in Figure 3.5. Observe if any of the loops represent an archetypical behaviour.

3.3.6 Test the CLD and the SFD model

After the first version of the CLD and SFD is completed, check if the assumptions are reasonable using the “reflection stress test”. The “reflection stress test” tests initial assumptions. Does the model produce results that are far from what you consider reasonable? Are the results outright silly? This has much relevance for both soft and hard variables. For example, when doing numerical simulations, if your model says the river runs uphill, it fails the Norwegian laughing test. If your intelligent guess was that your dog weighs 4 kg but your model result is 300 kg, then you know it is outside the limits of reasonable result, so it also fails the Norwegian laughing test. If you find yourself laughing at the assumptions, then clearly something is wrong with the CLD and SFD, and indeed the assumptions fail the Norwegian laughing test. Look for advice from colleagues and request feedback on the CLD and SFD and test the understanding on other people and use literature and data. Make use of the Reference behaviour pattern to explain how the variables behave in the model.

3.3.7 Learn and revise

The combination of CLD and SFD is never right the first time; it is improved through an iterative process. The discussions around this process create new insights and new questions. Often, the group revises the structure to reflect the new understanding. The performance of the proposed CLD and SFD combination is tested and checked. The performance is considered to be placed according to the number of components, as was discussed in section 2.5 and seen again in Figure 3.6. The purpose of mental modelling is to understand and explain the problem with the highest performance in relation to the number of components. The revision and the iteration process aims at reinforcing this purpose. Therefore, it is natural to start with a very simple CLD and SFD to ascertain a basic understanding before looking for higher complexity. However, it is important to make the CLD and SFD overly complex – i.e., to draw every thinkable cause into the model as this approach makes it possible to obtain an eagle’s perspective and simplify the model to what the group considers the optimal complexity. The process goes back and forth until the group considers it has obtained the optimal complexity. After completing this part, the group should reflect on the new understanding and make the necessary revisions by going back to step 3.

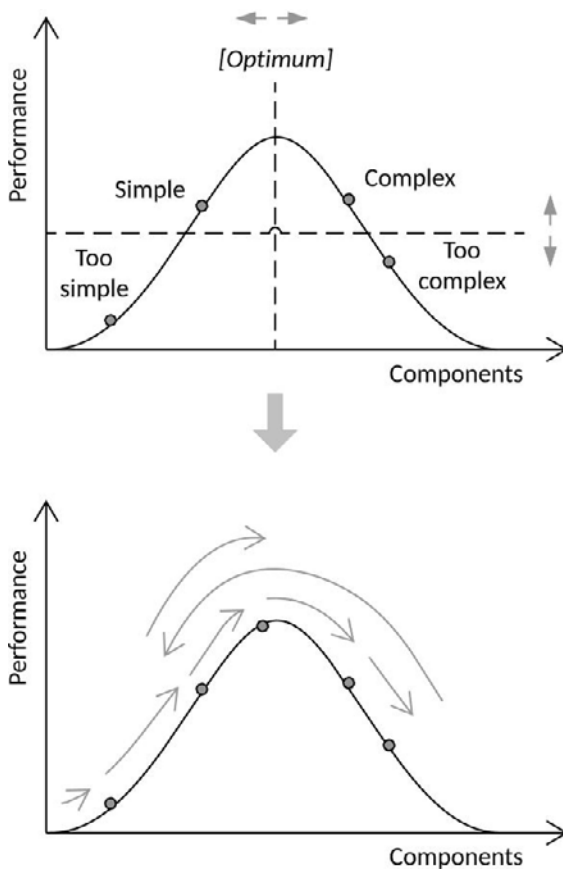

Figure 3.6. The CLD and SFD explain the problem with the highest performance in relation to the number of components. This reasoning is also applicable to SDTDs and numerical code. Iteration between the 'too simple' and 'too complex' is important for finding the optimum number of components needed to answer the question.

3.3.8 Conclude

It can take several iterations to be content with the final version of the CLD and SFD. A conclusion is only made if the initial question is answered. Observe if the conclusion actually changed the initial question, which it often does. The initial question often changes due to the iteration process in the conceptual analysis. Therefore, the definition of the problem and the focus of the question can, and perhaps should, change.

3.4 The learning process

3.4.1 The learning loop

As discussed earlier, a system boundary is related to the question that is asked of the problem. A question that has a narrow focus (i.e., one specific item in a large problem) has small system boundaries. A question that has a broader focus (i.e., several linked items) has larger system boundaries. That is, system boundaries are related to size and temporal aspects of the system. The modelling procedure works best if it is possible to test the conceptual diagram on someone who is not part of the modelling group. If the CLD and SFD are put to the test, it allows for new insights. The person or group giving feedback is likely to ask simple questions about the problem, how and why certain links are placed in a certain order, etc. These naïve questions serve to clarify assumptions and limitations. Always explain the mental model as your personal or the group's understanding of the problem to emphasise that there are other ways of understanding the problem. Although group model building helps reduce bias, bias still exists but in more subtle forms. Generalisation is often the key to understanding complex systems. Modelling is without exception based on some sort of recipe. Irrespective of approach (i.e., recipe), all methods should focus on answering a specific question.

The modelling process here is put into context of the learning loop. The group model building process can be described using the learning loop (Figure 3.7). The Learning loop is a roadmap towards understanding the problem. It helps the group analyse what stage in the learning process the group is situated. The learning loop is also valid for building simulations, but the focus in Figure 3.7 is on the mental model since it precedes the simulation phase (Haraldsson, 2005).

Modelling never starts with data collection. Data collected without a clear purpose will only add confusion to an already complex problem. All research starts with a definition of a problem and through that an understanding of that problem. Then a question is formulated around the problem. After a model has been created, it can be tested and challenged. Only then can there be a specific demand for data. Only data relevant to the problem is needed. The rest must be discarded when sorted. Testing the group will develop new understanding of a model. The model development requires several iterations and will continue as long as there is sufficient data from experiments or literature to support testing the model. During these iterations, the definition of

the problem and the questions that address the problem will improve. This process will also improve the effectiveness of the communication of the model both to the user and the developer. Furthermore, this approach enables the group to communicate the success and problems encountered in a structured way. The group's conclusions are based on the knowledge that is available to the group at the time. Any new information may change the problem definition and render the conclusion invalid.

3.4.2 Building a numerical model as a secondary step to mental models

In System dynamics research, SD-tools are used to run the numerical simulations. These SD-tools use System dynamic tool diagrams (SDTD), which are graphical versions of the mental model adapted from the CLD and the SFD for the numerical domain. The literature available, however, is not consistent as SFD and the SDTD of a particular tool are not equivalent.

The SDTD is neither a CLD nor a SFD but a hybrid SFD that includes a CLD. Solely relying on the SDTD may cause the loss of some of the learning and communicative features provided individually by a SFD and CLD, leading to less control over the learning process. In System dynamics, numerical models are built using a tool-specific SDTD. The SDTD is an interpretation of both the SFD and the CLD. The SDTDs vary considerably between the tools, something the reader can easily ascertain by comparing the same model made in STELLA, VENSIM, POWERSIM, SIMILE, CONSIDO, EXTEND, or similar software.

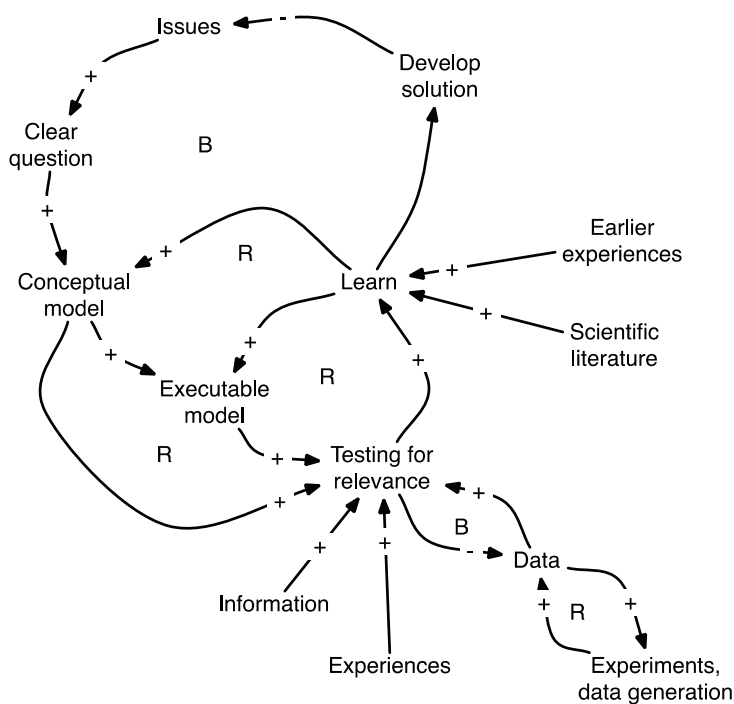

Figure 3.7. The learning loop is a roadmap for designing the mental model and a tool for the group model building process, modified from Haraldsson (2004) and Haraldsson and Sverdrup (2004). Keep it with you whenever you do a project. This is your basic methodology. There is no issue you cannot apply it to.

Numerical models are an inherent part of the System dynamics approach, but it is necessary to make a clear distinction between the qualitative and quantitative stages of the modelling process. The process of building a numerical model rests on a mental model mapped through CLDs and SFDs. Using an SDTD as a continuation to the qualitative stage not only illustrates the feedback processes and causalities but also simultaneously illustrates the properties of the variables in the model (i.e., a level or rate). This can bring some problems to the causal mapping of the system. The SDTD may lock the mental model into a process that is unintentionally linked to numerical values and may restrict the boundaries of the model to the number domain presented in the SDTD. This differs from the CLD, which only maps causalities and the SFD, which only maps the flux pathways. A CLD looks at the system from the properties of causal feedback loops only, not on the quality or properties of the system variables (Richardson, 1986). Therefore, it is possible within a CLD to link variables on multiple hierarchy levels to show only causalities regardless of numerical values.

Furthermore, it is beneficial to construct the SDTD from the CLD combined with the SFD. When this is the case, numerical values are considered a part of the model, which becomes fixed into the hierarchy and the temporal sphere the numerical values represent. The initial conditions of the system boundaries become set for that particular model, based both on the feedback loops of the system's variables and on the variables' numerical values. The equations can then be extracted from the model through the structure of the SDTD. In addition, from the CLD and SFD, coefficients can be established through the numerical domain and the SD tools can provide the testing (Figure 3.8). Not all questions require a numerical model to explain a problem. Some questions require only the performance that can be answered with a CLD, whereas others require more sophisticated answers through simulations. Depending on the answer, the modelling procedure can be divided into four implementation stages (see section 4.2), which are represented in Figure 3.8.

Abbreviations CLD = Causal loop diagram SFD = Stock and flow diagram SDTD = System Dynamics Tool Diagrams FD = Flow diagram

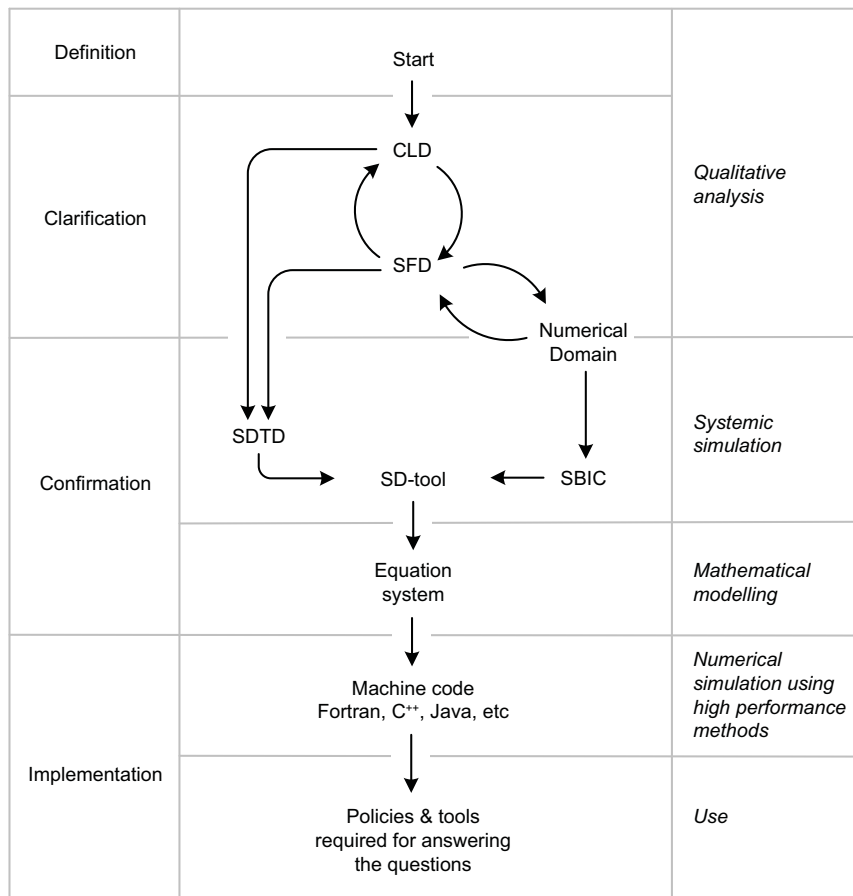

Figure 3.8. Summary of workflow in the modelling process, from qualitative analysis to building a numerical model, showing the relationship between the CLD, SFD, and SDTD. Each phase involves a different level of detail for analysing and answering the question.

A CLD only looks at the system from the properties of the causalities and feedback loops, not from the qualities or properties of the system variables (Richardson, 1986). That is, a CLD can link variables on multiple hierarchy levels, regardless of numerical values, to show only causalities. Therefore, it is possible to construct a SDTD by combining a CLD with an SFD. When this is the case, numerical values are considered part of the model, which becomes fixed into the hierarchy and the temporal sphere the numerical values represent. The initial conditions of the system boundaries are set for that particular model based both on the feedback loops of the system variables and on their numerical values.

The equations can then be extracted from the model using the SDTD as well as from the CLD and SFD, coefficients can be established through the numerical domain, and the SD-tools can provide the means for testing (Figure 3.8). Not all questions require a numerical model to explain a problem. Some questions require only the performance that can be answered with a CLD, whereas others require more sophisticated answers through simulations. Depending on the answer, the modelling procedure can be divided into four implementation stages (see section 4.2), which are represented in Figure 3.8.

The definition phase represents the conceptualisation of the problem through the CLD. If the answer requires a numerical value, the CLD is converted into an SFD in the clarification phase. The SFD is developed by considering the range and values for the variables in the model. This is an iterative process between the CLD, SFD, and the numerical domain represented by the SDTD. For example, the discovery of some rule in the numerical domain may alter the structure of the SDTD and subsequently the CLD and the SFD. In the confirmation phase, the SDTD is constructed and the SBIC is put into a SD-tool. Scenario and sensitivity analysis are run to test the model within the set SBIC. The question is ultimately considered answered and documented in this confirmation phase. In the implementation phase (Figure 3.8), system equations are extracted using the SD-tools and used as a base for programmed applications. Programmed applications are needed to cope with large and complex databases that are used as input data. Furthermore, programmed applications optimise the calculation speed of the numerical model and the handling of the input parameters (e.g. SAFE and FORSAFE). The SD-tools have a limited capacity to run large complex models with complex input data due to the lack of computational power, but SD-tools can be used to develop a good overview of complex numerical models. The four phases described in Figure 3.8. will be discussed in detail in section 3.6.

Although creating a CLD can be a simple way to present the causalities in a mental model, their conversion into an SDTD and vice versa has proven to be difficult for inexperienced users. The process is especially difficult if the user needs to be familiar with both concepts. Until now, this process has required considerable training to master. Recently, a simplified method has been presented that translates a CLD into an SDTD (Burns, 2001). This method was further developed by Binder et al. (2004) to develop the principles for the software. This method enabled direct modelling of the CLD and omits the need to learn the SDTD concept so that even the novice can create software simulations from a CLD.

3.5 The extended learning loop and the innovation process

Most System Dynamics research starts with a definition of a problem and concludes with measures and predictions through simulation. However, there are some differences in how the procedure is advocated, especially when the hypothesis is being developed. As previously discussed, some prominent researchers advocate the use of the SDTD (along with CLD) when developing the mental model (Ford, 1999a; Sterman, 2000). Others stress using a qualitative method (such as the CLD) as a primary tool when explaining the mental model and analysis before using simulations (Randers, 1980; Maani and Cavana, 2000).

In chemical engineering, several agent-based tools for specialised engineering design are available for process and unit operation simulation, which typically have SDTDs with many flow diagrams. Using qualitative analysis before computer simulation can allow for adjustment of the hypothesis and the focus of the initial question (Haraldsson and Sverdrup, 2004). Furthermore, such an approach can reduce the importance of using the simulation as the primary problem solving approach (Cavana, 1999; Elias, 2001; Cavana, 2004; Cavana and Mares, 2004; Elias et al., 2004). However, quantitative simulations do not replace qualitative methods. Rather, the numerical model should be used to confirm or refute the hypothesis and should only occur after the mental model has gone through the necessary testing.

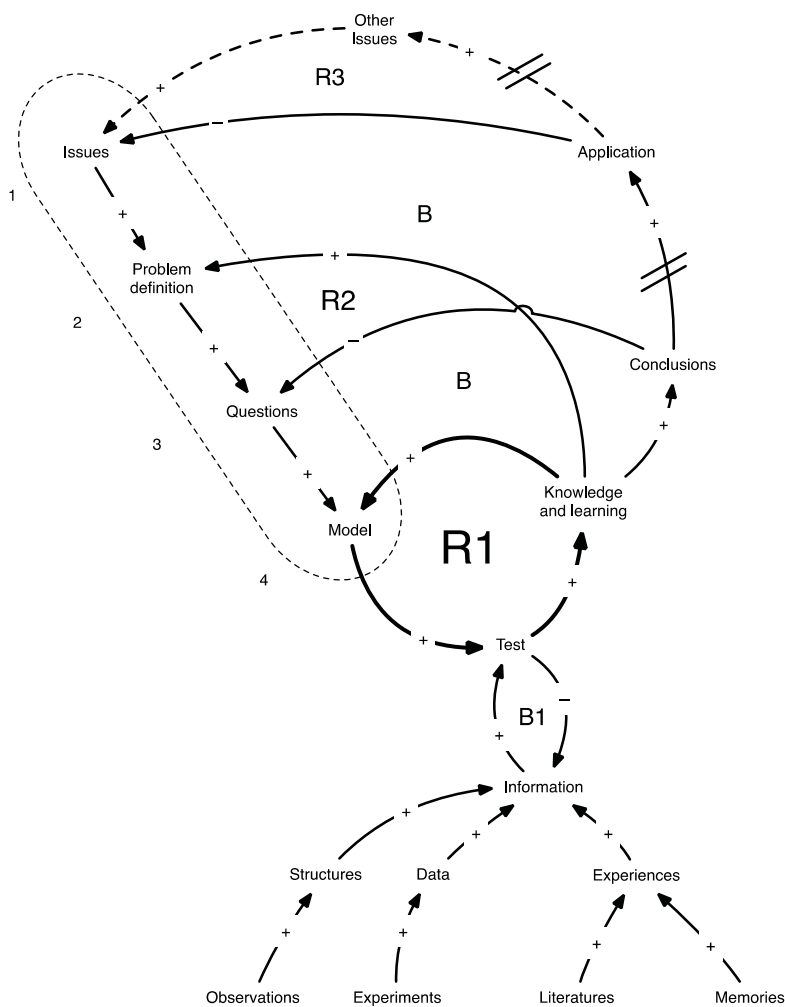

Figure 3.9. The use of extended learning loop model results in adaptive learning.

3.5.1 The extended learning loop model

In System analysis and System dynamics, hypotheses are considered dynamic and their modification a process in itself (Homer and Oliva, 2001). A hypothesis can be regarded as a set of questions derived from an analysis of the problem and used to establish the goals of the study (Dörner, 1996). Thus,

when the questions change, the hypothesis changes. The following is a description of the process called the extended learning loop, which is shown in Figure 3.9.

All modelling inherently uses the extended learning loop although many modellers are unaware of this and therefore it is not an explicitly managed process. Only by intentionally using the approach can the full potential of the process be exploited. When a problem is first encountered, the information is normally quite unsorted and disorganized. Often, modellers are presented with a mixture of issues, problems, symptoms, worries, complaints, proposed mechanisms, and fragments of solutions. To make sense of all this information, it must be sorted, organised, and structured by extending the modelling procedure described in 3.1, the extended learning loop (Figure 3.9). The sequence is as follow:

1. The symptoms are discovered when dealing with the issue for the first time (step I).
2. The definition of the problem emerges after the symptoms are explained, the hidden causal structures affecting the problem are mapped, and the feedback mechanisms are explained. That is, the dimensions of the problem are discovered (step I).
3. A specific question is addressed and the system boundaries are identified for the problem (steps II-III).
4. A CLD and SFD model are constructed (steps IV-V).

The iterations of the testing and revision are done in steps VI-VII. The extended learning loop reiterates the knowledge gained from the testing of the models, which is then used to re-address the question and the problem. This new knowledge helps reorganise the model structure as well as promote new questions and definitions of the problem. Mistakes and misfits are essential parts of understanding the system's fundamental behaviour and provide the information that can be used to reject proposals that will not work. This iterative process improves understanding of how the symptoms of the problem manifest, information used to more accurately define the problem. The model is tested against different types of information (data, personal experience, events, literature, etc.) to further refine the understanding of the problem. All System dynamics studies end (step VIII) by providing answers to the questions asked and employing corrective measures for the removal of the original symptoms or creation of new behaviours (symptoms) favourable for the project. This new understanding gained from the analysis raises new questions and possibly identifies new symptoms. Identifying what constitutes a symptom and what constitutes a problem requires sorting and a mental model (see section 3.1). Once the question has been identified, the mental model will become more definite as it will more precisely and accurately define the structures, boundaries, and components.

3.6 Group modelling: The four innovation phases

Group modelling is an important part of any model building because it enables better focus towards solving messy problems than if approached individually (Vennix, 1996; 1999; Checkland, 2000). Group modelling has become an inseparable part of understanding and managing complex problems and therefore the steps towards working out successful solutions for a problem rest on the success of the group modelling.

Group modelling involves gathering people who are both stakeholders and problem owners and who have a unique understanding on different parts of the problem. It also involves having a System dynamics expert to facilitate the group process with the goal of creating a decision support system. Considerable research has been put into understanding how individuals within a group can be encouraged to conceptualise a problem into a manageable structure for decision support (Randers, 1980; Vennix et al., 1992; Dörner, 1996; Vennix, 1996; Andersen and Richardson 1997; Ford and Sterman, 1998; Vennix, 1999; Maani and Cavana, 2000; Sterman, 2000; Rouwette et al., 2002; Maani and Maharaj, 2004). The literature identifies several common steps that have been recommended for the group modelling process: problem identification, conceptualisation, model formulation, evaluation, and implementation (Table 3.1). This applies to conceptual modelling (qualitative analysis) as well as simulations of the modelling (quantitative analysis). This group modelling process goes through four innovation phases: definition, clarification, confirmation, and implementation (Figure 3.9).

3.6.1 Definition phase

First, the research problem and identification of system analysis tasks are discussed. In this phase, stakeholders and problem owners are invited to participate to acquire information about system symptoms and define the boundaries of the problem. When needed, experts are also invited to join the group. The understanding generated during the group modelling sessions is used to design new experiments to increase the understanding of detailed processes within the problem being studied. Asking the right questions helps identify how the symptoms are manifested in the problem structure. Next, the hypothesis and the study goals are identified. Information on system symptoms is acquired and the system boundaries are defined. Participants ask the relevant questions (developing a hypothesis), define success for the project, and design the first structures (through CLDs). Several iterations of the learning loop are made. Computer simulation can be part of this phase to test assumptions of posed questions.

3.6.2 Clarification phase

Conceptual models are created using graphic representations of the problem. In this phase, both CLDs and SFDs are iteratively used as search and construction tools. The first conceptual structure of the problem is developed through CLDs and then continued using SFDs, which in turn are used to backcheck the CLDs. The hypothesis and the study goals are developed and refined. A CLD describes changes in causes and effects. Stocks and flows in the system are properties emerging from the CLD. From the CLD all coupled differential equations can be derived. The change in the system can be analysed graphically in the CLD in a move that is analogous to differential analysis. In an SFD, the stocks and flows are explicitly displayed; however, in differential equations, linking the system components is only implicitly conveyed. Using an SFD, the modeller can derive mass balance calculations. If information from new experiments or experiences initiated by this ongoing process becomes available, it can immediately be used to improve the understanding of the system processes and improve the CLDs and SFDs. Eventually, enough understanding can be generated to provide the documentation for translation into a computer simulation tool that can be used to analyse the system feedbacks dynamically.

The CLDs and SFDs are tested by comparing the Reference behaviour pattern (RBP) derived strictly from the diagrams with the comparable graphs derived from Observed behaviour patterns (OBP). Any discrepancy between the OBP and the RBP will call for an assessment of the adequacy of the derived model and possible revisions of the CLDs and SFDs.

3.6.3 Confirmation phase

The confirmation phase is when the system structure is verified. That is, it represents a breakthrough in understanding what the right question is and what the key components are. In addition, this phase sets the final system boundaries, assumptions, and limitations of the study. The constructed model is used to validate the hypothesis and the goals by testing the CLD and the SFD. In this phase, the SDTD is constructed using the information stored in the confirmed SFDs and CLDs. That is, this phase is when the first version of the numerical domain is confirmed. After this, the SDTD is also iterated in a learning loop manner. The hypothesis is tested iteratively using the extended learning loop (Figure 3.9) where the predictions and assumptions created in the discovery phase are run against experimental data and data from other research (or expert experience). The study is concluded when the research questions are answered and validated and uncertainty is documented. Stakeholders and problem owners document the results and new questions are generated from the modelling.

3.6.4 Implementation phase

The implementation phase is when the policies and tools are developed and implemented from the new research findings. The true performance of the model is measured, and experience gained is used to develop questions for further research. A thoroughly planned project that involves careful documentation through all steps will enhance the understanding of the behaviour of the problem, leading to discoveries of mechanisms that otherwise would have been overlooked. As discussed by Homer and Oliva (2001), the System dynamics modelling produces a dynamic hypothesis that is adaptive. Changes to the hypothesis are very likely to occur since the initial knowledge of the system is not fully understood by the group. The purpose of listing the four innovation phases is to create the awareness necessary for the group to adapt to and accommodate for the changes in the modelling process and the hypothesis.

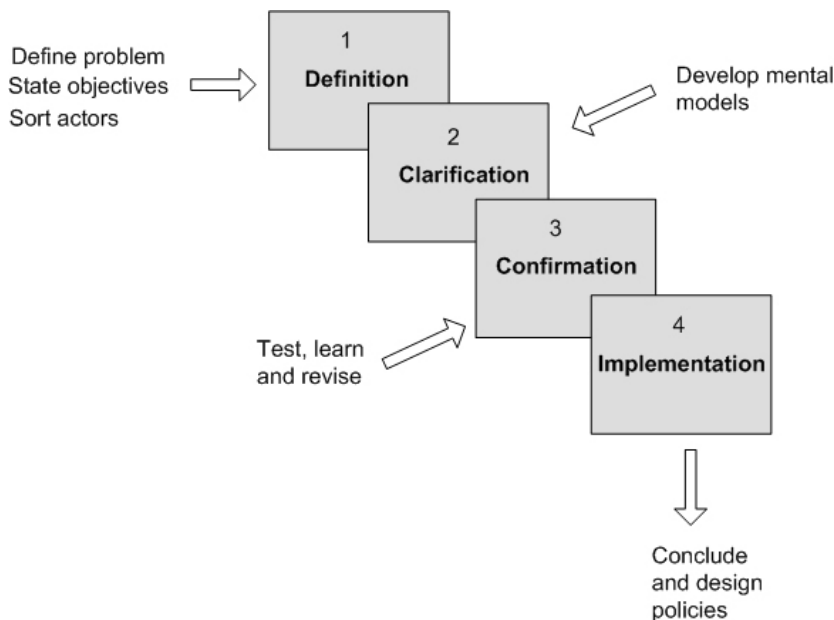

Figure 3.10. The four phases of group modelling and systems analysis.

Figure 3.11 summaries how group modelling (Group domain) becomes a participation process requiring several meetings to prepare and define the task, to clarify the system structure, to confirm understanding, and to implement and document the knowledge gained. Each meeting in the participation process completes at least one round through the learning loop, documents the process, and transfers that understanding to the next meeting phase. Preparation and documentation is done through homework (Homework domain) between each group modelling meeting. When the group has reached a consensus on the understanding of the system, the knowledge is documented and used to support the necessary decisions for improving the system conditions. The implementation is also a real test of the original question and hypothesis, ultimately used to evaluate whether the understanding generated from the process is useful. Realizing that the group modelling process goes through

the four phases gives the group an idea where the group is positioned in the process and remains to be done to confirm understanding that will eventually lead to implementation of the solutions formulated.

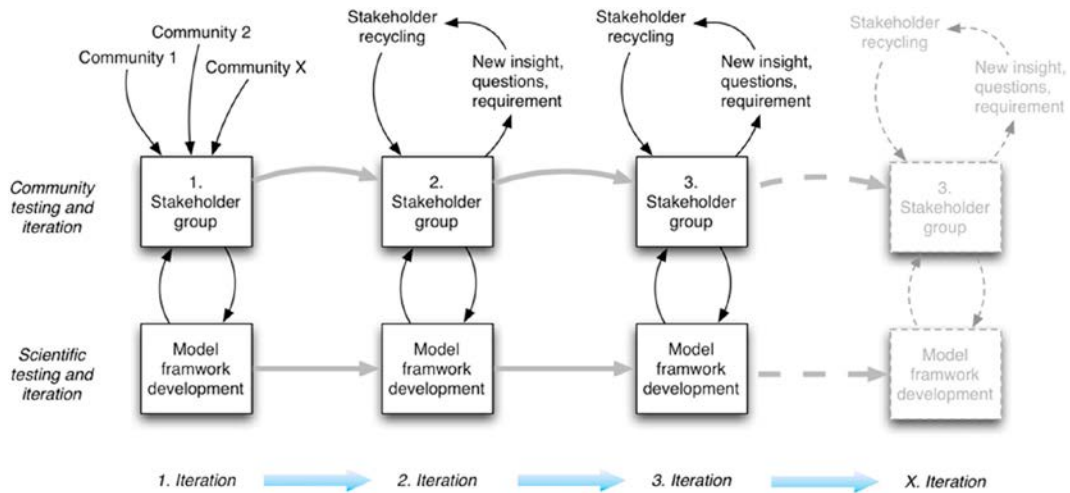

Figure 3.11. Summary of event flow in the group modelling (Group domain) process and homework (Homework domain), which involves four phases and the learning loop in each phase.

Managing the group modelling process can raise issues related to power games, group think pressure, prestige, etc. Therefore, the four phases are intended to aid both the facilitator and the stakeholders to identify where their decisions are leading the group and if they are moving the process forward. The System dynamics approach described above becomes an adaptive learning process where the four innovation phases emerge as inherent parts of the process.

3.7 From conceptual to mathematical model

The following discussion of models and simulations refers to models made by SD-tools unless otherwise stated. As discussed earlier, SD-tools are good for creating an overview of a system, but they lack the power to run very complex models. Before any attempts are made to transfer a theoretical model into a numerical model, the mental model and its feedback loops need to be fully understood (Randers, 1980; Ford, 1999a; Maani and Cavana, 2000; Sterman, 2000) as there are fundamental differences in how the user experiences a mental model and a computer model.

When using a mental model, the user creates a reference behaviour from the mental model by using intelligent guessing informed by the behaviour of the variables according to the rules provided by the CLD. When using a computer model, the user presumes that the guessing is done by the software, so the user no longer uses intelligent guessing – i.e., the user lets the software run scenarios. This has advantages and disadvantages: the user now can test the assumptions in the CLD and check its performance with simulation, but

the user might not fully understand the results produced by the simulation and therefore will not be able to accurately interpret the graphs. The SDTD may tempt the user/developer to focus on numbers far too early in the process, drawing attention away from finding, implementing, and completing the system structure. Therefore, there is a risk that the SDTD will be constructed from another mental model rather than from the original CLD. This difference stems from the added complexity that the SDTD introduces.

To run a simulation, a user needs to understand how the stock and flow components and feedbacks are represented in the numerical domain. Several studies have shown that understanding SDTD feedbacks and the graphs produced by simulations is initially limited (Sweeney and Sterman, 2000; Ossimitz, 2002) as a fundamental understanding of basic mathematical concepts is sometimes lacking (Jensen, 2003). The use of computer models requires elemental understanding of maths and how they are used in simulation. Therefore, training in model building is needed. The purpose of the model is to answer a question or a set of questions. The model is a map of the symptoms and the underlying causality structure that includes the scope of the questions (Figure 3.12). The symptoms are the manifestation of the problem and any analysis (e.g., group model building) aimed at mapping the unseen causes of the symptoms and their underlying structure. The system boundaries inscribe the mapped causality structure but do not include other causalities in the problem dimension that can indirectly be linked to the original question. Unknown structures may contribute to the symptoms of the system but are unknown in themselves. The manifestation of a problem is seen but not the cause since the problem's structure is unknown. Once made visible, previously unknown structures reshape the problem and the definition of the problem. For example, Pasteur formulated germ theory to explain disease after discovering bacteria, an insight that revolutionised health care. Because feedback structures can remain invisible to some in a group but visible to others, it is important to have a diverse group of people involved in the group model building.

The information here relies on Wolstenholme's (2003) assertion that clear system boundaries are important for Systems dynamics research. Setting clear system boundaries enables the modeller to list specifically what is included in the model and what is left out and enables better understanding of a model's assumptions. Specific system boundaries enable clear focus on the goal of a study and help scale a study according to the level of details and the time frame. When the CLD is translated into a SDTD and numbers are assigned to the variables, the focus of the study becomes rigid. Although physical entities may be visible, their functions are often invisible, including the relationships among other entities and functions. To answer any question regarding symptoms, the causal structure of the phenomenon needs to be mapped. The resulting model will only explain part of the problem, but a map of the causality structure can lead to the discovery of other problems and symptoms that were hidden before the analysis. A model that is constructed will be scaled

according to the time frame and dimension as soon as the user assigns numbers to the variables. For example, if studying urban dynamics, there is a difference between studying five vehicles and one million vehicles. In each case, the level of details are different.

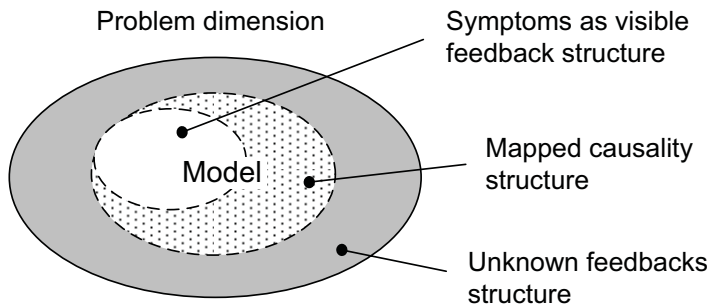

Figure 3.12. Symptoms are a manifestation of hidden causal structures. Aside from symptoms, the problem dimension includes unknown structures that contribute to the symptoms but remain invisible to the modeller.

Studying five vehicles may include conditions and durability of the components and their feedback loops within each vehicle (if that is the focus). But studying one million vehicles increases the scale and reduces the resolution of the model and therefore might require simplifications of the feedback loops of the internal components in each vehicle. This requires the modeller to make assumptions about the behaviour of each vehicle. Time frame sets the resolution of the study and assigns the appropriate hierarchy level. Modelling the internal components of the vehicle may use a time frame of seconds and limit the number of time steps the software can run. Using such resolution for modelling one million vehicles over one year would be impractical with some SD-tools and force the necessary simplification in the model. There are, of course, models that deal with such complexity that cross multiple system levels, but such models require more sophisticated programming languages such as FORTRAN or C.

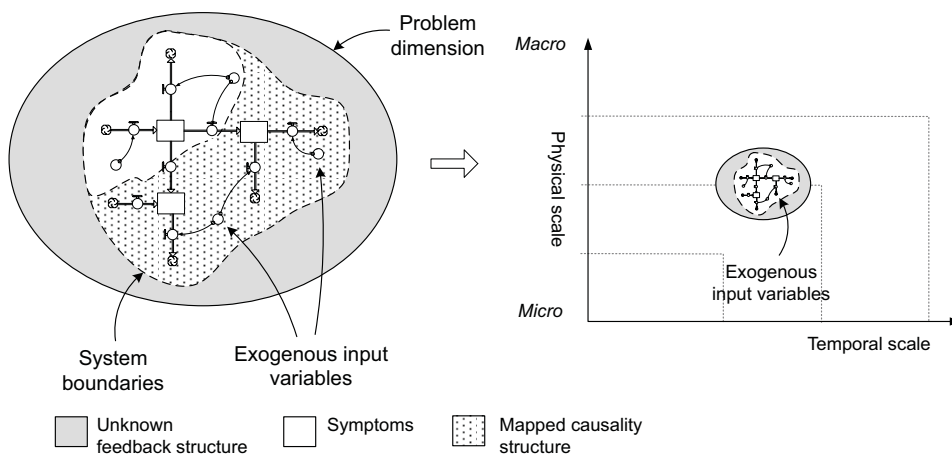

Figure 3.13. Uncertainty resides within the variables in the model and with the exogenous input data. The model makes assumptions about its lower system levels and exogenous data and therefore is placed accordingly on the scale.

Figure 3.13 illustrates a model that has been constructed to explain symptoms and their underlying structure. The scale and time frame enforce the necessary simplification of the model and place it into the problem dimension. The problem dimensions are set by the scope of the problem – e.g., if it includes natural, economic, and social aspects. The model may contain different hierarchical system levels, but the levels reside within the problem dimension (see Figure 3.12).

Uncertainty in a model originates from structures embedded in a system and from structures contributing to the system. Uncertainty in the feedback structure within the system boundaries can be identified, but not its magnitude. The unknown feedback structure also contributes to uncertainty, but it is not identified as a part of the model, so its magnitude is not known. The assumptions from the unknown feedback structures are automatically overlooked since it is related to the mapped feedback structure but not intentionally part of it. Uncertainty is twofold: indigenous (what we know exists) and exogenous (what we do not know exists). Although exogenous uncertainty is unknown to the user, it is still part of the problem dimension. Endogenous uncertainty is embedded both in the model structure and assumptions and therefore is defined; exogenous uncertainty, on the other hand, lies outside the model utilisation process so it is not defined (see Figure 3.13).

3.7.1 From CLD to simulated SDTD model – the workflow

As introduced in 3.3.4, numerical models made with SD-tools are referred to as SDTD models. If the modelling task is to build a computer model, the procedure from CLD to SDTD becomes an integrated part of the mental model construction (section 3.2). There is a wealth of literature on how to use SD-tools and how to develop SDTD to build simulations and develop scenarios (Forrester, 1961; Randers, 1980; Richardson and Pugh, 1981; Roberts et al., 1983; Grant et al., 1997; Ford, 1999a; Maani and Cavana, 2000; Sterman, 2000; Hannon and Ruth, 2001; McGarvey and Hannon, 2004). The basic components in SD software are the stocks, flows, and converters. The transition from a CLD to a SDTD can be challenging (Burns, 2001; Binder et al., 2004) as it is only possible if the variables in the CLD have been clearly sorted into actors, drivers, and conditions. The actors are the variables identified as stocks (accumulators and levers) in the SDTD. The drivers are the variables that flow per time unit, and the conditions are the calculated values of the coefficients (converters). Creating the SDTD is iterative, and the numbers are checked and the model is compared to the CLD and SFD to adjust for important changes discovered in the process. Therefore, the CLD, SFD, and their structures will be adjusted due to discoveries in the numerical domain and these changes will require changing the original question. In the SDTD concept, flow is actually a redundant parameter. Its only function is to move numbers from converters into a stock. Decisions are based on simulations of stocks and converters only. This will enable direct modelling of the CLD and omit the need to learn the SDTD

concept. In the classic engineering understanding of the term (Walker et al., 1923), SFD is sometimes confused with the SDTD, which is actually an SFD-CLD hybrid. Traditionally, engineers have used flow diagrams (i.e., stocks and flows or boxes and arrows) and differential equations have largely been kept in mathematical notation. Although the flow diagram is most widely used, there are five ways to explain a condition. Apart from drawing a flow diagram, flow diagrams can be constructed using SFD (in the engineering term), CLD, SDTD, and equations.

Figure 3.17 illustrates the following steps. Initially, the situation picture is drawn, in this case a lake with its inflow and outflow as well as the fish in the lake (which eventually is eliminated in the sorting process). The task at hand is to predict the level of the lake over time. The stock is identified from the situation picture through the SFD – i.e., lake water volume in the SFD. The arrows represent the actions in the system – i.e., input water flow and output water flow. When the actions and their controls are listed, new parameters are discovered.

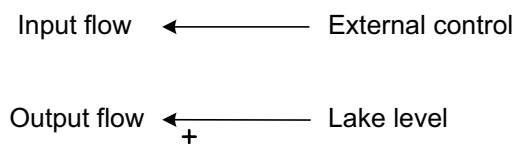

Figure 3.14. Actions and their controls.

In this case, the external control is not considered part of the system except as an input. The lake level is an internal parameter that must be investigated using the SFD already formulated.

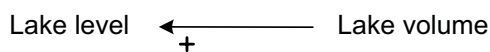

Figure 3.15. Lake volume has positive effect on lake level.

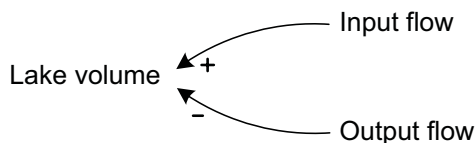

Figure 3.16. Input flow has a positive effect on the lake volume and the output flow has a negative effect on the lake volume.

With all the causal connections established, the CLD in Figure 3.17 can be easily drawn. The above records every step with total consistency from SFD to CLD as can be seen in Figure 3.17. As discussed earlier, the approach in this study has been to develop mental models with CLD and SFD and thereafter translate those to SDTD when building the simulation. One of the obstacles the users will face when constructing a computer model is translating variables in the conceptual model into tangible quantities that can be used to show numerical change in cause and effect. The mental model is always an

overview of a simulation and does not possess the details that a computer model needs to run the concepts. In the CLD concept, the user acquires the skills to map cause and effect in the problem. In the numerical simulation, an extra dimension is added – i.e., the concept of differential equations portrayed as flow and accumulation. Therefore, there are some differences in the CLD and the SDTD for the same problem. In the following simple example (Figure 3.19), the CLD does not incorporate rates as is required for the SDTD since rates are implicit in the link between the variables deaths and population. In the SDTD, the inflow and outflow parameters are actually redundant components added to the model to run the simulation. They are not necessary to explain any additional dynamic that is absent in the CLD but are necessary for the SDTD to work mechanically (Binder et al., 2004). The user needs additional details from the CLD to correctly translate into the SDTD. Translating the SDTD back into CLD and SFD will reveal additional information not perceived in the initial CLD and SFD. The rates are the added features in the CLD but are not necessary to further explain the feedback loops as is seen in the CLD represented in Figure 3.19. For smaller models, it is possible to place the rates directly into the flow component in the SDTD and obtain an exact translation from CLD to SDTD. A flow component enables control of stocks in the SDTD structure – i.e., to remove (or add) content from the stock.

Situation picture	
SFD	
CLD	
SDTD	
Equations	$\frac{dV}{dt} = r_{inflow} - r_{outflow}$ $r_{outflow} = a \cdot z^n$ $z = \frac{V}{A}$ $A = f(V)$ <p style="margin-left: 400px;"> $V = \text{volume}$ $r_i = \text{rate of flow}$ $z = \text{lake depth}$ $a = \text{coefficient}$ $A = \text{lake area}$ </p>

Figure 3.17. Examples of five ways to explain a system. SFD = Systems flow diagram; CLD = Causal loop diagram; SDTD = System dynamic tool diagram.

Using flows to solve equations hides the feedback structure that would otherwise be visible if converters were used. Although acceptable for smaller models, this becomes a real problem with complex models and reduces transparency. It becomes harder to track variables and perform any sort of sensitivity analysis. One of the best features of SD-tools is their ability to show variables in a transparent manner, giving the user the ability to estimate uncertainty and performance of each variable. The user analyses how each variable contributes to the model by using the extreme test – i.e., running the model with numbers that are clearly out of the normal range the variables produce in reality. The extreme test produces a cascading effect in the model where the user can observe the model behaviour and spot abnormalities.

Anomalies, whether logical or numerical, require revision if not reasonable when put to the test. These revisions can be small or may be critical enough that the whole question and the hypothesis are logically unfit. An obvious mistake is easy to spot, but a sophisticated one is harder to spot. Unfortunately, these more difficult mistakes tend to be classified as uncertain or simply ignored (Levenspiel, 1993).

	Question	Definition	Clarification	Confirmation	Implementation
Nouns and names	Who is the actor? What is being acted upon?	Actors Entities	Stock	SFD	
Verbs	What are the actions? (who own the action?) What controls actions? What are the decisions and transformations? (and their control)	Actions Controls or other actions Decisions, decision control	Action- control single CLD Rule or diagram		
Structures	What does the system look like?			CLD ↓ SFD	
	What should the Stella design look like?			Revise	SDTD

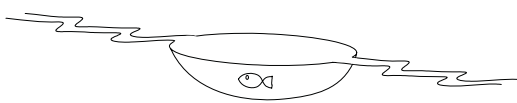
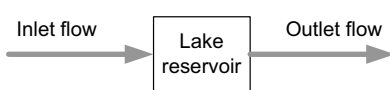
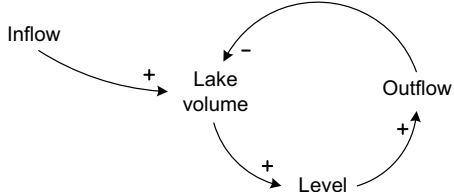
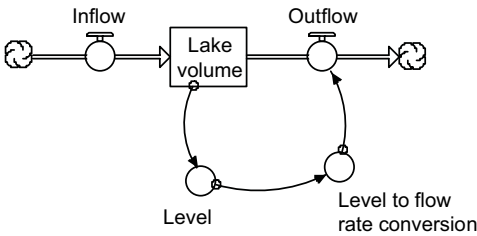
Figure 3.18. The summary of the System Analysis and System dynamics workflow.

Testing the credulity of an outcome creates the necessary iterative process between the CLD and the SDTD where the theory, structure, and numbers are tested and validated. The system boundaries only take their final form when the numerical domain has been completely set as a consequence of the testing. In this way, the numerical model is gradually built up until its performance in simulating scenarios is satisfactory. The following steps are an overview of converting a CLD into a simulation.

Step 1. Identify the numerical properties of the variables in the CLD and SFD: identify the agent variables, which are subject to fluxes (i.e., stocks), action variables, which have rate properties (i.e., flows), and condition variables, which control or limit the actions (i.e., converters). Use the snap-shot method (Sterman, 2000) to freeze the system in a moment of time. The flows and rates will not be visible thus making it easier to identify the stocks

Step 2. List the agents, starting with the core agents. Develop the flow dependencies to and from the core actor and draw the stocks and flow in the SD-tool. When making converters, avoid placing multiple conditions in a single converter.

Step 3. Perform a reality check of variables. That is, check if variables hold up to physical principles. Document all numbers used in the model and check all units. Unit consistency is the key to successful simulation.

Step 4. Test the model. Comparing the RBP and the validity of the numbers – e.g., are the numbers within reasonable dimensions and limits?

Step 5. Test robustness of the model. Use extreme numbers to check if the model can handle these values. If the model cannot handle extreme values (e.g., crashes or shows unexpected behaviour), some logical discrepancy in units or structure might exist.

Step 6. Compare the SDTD structure to the CLD and SFD structure. Check if the simulation creates a mental model different than the initial CLD and SFD. Reconstruct the CLD from the SDTD, which will lead to a possible reconstruction of the SDTD. Check if the delays discovered in the CLD phase are present in the outputs of the SDTD.

Step 7. Run scenarios, perform sensitivity analysis, and evaluate the simulation output of the initial question raised by the CLD and SFD. Verify the model.

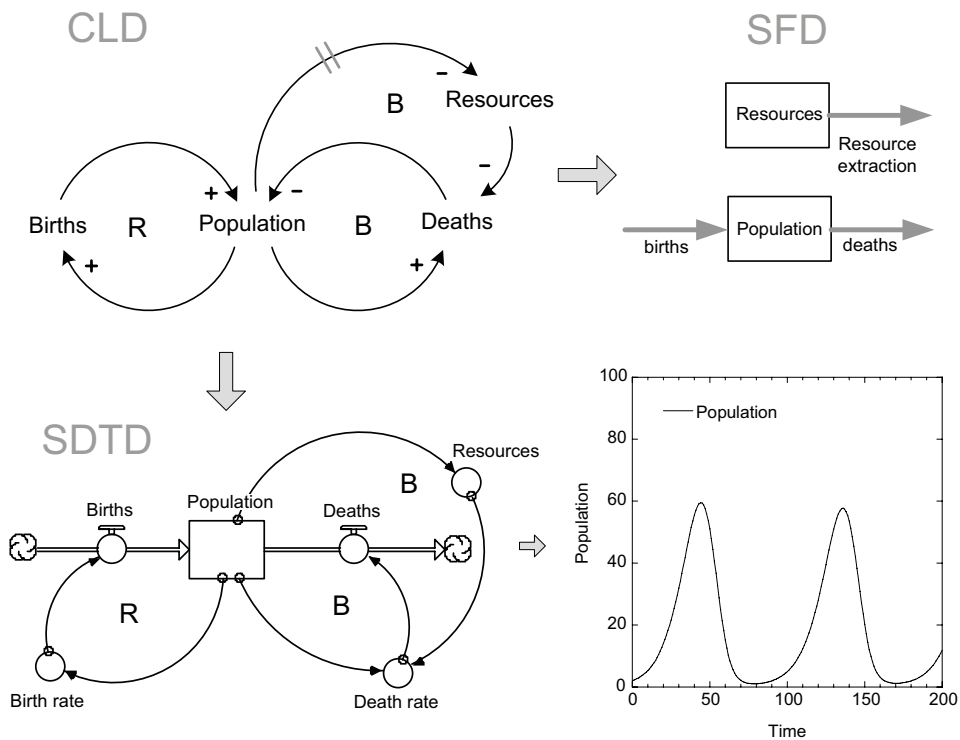

Figure 3.19. The translation from CLD and SFD to SDTD requires additional information – i.e., the rates that are required to run the simulation. Due to the simplistic nature of CLDs, the rates are implicit in the links of the CLD. Delays in the system are marked with a double strikethrough on the link.

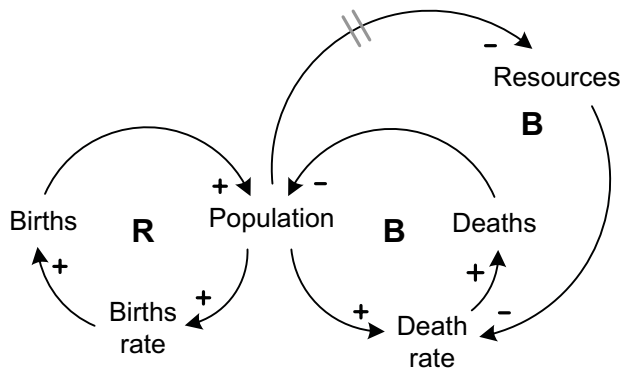

Figure 3.20. Translating the SDTD back to a CLD will produce a mental map that possesses more details than the initial CLD.

As discussed previously (section 1.2), the literature is somewhat divided on how to use a mental model to construct a computer model. For example, Ford (1999a) and Sterman (2000) advocate using an SDTD to develop the mental model although the learning curve is quite steep for novice modellers. Note that the numerical model created with the SDTD may have a different mental model behind it than the numerical model initially created with a CLD as the numerical domain tends to be unwittingly included during the initial stages in the conceptualisation phase (see section 3.2) and changes the initial mental model. This difference stems from the added complexity that

the SDTD introduces to the user when translating the CLD to the SDTD. The model builder is often unaware of this process but can discover this by translating the SDTD back into a CLD and either make the adjustment to the CLD or rework the SDTD. A modelling process that fosters the use of CLDs and SFDs before venturing into a SDTD will better prepared to adapt numerical values into the model. The SDTD workflow needs to be very simplified for the builder. The model builder should use simple words to explain every agent, action, and condition and how they are connected. However, simple words should not be confused for general words as general words such as “supply” and “demand” are descriptions of already existing models and therefore will add to the confusion rather than clarify. Using tangible or concrete language helps maintain transparency in the model.

3.7.2 Building a simulation out of CLD – An example from Iceland

As previously discussed, all coupled differential equations can be derived from the CLD. The CLD allows for transfer of change in the system to be analysed graphically, an analysis that is analogous to the differential analysis. The CLD for was developed first (Figure 3.21), which was followed by the equations (1.19). The function derived from Figure 3.21 was used to calculate the vegetation cover (A) and potential vegetation cover (A_p) under different climatic conditions and changes in the area over the whole period using the following rate functions: k_{growth} and k_{decay} , (dA/dt).

Here the mass balance equation for the vegetation system is derived from the iterations between the CLD and the SDTD. Although simplistically derived, each variable has a complex assumption built into the input data – i.e., the questions stated for the problem required construction of input data from several sources. Therefore, the computer model developed was only a part of the model. The computer model required two other models – the temperature calibration model and the digital elevation model (DEM) – to successfully run the simulations (Figure 3.22. and Figure 3.23). The modelling approach is a constant iteration between simplifying a model and making it complex and simplifying again. This iterative process helps the modeller understand the necessary complexity needed to answer this question: How much simplification is possible before the performance is not sufficient to answer the question?

3.7.3 Testing performance, DT, and uncertainties

Since dynamic systems are continuous, a simulation can accumulate errors in the numerical integration. Continuous models use differential equations, so for the software to compute the behaviour of the model the computation must be performed using numerical integration. The integration step in SD-tools is called DT (delta time), and the length of DT calculation that the model uses in each time step is called a solution interval. For stability and accuracy, DT must be smaller than the first-order delays in the simulation (Forrester, 1961). The DT affects the model performance by accumulating errors in each solution interval.

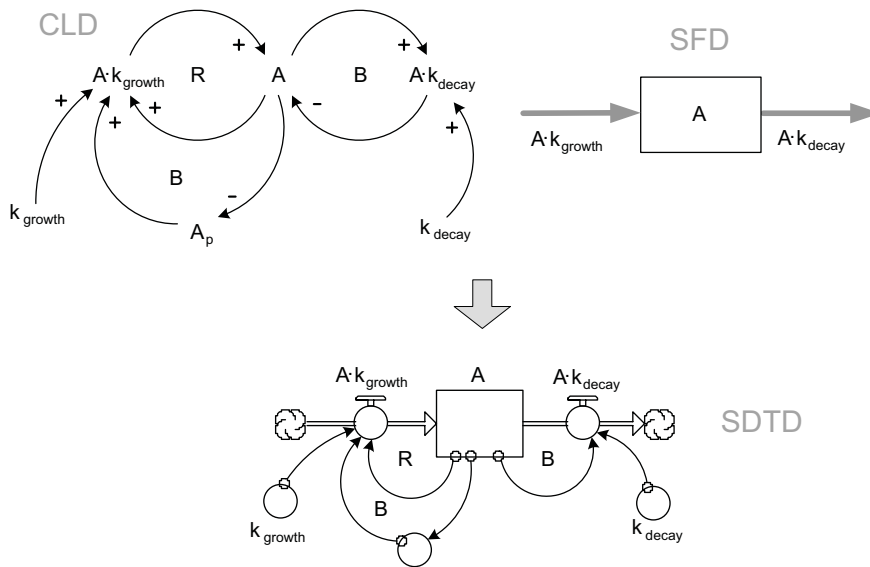

Figure 3.21. The CLD, SFD, and the SDTD of the modified logistic growth function can be expressed as one reinforcing loop being constrained by two balancing loops.

By the end of the simulation, the true performance and the simulated performance can vary. To counter this variance, a very small DT should be used. However, according to Barton and Tobias (1998), decision variables used in a simulation can introduce significant errors since the decision variables are recalculated at the end of a solution interval. Thus the decision variable implements the changes after it has gone by the critical value where it was supposed to deliver the changes. One way to counter this problem is to use a back tracking integration step, such as the Runge Kutta method. Testing a computer model is necessary to verify if it is performing according to the initial hypothesis and the assumptions about the system presented in the group model building sessions. Testing is also important for the continuation of the project as untested concepts may negatively influence the model when implemented.

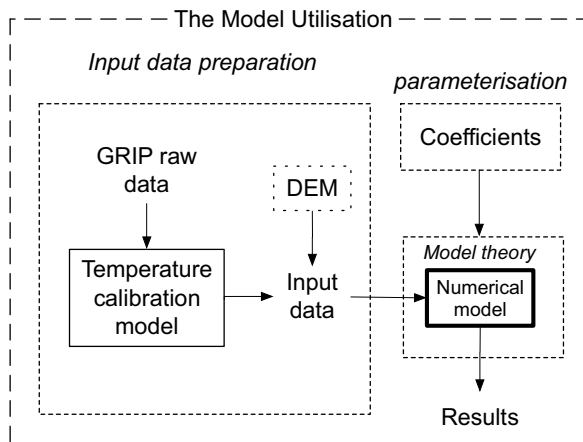

Figure 3.22. The vegetation model was simple and made complex assumptions. Therefore, it required two other models to run simulations. The naïve model view from 2001 when the study was conducted.

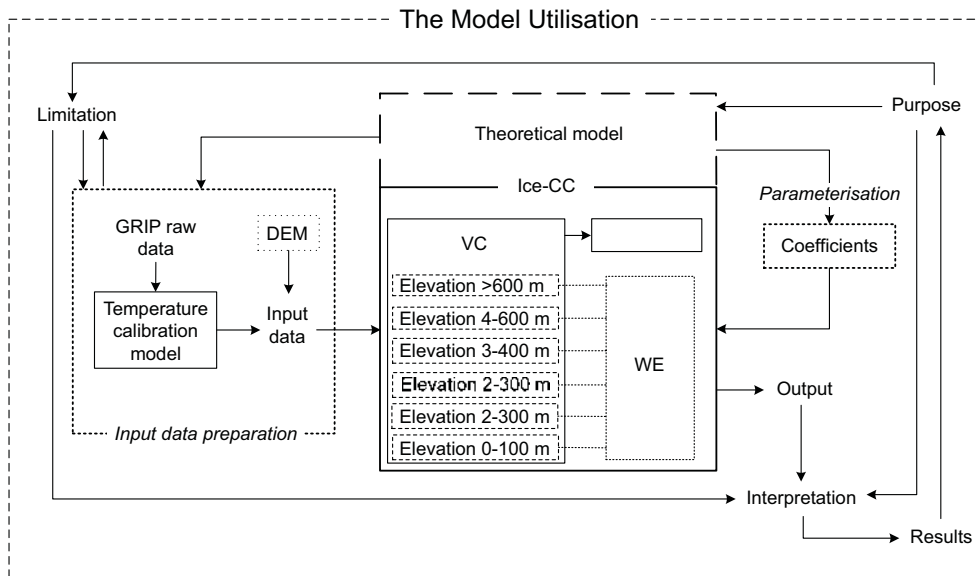

Figure 3.23. The Model utilisation view allows for clear transparency of what modules are used to support model output and results.

The testing of the model building process can be done in the following way (Ford, 1999a and Sterman, 2000). First, verify if the model produces results matching published records or documented real life behaviours. Second, test if the model violates physical reality (i.e., check whether the results are plausible in real life situations). For example, use extreme number testing to observe if the results are plausible. One of the most reliable tests is testing if the model can reconstruct past behaviour. If not, reconsider the model structure and parameters. One of the most common mistakes in modelling is inconsistent use of units. Debugging a model should first start with testing consistency of units.

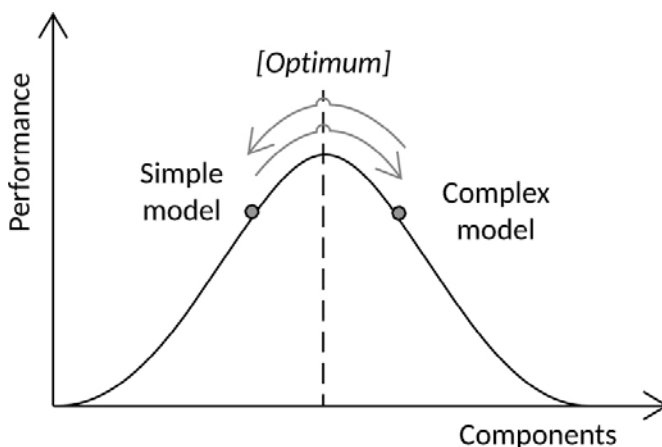

Figure 3.24. The modelling procedure requires several iterations by the modeller to find the optimal complexity of the model that will answer the question.

3.7.4 Take home lesson

The most important aspect of the process is to systematically adhere to the principles of the learning loop, sometimes called the adaptive learning process, and to be totally consistent in all system maps created – SFD, CLD, and SDTD. Because modelling requires precision, consistency between each step is the issue that decides success or failure. In the adaptive learning process, systems analysis repeats itself during system dynamics and finally during model implementations and design creation.

4 Building simulation models in case studies

In this section, we will examine three case studies of increasing complexity and difficulty using the concepts described previously: describing the problem, developing of causal link diagrams, drawing flow charts, creating the STELLA diagrams, and showing how these are actually programmed into the STELLA modelling environment. Finally, we will run the models to discover what the simulations actually look like.

4.1 The bank account and my money

Banking is an intricate part of the economy and most people have some business with the bank, even have a bank account. Below is a case involving a simple bank.



The problem outlined for this illustration is as follows. Imagine you have a salary every month and you put that into your bank account. You also get interest and you sometime make withdrawals. We want to model the amount of money in your bank account over time using STELLA.

Let's look at the equations first. The traditional way of representing the system looks as follows. Consider that in year 0 we create a bank account and put a value $A(0)$ in it. The account is subject to a fixed yearly interest rate, r . In year 1, the content of account A will be the sum of the initial value $A(0)$ and the interest earned on $A(0)$ at r :

$$A(1) = A(0) + A(0)*r = (1 + r) * A(0).$$

Consider now that at year 1 we add money, $Rev(1)$, into the account. This could, for example, be our revenues that are directly transferred into the account. The content $A(1)$ of the account will then be

$$A(1) = (1 + r) * A(0) + Rev(1).$$

At the same time, assume we retrieve an amount, $Ret(1)$, at year 1 from the account. The final value of $A(1)$ will become

$$A(1) = (1 + r) * A(0) + Rev(1) - Ret(1).$$

We can express then the content of the bank account at time t as

$$A(t) = (1 + r) * A(t-1) + Rev(t) - Ret(t),$$

where t is a discrete time variable, $A(t)$ is the amount of money available in the account at time t , r is the interest rate over the time unit interval of the variable t (years in our case), $Rev(t)$ is the revenue flowing into the account at time t , and $Ret(t)$ is the money retrieved from the account at time t .

We can use STELLA to solve this equation for $A(t)$ as a function of t . Equations as those above are very difficult to visualize, except for the specially gifted. We will proceed to show how we prepare to do this with AS, FCs, and CLDs, and how we do this before we use any software. It is very important to carefully plan what we want to program into the software before we actually start using the software. Failing to do so, will lead to problems immediately.

Mental model as causal loop diagrams. Before moving to modelling on computers, we will build a mental model of the bank account, a CLD, and a FC. The actors involved in our CLD are the bank account, the interest (which is expressed as the bank account times the interest rate), the revenues, and the withdrawals. First, list all the parameters we think are present: income, withdrawals, bank account, interest, and interest rate.

However, people do not withdraw money because money is in their account. Withdrawals are strategic, often made to satisfy a need. Thus we list the following: needs and decision to withdraw. We may map single relationships between parameters as causal links shown in Figure 4.1.

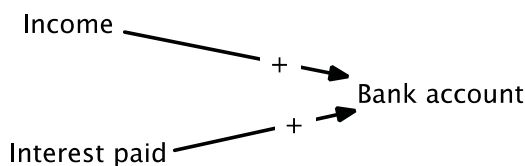

Figure 4.1. Single relationships between income, interest paid, and a bank account.

When revenues increase, the bank account increases. An increase in the interest rate increases the bank account, and a decrease in the interest rates means the amount of the money will increase more slowly. Interests are seen as increasing when contributing to the account and decreasing when increasing its deficit. When the bank account increases, the interest increases, and vice versa. We get the causal links shown in Figure 4.2.

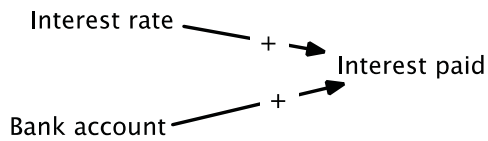

Figure 4.2. Another single relationship between interest rate, bank account, and interest paid.

Adding the variables up into one diagram, we get the causal links shown in Figure 4.3.

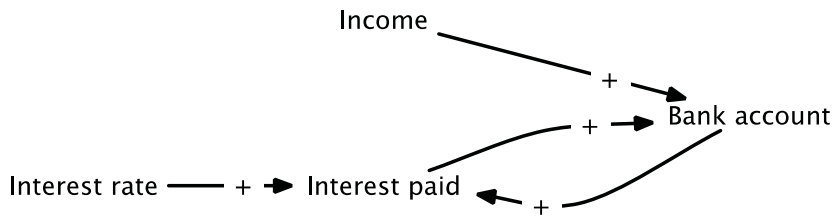

Figure 4.3. Relationships added together in one diagram

An increase in the withdrawals decreases the bank account. On the other hand, an increase in the account allows for larger withdrawals. Let's assume that we cannot make withdrawals after the account reaches -SEK 10,000. Therefore, we get the causal links in Figure 4.4.

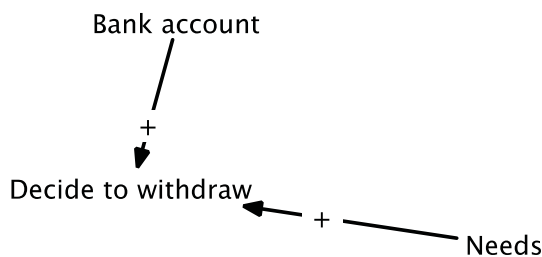

Figure 4.4. The need to withdraw money and the amount of money in the bank account both have a positive relationship to the decision to withdraw.

The decision to withdraw subsequently leads to a withdrawal, after we have checked that we really have money. If no money is there, that would probably prevent us from deciding to withdraw cash. We get the causal links in Figure 4.5.

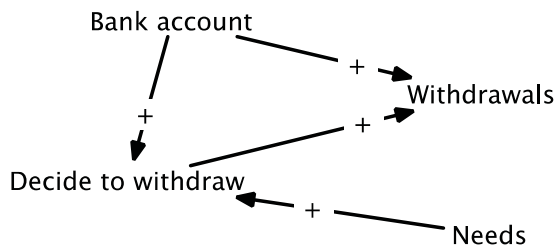

Figure 4.5. The decision to withdraw has a positive relationship with the action to withdraw.

Now, we can draw the entire account system in a causal loop diagram (Figure 4.6).

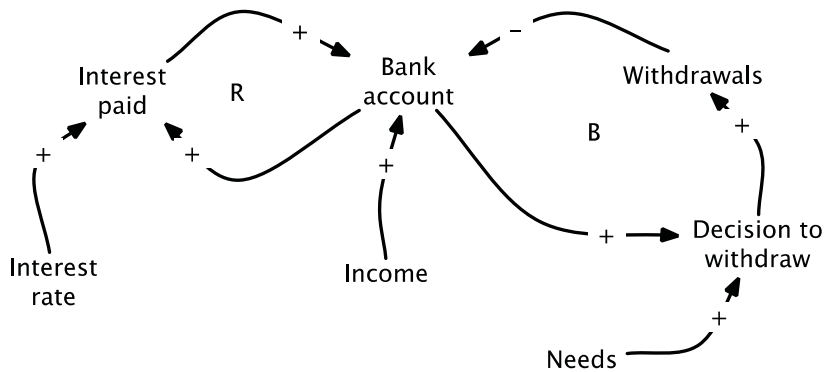

Figure 4.6. The causal loop diagram for the system.

The flow chart. A bank account can be viewed as a pool of money. Money flows into the account from revenues and out through withdrawals. Moreover, money accrued through interest payments can flow in or out of the account depending on whether the account is credited or debited. If at time $t-1$ the account is credited (negative), the interest will be negative and therefore there will be an increase in the credit, and vice versa.

Revisit the CLD. We can inspect the flow chart and see if it is compatible with the CLD we have just made. We see that the parameters are included in the CLD, except the expenditures. We have included withdrawals and we have asked what controls withdrawals, what controls spending, and what controls the interest paid.

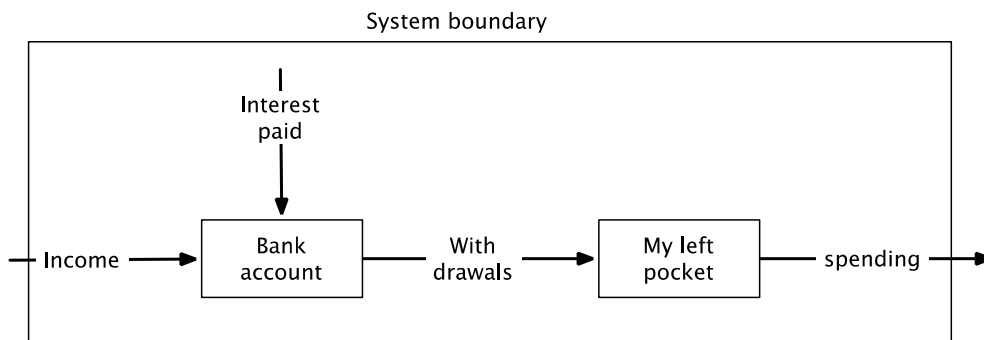

Figure 4.7. The flow chart for the system.

Finally, we update to the CLD. The flow chart and the CLD now provide 100% consistent drawings for making the STELLA model for the system. The revised CLD is shown in Figure 4.8.

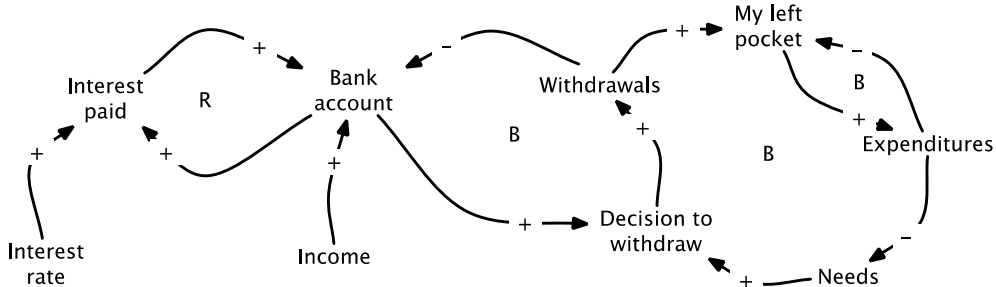

Figure 4.8. The causal loop diagram for the system.

Go to STELLA. We see from the flow chart that we need two reservoirs, stocks or boxes, where we can put things such as money. To model the bank account, we start by assigning a stock to account A (Figure 4.9).

bank account



Figure 4.9. A bank account is a reservoir that supports negative values if the bank accepts overdrafts. A negative value implies that we owe the bank money. If the banks do not accept this, then it must be a reservoir that can only be positive. This can be redefined in the software.

Next, we add the inflow from the revenues and the outflow from withdrawals (Figure 4.10). First, we add the income, then we test the model. Next, we add the costs and test the model again.

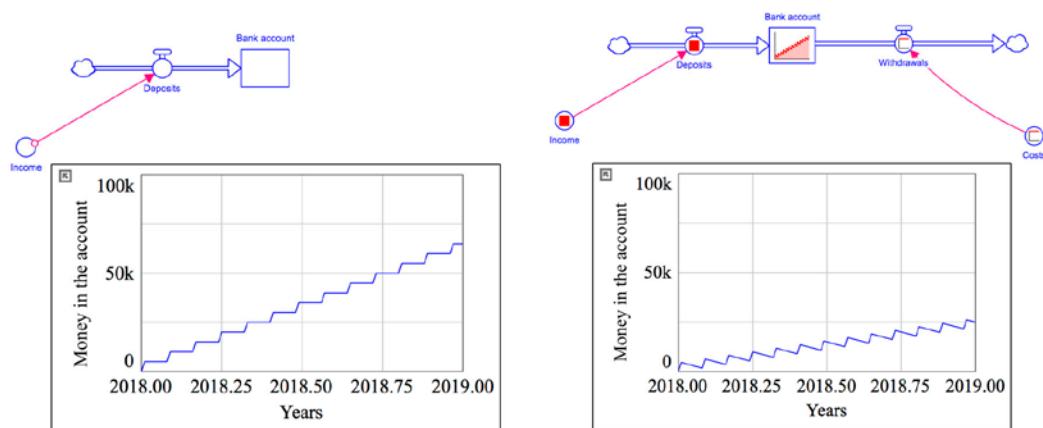

Figure 4.10. Revenues flowing into and withdrawals flowing out of the bank account.

Retrievals from the bank account are controlled by expenditures (Figure 4.11). However, our bank ceases withdrawals if the bank account falls below – SEK 10,000.

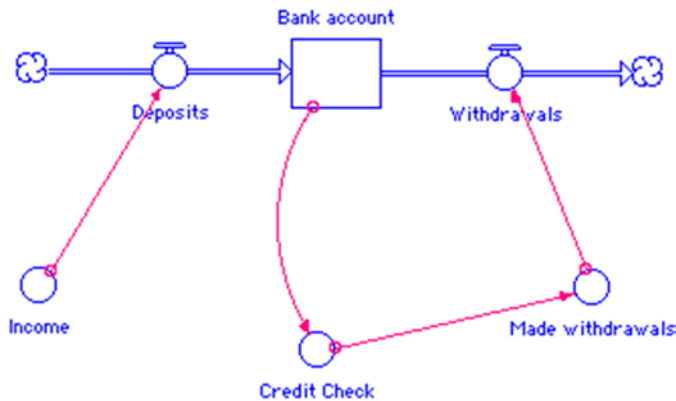

Figure 4.11. Putting expenditures and a control on the withdrawals so that the credit line of –10,000 is not exceeded. Test after each change.

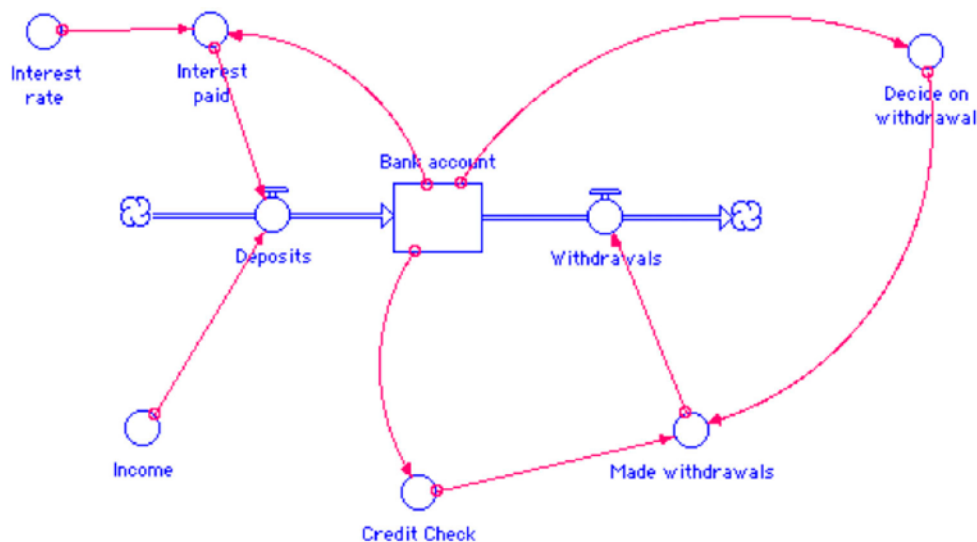

Figure 4.12. The model diagram for the system after adding the credit check.

One way to do this is by freezing (locking) withdrawals when bank account drops below – SEK 10,000. That is, the lock is controlled by the bank account, and the lock and the expenditures together control withdrawals (Figure 4.11 and Figure 4.12). The check of the bank account is done using the graph function (Figure 4.13). Open a converter (the small circles), select the variable bank account, and the press the “go to graph” button.

Set the scale for the bank account between – SEK 20,000 and 0. At –10,000, let the scale value of the curve on the Y axis go from 0 to 1. Multiply this signal by the withdrawals. If you have less that – 10,000 in the bank account, no withdrawals can be made as you automatically multiply them by 0. The completed model is shown below.

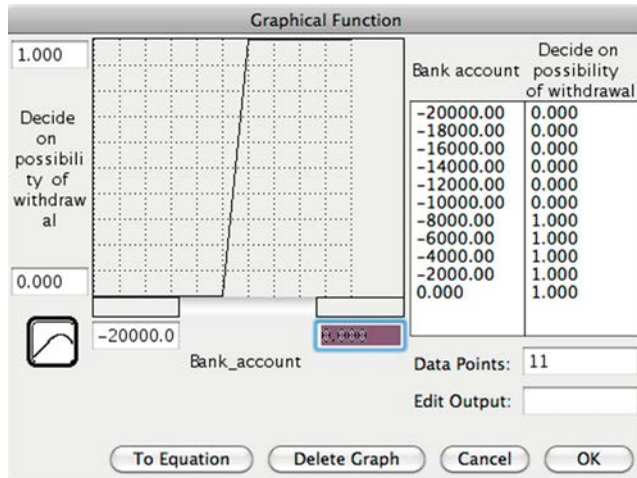

Figure 4.13. Graphical function for the bank account variable.

The model was then used to explore the dynamics of the system: How long must I work to be able to pay for the things I want to do or buy?

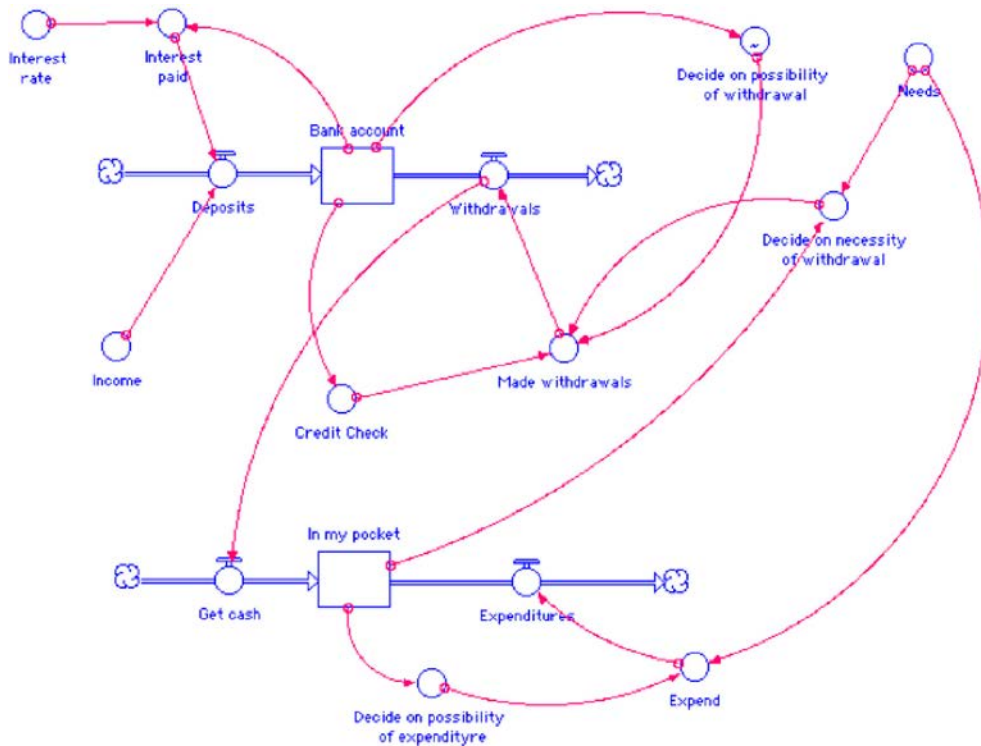

Figure 4.14. The model diagram after adding more details to the model.

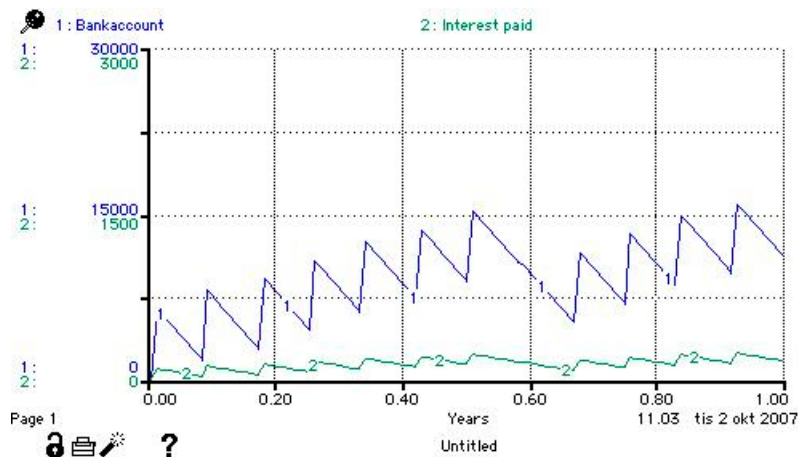

Figure 4.15. The output from the model of “my economy”.

Exercise. Now, recreate the model on your computer. Change the salary, the expenditures, and target for savings.

Remember to build the model step-wise. Do one thing, test it. Then do the next, test it. This discrete application of the process will give you control over mistakes. Add three things in a row without testing in between, and it will be more difficult to find errors when it occurs.

4.2 The economics of the apple cider business

In this example, we will again analyse a problem, draw a model, and build the model using STELLA. We will use some special features of the software: the conveyor and the pulse. In addition, we will follow the normal procedure by creating a CLD and flow chart and building a STELLA model.

The storyline. I inherited an apple orchard from my father, old Sören Äppelquist, after he died one late autumn in 2007. I spent many summer weekends at the orchard when I was a boy, now I miss the old man and his life in the slow lane. The apple orchard is in Kivik, in the part of the Skåne province called Österlän. I was there a lot in my childhood; I remember the lush apple orchards and the breeze from the nearby sea. Now, at the age of 52, I have inherited the place and for a while wondered what to do with it. Maybe something more than just having it as a vacation home. I try to run it as a business as the orchard produces a lot of apples every year. In the fall, I press the apples to make my genuine Haväng Epplemost, which I bottle and sell at the market (figure 4.16).



Figure 4.16. Eastern Skåne landscape has gently rolling hills and fantastic apple orchards. Much of the apples are used for wine, juice, and apple cider. The region is worth a visit in the summer.

Each 1-litre bottle I sell for about 12 kronor. I buy new bottles for 0.50 kronor and use bottles customers return (about 30% last year) for 0.25 kronor per bottle.

The machines I use are old. However, they are simple and have crude mechanics, so 2% of the bottles break in the washer and 4% in the bottling machine (filling, labelling, and corking). The transit time in the washer cycle takes 20 minutes and the bottling five minutes.

I have to pick the apples myself before pressing them and filtering the juice. I get about SEK 11,000 litres of juice per year from the 20 tons of apples I pick.

Picking apples takes about two weeks, the pressing and filtering two days, the bottling one day, packaging for transport and warehousing two days, and selling them about two weeks.

It costs me 20 kronor/hour to run the washer and 20 kronor/hour to run the bottler. I can run the machines for 5–6 hours per day.

What kind of profit does this bring me? How much cash do I need to purchase all the bottles upfront? Is this something I can live from or is it just a hobby that covers its costs?

Analysing the problem. The problem has the following components:

1. Bottling all the apple juice.
2. Washing all old bottles in batches until all old bottles in stock are washed.
3. Calculating costs.
4. Calculating income.
5. Subtracting costs from income.

Solving the problem. We start by drawing the system. Maybe the easiest way to start is to make a flow chart for the bottles without considering whether the bottles are full, broken, whole, clean, or dirty. Just follow the bottles in whatever state they exist. This simple flow chart follows the different flows of bottles in the system. The bottles flow into my system from return bottles and new bottles I buy. I stack them in the garage, run them through the washing machine, store the clean bottles, and then put the bottles in the bottling machine. Some are lost to breakage, but those that survive the machine go into the stock full of juice. Eventually, the bottles are taken to the market where they are sold. Some of the bottles make their way back, but some are lost never make their back (Figure 4.17). After creating the bottle flow chart, create a simple flow chart for the apple juice (Figure 4.18). The apples (the juice in its rawest form) flow from the orchard during harvest and eventually end up in a customer's hand as juice, with several stops along the way, including spending time in the warehouse. After completing the apple flow chart, a flow chart is created for the flows of money in the system (Figure 4.19). The money flows from the sales of the bottles back into the box (business), but the costs come out of the box as well – i.e., the costs for harvesting the apples, purchasing the returned bottles, buying the new bottles, washing the bottles, bottling the juice, etc.

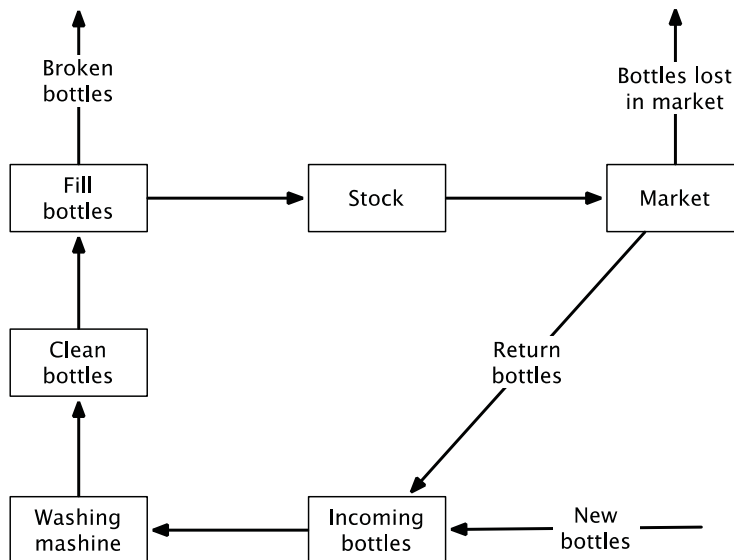

Figure 4.17. The flow chart for bottles through the system. Note that the system includes the customers. The bottles can be located in six stocks. Now, give every flow a name to make sure you know what to put in the CLD.

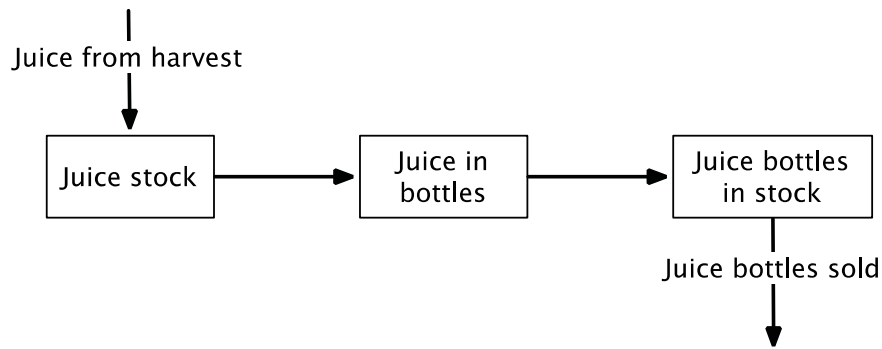

Figure 4.18. The flow chart for juice. In our adaption, the juice can stay in three places.

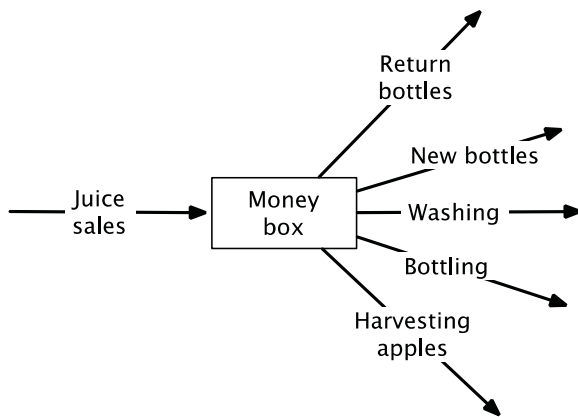

Figure 4.19. The flow chart for money.

The flow charts shown in Figures 4.17–4.19 define what needs to go into the CLD (Figure 4.20). Some are spelled out by the names on the stocks, some are represented by the actions hidden in the arrows. In addition, the flow chart should include the actions and their causes represented by the arrows. All of this information goes into the CLD. At the end, the CLD and flow charts must be completely consistent. Not approximately, but totally consistent.

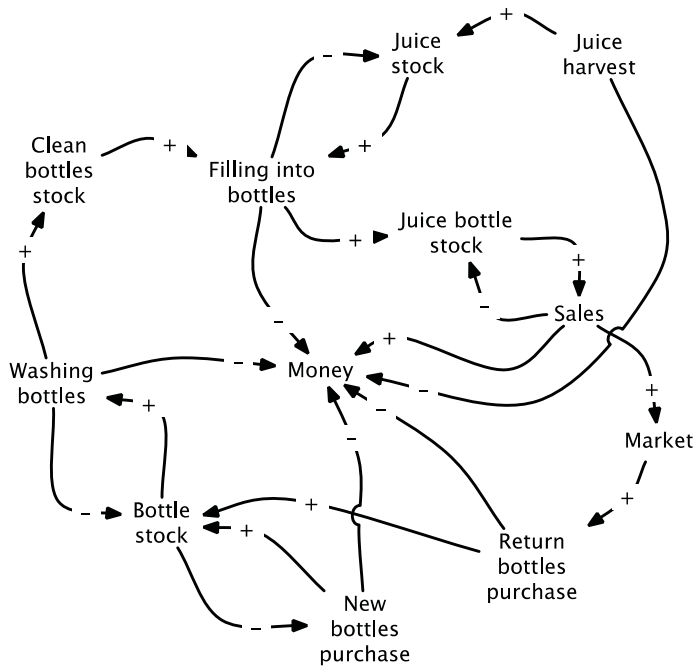

Figure 4.20. The causal loop diagram drawn with help from the information depicted in Figure 4.17–Figure 4.19.

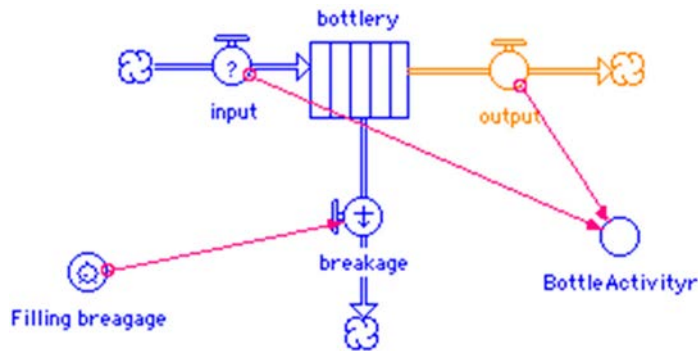

Figure 4.21. The STELLA model for the bottling machine. The model in the STELLA system.

Go to STELLA. Armed with the flow charts and the CLD, construct the model. Start with just the bottling machine using the conveyer function as it is similar to how the machine works although the stock function is also an option for the first run. After the bottles move through the machine on the conveyer belt (Figure 4.21), add the bottle washing machine (Figure 4.22). The bottler is run at the rate the washing machine can feed it. Again, test this sub-model before moving to the next step. That is, test whether the bottles can run through the washing machine into the bottling machine. If it works, move on.

The pulse is used to enter inputs as discrete events. Drop a certain volume into the juice tank when the harvest is made. Everything is just poured into the tank. Explore what the pulse does and how it is defined (an amount to drop in, the time for the first occurrence, and the next point in time when it should be repeated).

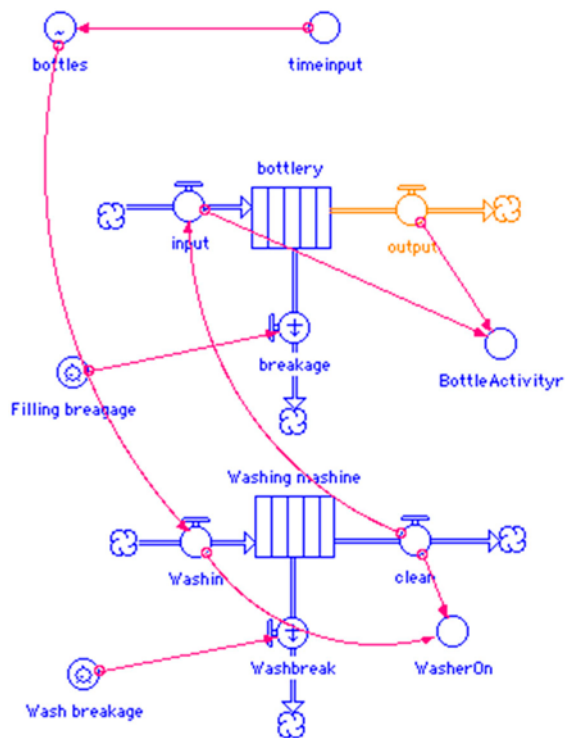

Figure 4.22. Adding in the washing machine. The model in the STELLA system.

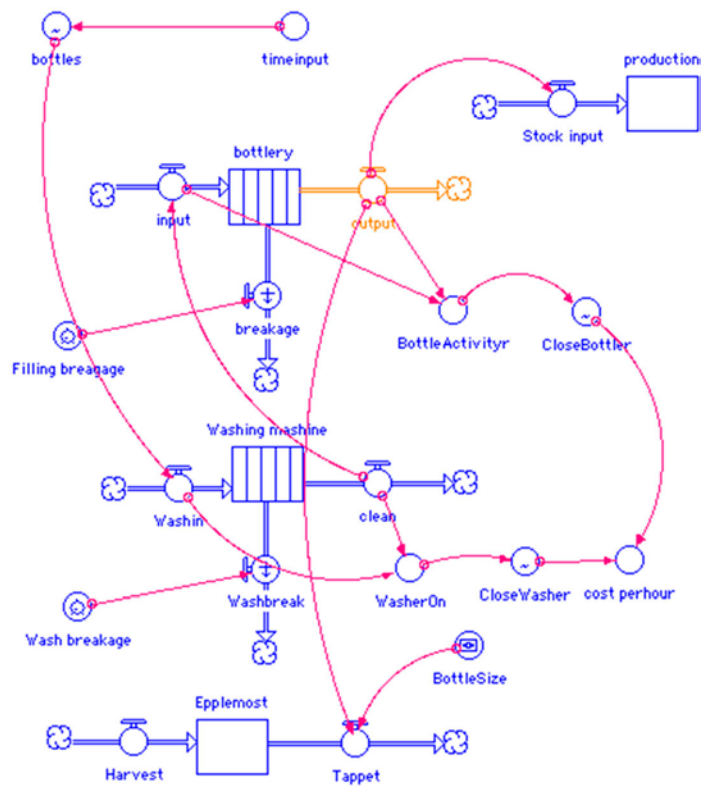

Figure 4.23. Adding in the juice tank and the stock of products. The model in the STELLA system.

This experimentation using pulse will help determine the optimum rate the bottles can move from the washer to the bottler and the total number of bottles the system can move from the washer to the bottler for a given unit of time (e.g., minutes, hours, days, etc.). Now, determine how fast the juice flows from the tank into a bottle (Figure 4.23) and calculate how fast the system moves all the contents in the tank into bottles (Figure 4.24). Run the model and test it.

Finally, using the flow chart and the CLD map of the systems, add the economics of the apple orchard (Figure 4.24). The model should run exactly according to the drawings; if not, then the drawings must immediately be revised. If not revised immediately, a mess will most certainly follow. Once revised, tested, and deemed suitable, pin the diagrams to the desktop as the model is now ready to be used.

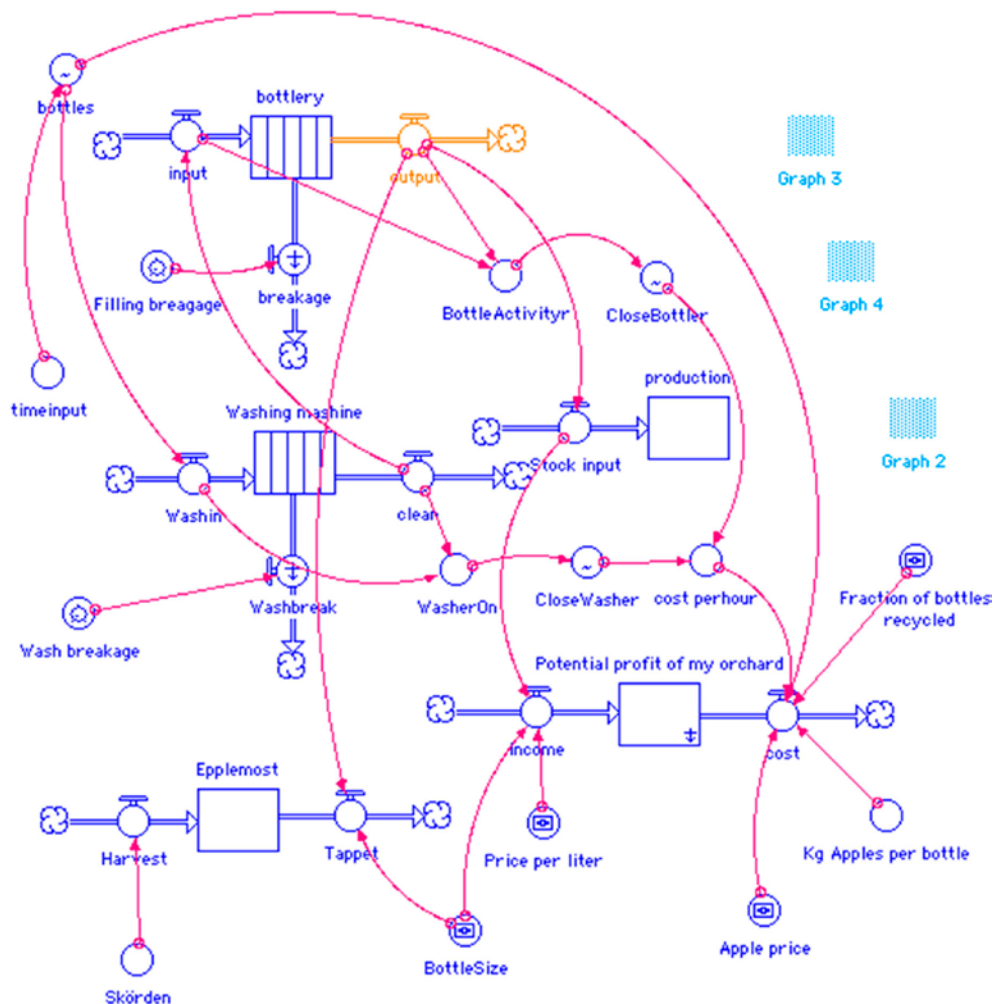

Figure 4.24. The final model for the apple orchard. The model in the STELLA system.

Remember, build the model in a step-wise fashion: Change one variable at a time and test the variable before making any other changes. This step-wise approach will help identify errors or mistakes. Changing several variables simultaneously will inevitably cause problems.

Looking inside the model. Although the STELLA system has an equation layer, this layer is typically ignored. However, a user can find all the equations used by STELLA if there is a need to understand the maths that produce the figures. That is, STELLA translates the equations into a graphical language, the diagrams. Below is a list of equations the STELLA model uses.

```

bottlery(t) = bottlery(t - dt) + (input - output - breakage) * dt
INIT bottlery = 0
    TRANSIT TIME = 5
    INFLOW LIMIT = ∞
    CAPACITY = ∞
input = clean
output = CONVEYOR OUTFLOW
breakage = LEAKAGE OUTFLOW
    LEAKAGE FRACTION = Filling_breagage
    NO-LEAK ZONE = 0
Epplemost(t) = Epplemost(t - dt) + (- Tappet) * dt
INIT Epplemost = Skörden
Tappet = output*BottleSize
Potential_profit_of_my_orchard(t) = Potential_profit_of_my_orchard(t -
dt) + (income - cost) * dt
INIT Potential_profit_of_my_orchard = 10,000
income = Stock_input*BottleSize*Price_per_liter
cost = cost_perhour+(1-Fraction_of_bottles_
recycled)*bottles*0.5+Fraction_of_bottles_recycled*
0.25*bottles+bottles*Apple_price*Kg_Apples_per_bottle
production(t) = production(t - dt) + (Stock_input) * dt
INIT production = 0
Stock_input = output
Washing_mashine(t) = Washing_mashine(t - dt) + (Washin - clean -
Washbreak) * dt
INIT Washing_mashine = 0
    TRANSIT TIME = 20
    INFLOW LIMIT = ∞
    CAPACITY = ∞
Washin = bottles
clean = CONVEYOR OUTFLOW
Washbreak = LEAKAGE OUTFLOW
    LEAKAGE FRACTION = Wash_breakage
    NO-LEAK ZONE = 0
Apple_price = 2

```

```
BottleActivityr = max(input,output)
BottleSize = 0.7
cost_perhour = 20/60*CloseWasher+CloseBottler*10/60
Filling_breagage = 0.04
Fraction_of_bottles_recycled = 0.3
Kg_Apples_per_bottle = 1
Price_per_liter = 12
Skörden = 11,100
timeinput = TIME
WasherOn = max(clean,Washin)
Wash_breakage = 0.02
bottles = GRAPH(timeinput)
(0.00, 10.0), (30.0, 10.0), (60.0, 50.0), (90.0, 50.0), (120, 50.0), (150, 50.0),
(180, 50.0), (210, 50.0), (240, 50.0), (270, 0.00), (300, 0.00)
CloseBottler = GRAPH(BottleActivityr)
(-100, 0.00), (-80.0, 0.00), (-60.0, 0.00), (-40.0, 0.00), (-20.0, 0.00), (0.00,
0.00), (20.0, 1.00), (40.0, 1.00), (60.0, 1.00), (80.0, 1.00), (100, 1.00)
CloseWasher = GRAPH(WasherOn)
(-100, 0.00), (-80.0, 0.00), (-60.0, 0.00), (-40.0, 0.00), (-20.0, 0.00), (0.00,
0.00), (20.0, 1.00), (40.0, 1.00), (60.0, 1.00), (80.0, 1.00), (100, 1.00)
```

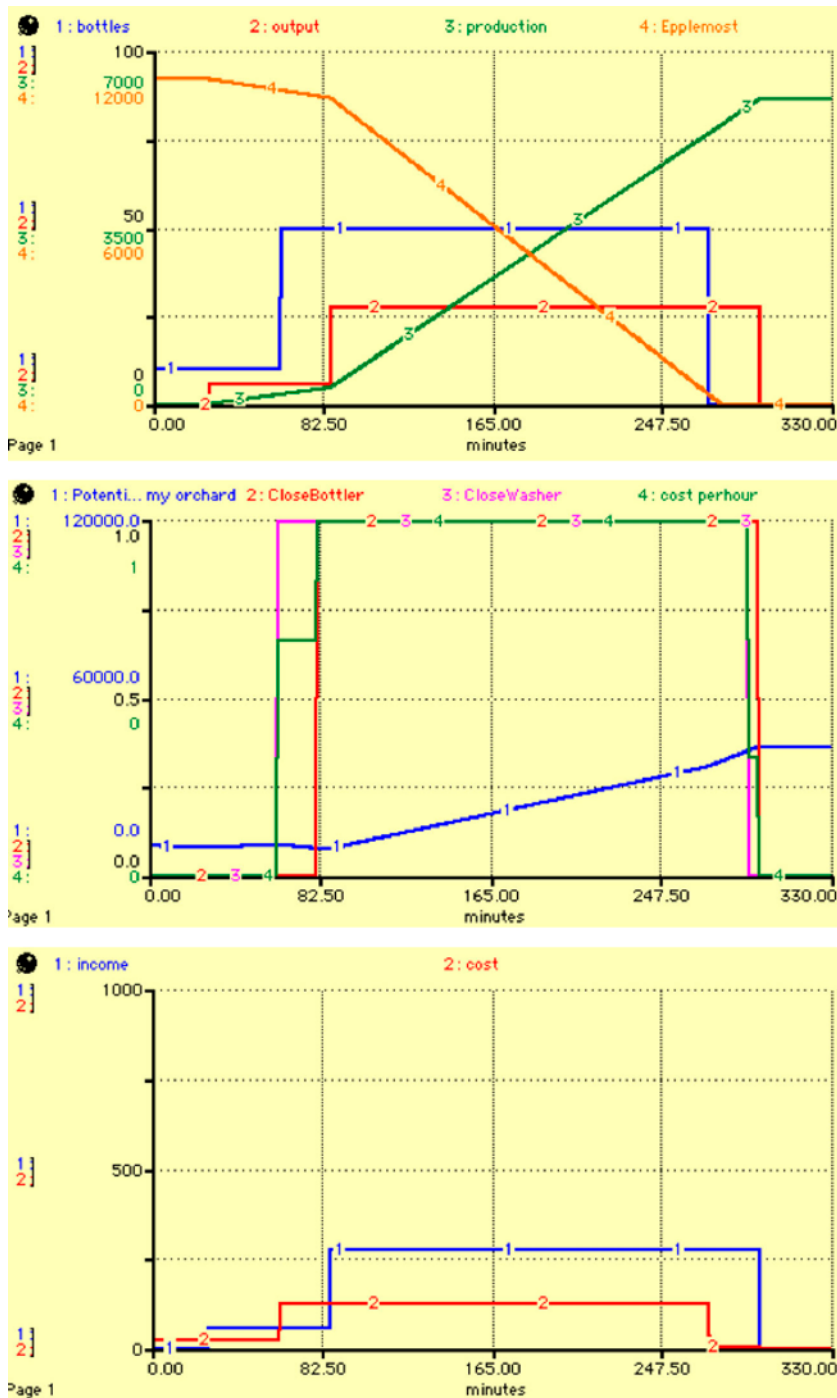
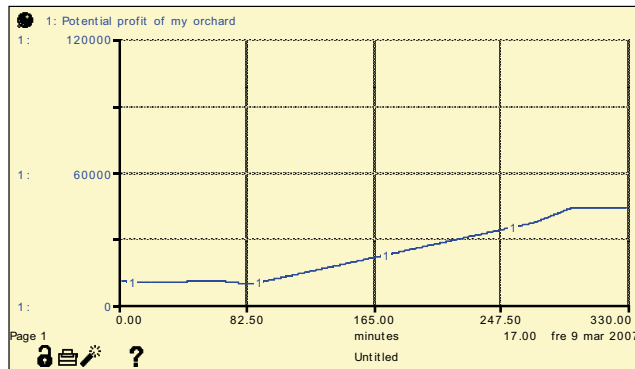

Figure 4.25. Example outputs from the apple orchard model.

Figure 4.25 shows examples of the outputs from the model. Specifically, Figure 4.25 shows how the machine turns on and off, how the juice flows from the tank into the bottles, the number of bottles reused, the number of bottles sold, and the money earned. That is, the whole production process is modelled.

Figure 4.26 shows the control panel for the model, the upper level in the STELLA software, where the essential parameters for the apple orchard and

juice factory are controlled. Ultimately, the control panel is used to determine whether the apple juice production is a hobby or a profitable business, the original question. If it is not profitable, what changes would be needed to make it so? That is, the control panel is simple user interface that allows anyone to use the model by simply changing input variables.



Red were were the apples of my childhood

I inherited the apple orchard from my father, old Sören Äppelquist. Now, I run it and there is a lot of apples every year. In the fall I press them to make my genuine Haväng Epplemost, I put it in bottles and sell it in the Kivik's market. Each 1 liter bottle I sell for about 12 kronor, omitting the middle hands. The empty bottles, I partly buy new for 0.5 kronor, and partly I get the old ones back from the customers (about 30% last year) at 0.25 kronor per bottle.

The mashines I use are old, but I use them still. However, they are simple and have crude mechanics, so 2% of the bottles break in the washer and 4% in the bottling (filling, labeling and corking) mashine. The transit time in the washer is 20 minutes, and in the bottling mashine 5 minutes.

Before being able to press the apples I have to pick them, to press them and filter the juice. I get about 11,000 liters of juice, that is approximately the juice of 20 tons of apples. Picking of apples takes about two weeks, the pressing and filtering two days, the bottling one day, packaging for transport and in the stock two days, and selling them about two weeks. All in all, about 5 weeks of work it takes.

It costs me 20 kronor/hour to run the washer and 20 kronor/hour to turn on the bottler. I can run the mashines for 5 hours in a day.

What kind of profit does this bring me ? How much cash do I need to have all the bottles I need upfront ? Is this something I can live from, or is it just a hobby that covers its

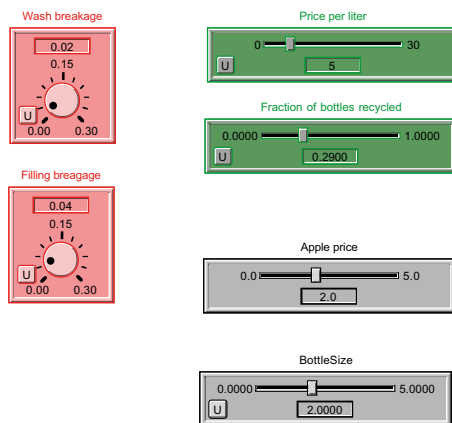

Figure 4.26. The control panel built for the model.

Exercise: Build this model and make an operation model. Use the model to investigate the business case of Äppelquist Apple Juice Enterprises AB. Answer the questions posed in the above discussion.

4.3 The lonely planet: Easter Island

Although several crude Easter Island models can be found in the literature, few address the issue using systems approach and system dynamic modelling. The Easter Island example couples a model from the physical world (trees, boats, statues, food, and people) with a model from the social world (religion, politics, human behaviour, and warfare). Human history seems to repeat itself, although in new contexts. Nonetheless, events seem to be driven by the same forces and rules, an assumption that is both necessary and important for the understanding what happened on Easter Island³.



Figure 4.27. : It has been hypothesised that these statues were erected to display prestige, power, and religious influence of a family clan. More than 1,000 statues were erected over 600 years.

The statues on Easter Island might first appear to be the result of events unrelated to the modern world. However, this is an example of what can happen in any place where resources and space are limited. Earth as whole is very much like Easter Island. Perhaps, we moderns can learn from their mistakes. From its beginning in 350 AD to the first visit by outsiders in 1722, Easter Island was an isolated place. The closest inhabited land is more than 3,200 km away. The first human visitors to the island, perhaps the sculptors of the statues, might have been trapped as the prevailing winds and ocean currents would have made it difficult to return home.

The story. The history of Easter Island is a fascinating and full of dramatic events, spanning at least 1,600 years. The earliest settlers to Easter Island probably arrived around 300 AD. In Easter Island Polynesian, the island is

³ https://en.wikipedia.org/wiki/Easter_Island

called *Rapanui*– ‘the navel of the world’. In Easter Island oral tradition, an heroic founder, Hotu Matua, and his family fled in large canoes after having being defeated in war, eventually landing on Easter Island. They probably came from the Marquesas Islands, 4,100 km away. It is also possible that an additional expedition of colonizers (Polynesians or South Americans, depending on which anthropologist you ask) reached the island at around 1000 AD. Old legends consistently claim that there were two ethnic groups on the island. The purpose of Thor Heyerdahl’s famous Kon Tiki expedition in 1948 was to show that South Americans had the technological skill to go to Easter Island irrespective of whether such a voyage actually took place.

These new inhabitants prospered on the island during the first centuries, and their population grew steadily. By 1000 AD, the large statues, Moai, were set on platforms called Ahu in a ceremonial practice. The Moai probably symbolise power used by competing family lineages and chieftains competing for control over the island’s natural resources. Archaeologists call this period of cultural flourishing the Ahu Moai phase and think it lasted from 1000 AD to 1500 AD. The society remained a stone age society, but the construction design of the Ahu shows sophisticated astronomical alignments. A single statue weighs 10 to more than 50 tons and include a red hair line made from tuff, rock made of volcanic ash. The population lived in huts from the palm trees, fished from canoes, harpooned porpoises, and cultivated traditional Polynesian crops, mainly potatoes. Large seagoing canoes were used to fish in deep water where the porpoises and small whales live. Both farming and fishing required tools such as canoes made from large trees. The only domesticated animal was chicken. The land was “owned” by the extended family that cultivated it, as is the custom in a traditional clan societies. The Easter Island civilisation also developed a writing system – 21 tablets of this writing system are in museums across the world. The writing system is a mixture of logographic and alpha-syllabic writing called *Rongorongo*, which consists of almost 200 signs, but only 120 are used frequently. The texts are long, but they have not been translated although linguists have been able to show that the script is largely phonetic and has a grammar. The existence of the tablets was first recorded in 1851, and in 1868 a missionary reported that he had seen hundreds of tablets on the island and in every house. However, the first sample of alpha-syllabic signs are from 1770. Some people think that the script is a new invention, a mimicry of European writing. However, it is highly unlikely that the islanders invented the script as late as 1770, during some of their worst wars, and had forgotten it all by 1864. The tablets reveal a complex structure that would have required some time to develop. Legends tell of a text that goes back far in time.

From about 1500 AD, the island's culture seems to have entered into a phase of decline. In 1675, a civil war broke out on Easter Island, halting the construction of monuments. Many statues lie half-finished in a quarry. This phase was marked by perpetual war that lasted to the date of the first contact with Europeans in 1722. Roggenveen, a Dutch captain, records that the inhabitants showed scars and wounds from violent actions. He estimates their total number to be several hundred, maybe a thousand. In 1770, the statues were recorded as being still upright. During his visit to the island in 1774, James Cook found that the statue cult had disappeared and most of the estimated 1,000 Moai had been toppled. In 1826, the population was estimated to be 700 and in 1850, 1,500.

After 1820, the islanders suffered from their contacts with Europeans. The Europeans brought measles and smallpox and this decimated the population severely. In 1862, pirates from Peru took 1,000 islanders (almost half the population) and in 1877 only 111 remained. In 1888, the island became a part of Chile, and remains so to this day. The archaeological evidence suggests that Easter Island underwent environmental degradation, paralleled by an increase in warfare and religious fervour. The initial population that colonised the island in 300 AD is estimated to have been between 50 and 200 people. Archaeological surveys suggest that this number rose steadily until 1100–1400 AD, and around 1600 between 7,000 and 10,000 people could have lived on the island.

The decline is marked by the toppling of the statues, perhaps as a way to symbolise a change in prestige, power, and claim to resources. The final phase of the collapse was probably induced by deforestation of the nut palm and toromiro forest and increased competition for diminishing resources. Palm trees were important sources of fibre and food, and toromiro wood was important for shelter, tool, and boat construction.

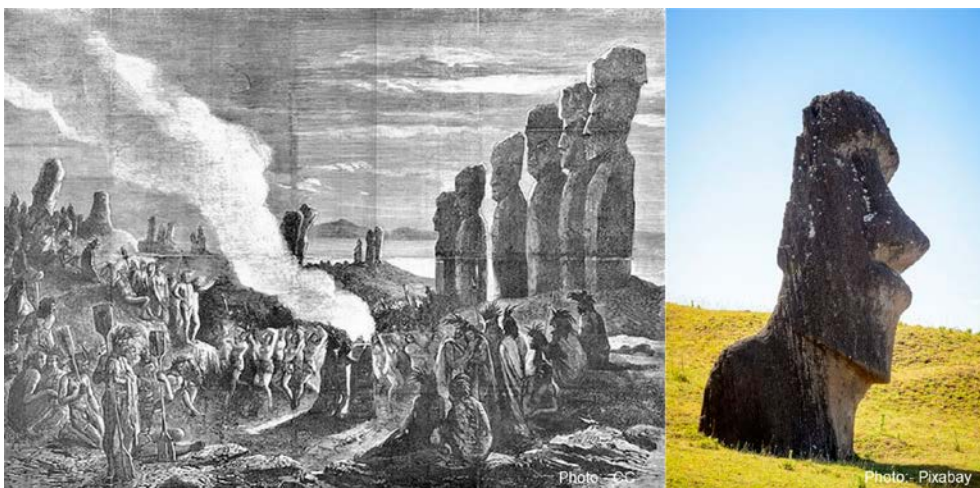

Figure 4.28. Towards the end of their civilization, the inhabitants of Easter Island broke normal social taboos and became cannibals. Cannibalism became an instrument of oppression and terror. Victims, usually women or children, were used as sacrifices to the gods, the symbols of power. They were devoured in cannibalistic rites. Incipient civilization was converted into grim barbary. Many of the Moai still stand, and several have been re-erected.

Paper mulberry trees provided fibre for cloth, rope, and fishing nets. And all the trees were important sources of fuel. Many large pieces of timber were also necessary for transporting and erecting the large statues. The deforestation led to severe soil erosion, reducing the area and quality of land for cultivation, upsetting the water balance of the soil, ultimately resulting in crop failure. Without large trees to make canoes, travel at sea became impossible, and offshore fishing impossible when all canoes had fallen into disrepair without the possibility of being repaired or replaced. The lack of trees also caused the standard of housing to deteriorate significantly. During this phase, the religious cult of the birdman took hold; birdman was believed to have supernatural powers that would be used to deliver the people from the woes of the world. During this time, they also became cannibals, invented cruel religious acts, and became more aggressive. The society on Easter Island was rapidly disintegrating.

The pollen record shows that forests started to decrease between 900 and 1000 AD, and the last large trees must have been cut down between 1400 and 1500 AD. Single tree plants still continued to exist in small numbers inside the volcanic craters, but for all economic or practical purposes, the forest was gone for good.

Once the forest was gone, the wind conditions changed significantly and the conditions for self-rejuvenation of the forest became much poorer. The people who arrived in 1000 AD probably brought with them the Polynesian rat, an animal that prevents the coconut palm from self-seeding as it eats fallen coconuts. Therefore, active planting is necessary. Miraculously, the toromiro tree has survived. The last tree's seeds were rescued by Heyerdahl in 1949 and planted up in the botanical gardens in Göteborg. The position of the last tree on the sides of the mountain of Rani Aroi was such that the man who cut down the very last tree could see that it was the last tree on the island, yet he still cut it down.

Apparently, the islanders ran out of forest 250 years before the population collapsed. In 1675, the civilization crashed finally in the war of the "Short ears and the long ears". The "long ears" probably referred to the aristocracy, and the "short ears" the powerless and possibly landless commoners. Easter Island language and culture is Polynesian, and the genetic evidence suggests that the bulk of the population must have come from central Polynesia.

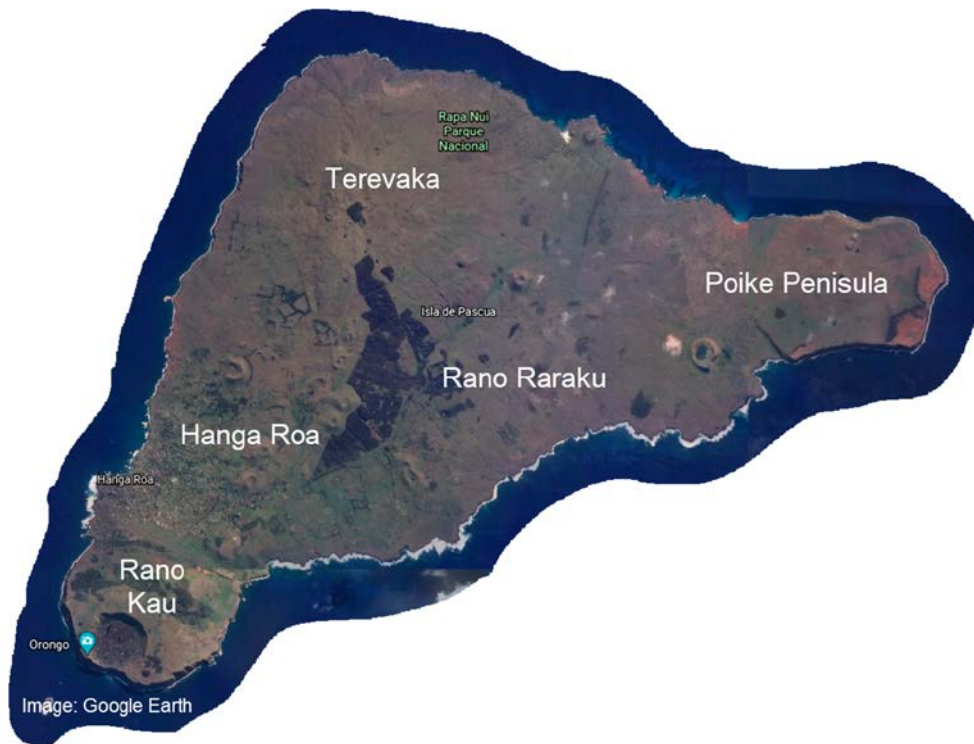

Figure 4.29. The island measures 22km x 15km and is approximately 160 km². The three corners reach the elevation of approximately 500 m. The soil is of recent volcanic origin. Water is available in three crater lakes; the island has no surface streams. The climate is moist. The present population is approximately 2,500. In 1675, the last battle took place, on the Poike peninsula where a large ditch had been dug across the isthmus (Image: NASA Earth Observatory).

The language once contained many archaisms and several elements that cannot be explained using Polynesian etymologies. Additional immigration from South America (if it occurred) was probably too small to have left any significant genetic trace, although visitors from South America may have brought potatoes and affected on the language. It is an undisputable fact that the sweet potato, cultivated widely throughout Polynesia, originated in South America. Thus, either the Polynesians reached South America or the Indians of South America reached some Polynesian islands. It is possible that this exchange happened much earlier, to the north, in the Marquesas Islands, and that the potato came to Easter Island from there. Either the Polynesians picked up the potato from South America or South Americans took the potato to Easter Island.

However, their problems were not over. In 1800, slavers from Peru abducted 1,000 inhabitants, about 50% of the population.

The issue. The people on Easter Island landed on a fertile, uninhabited island, covered in dense forest. What really took place on the island between 300 AD and 1800 AD? We need to construct a model for the sustainability potential of Easter Island and predict its demographic and economic development to understand what happened and why it happened. Is it possible to estimate how large the population really grew on the island and explain when and

why their civilization crashed? Could they have avoided their final collapse ?
What should they have done to avoid their collapse? Is it possible to predict
this from understanding the system without telling the model what to do ?



Figure 4.30. Easter Island at Anakena Bay.

A back-of-the-envelope estimation can connect the food and the number of boats available as boats would have lasted past after the last tree was harvested, but once the boats were unrepairable, food harvests from the ocean would have declined rapidly. We assume that a large Polynesian seagoing canoe would last approximately 30 to 35 years, and approximately 3% of the canoes are lost at sea or worn out every year. The Eastern Islanders, we assume, harvested approximately 0.04 trees per person per year for food and other subsistence purposes until the last tree is gone. There is no real feedback until the very last trees have been cut down. There appears not to have been any limitation to harvest as long as a tree was alive. The lack of food slowly increased the death rate from the normal 2% annually at 200 persons per boat to 4% as each boat had to support more people, well above 200. At 600 persons per boat, death rate increased to 4% and remained at that level. The boat building rate is proportional to the population's need for food, and presumably the population attempted to build enough boats to keep hunger away.

Assume that each boat requires three to four large toromiro trees. The monuments they erected, weighing as much as 35 tons, were moved with logs, manpower, and large timbers. Some data are available for model validation: number of monuments (approximately 1,000 were built); the maximum population size (roughly 10,000), and the time of disaster (1572). These data can be used to evaluate the performance of the model and address the uncertainties involved.

Demonstrating of how to solve the problem. First, we searched for information on the internet, including the Easter Island home page, which includes several articles and several very simple models about Easter Island's history, although these articles and models are insufficient for our purposes. Next, we went to the university library where we found several books about the Easter Island

collapse: *Aku-Aku* by Thor Heyerdahl (1953); *Easter Island Earth Island* by Bahn and Flenley (1997); and *Collapse* by Jared Diamond (2000). We developed the following strategy and work plan.

1. Identify the system's parts and the connections

What are the system's components and boundaries?

How can we simplify the problem so to involve only the necessary sub-systems?

2. Analyse the system's properties

How would limited resource supply result in conflict?

What were the mechanisms of increased competition when resources became restricted?

3. Draw a CLD of resources use, people, water, agriculture, and rituals.

4. Assume certain system properties

Assume that the island had a stable population of full grown mature trees (30% toromiro tree, 45% juba palm trees, and 25% coconut trees) when the first settlers arrived. This represents the steady state forest cover on the island. There are many other trees and bushes as well, good for firewood, but not good for moving monuments and building boats.

How many trees were on the island when it was untouched by humans?

Assume the first settlers were 60 people arriving in three boats 400 AD.

Assume that each couple had about five children who lived to reproduce, and 50% of the population was of fertile age. An unlimited population will initially grow at 3% per year, which falls to approximately 0.6% in very crowded societies (Table 4.1).

Assume the average life expectancy is 45 years.

Assume that the islanders did not replant cut down trees but relied on natural rejuvenation.

5. Construct a model

Design conceptual model

Build a STELLA model that includes population, number of boats, number of trees, and the political/religious system.

Parameterise using information from the internet, assume reasonable values.

Question the structure: Was every part necessary? Which parts can we do without ?

Investigate the system by performing experiments using the model.

Table 4.1. Connection between forest regeneration and number of mature trees on Easter Island. Lack of space prevents regeneration. The above numbers include the understory vegetation. In a managed forest with uniform tree composition, the area is full when there are 1,500 trees per hectare; for smaller trees, the number is considerably larger.

Forest Regeneration rate	Mature trees on Easter Island
4.5	100
4.4	5,000
3.9	10,000
2.7	15,000
1.2	20,000
0.5	25,000

From this, identify the important components in the system:

Number of people

Number of boats

Statues as a representation of religion

Trees available for construction (toromiro) and food and fuel (palms and other)

Food available

Degree of social stresses

From this information, we create a CLD (Figure 4.31). As it is a simple CLD, there is not much room for other factors and actions.

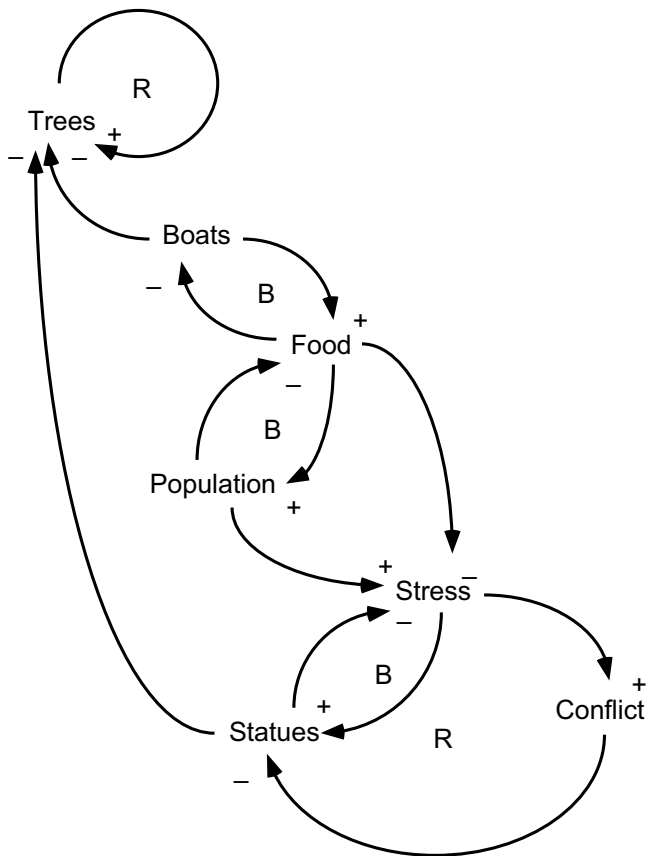

Figure 4.31. The first CLD for the Easter Island problem.

The trees regenerate, and in absence of cutting, they would grow forever. However, it is not known what makes them grow. We need to ask why. The islanders exerted extensive effort and resources to build and move the statues. Why are stresses relieved by statues? So, we need to add some actions. We will try with the following list:

- Tree cutting
- Fishing for food
- Statue building
- Boat building
- Warfare and violent conflict
- Population proliferation
- Population mortality

One of the first things to do would be to arrange these in a CLD. What controls these actions?:

Boat building is promoted by less food per person and is prevented by lack of trees.

Boat building increases the number of boats and decreases the wear and tear on already built boats.

Food is collected in the forest and sea and crops are cultivated.

Food is decreased by people eating.

Stress is increased by too little food per person. Decreased by collective social actions. Increased by high taxation, such as building heavy statues.

Conflict is created when the stress reaches a threshold.

Statues are increased by building and decreased during conflicts.

The CLD in Figure 4.31 reveals that we need a better indicator or parameter relating food to stress. That is, more people require more food irrespective of the food supply. So what counts must be food per person and not total amount of food. That is, the new parameter in the system should be food per person. Conflict also affects the population. Warfare decreases the population, so a link is missing in our diagram. Why are new boats built? Because there are trees? No, trees will only control when a boat cannot be built. So, we must ask, what is the purpose of a boat? Why invest effort into building a boat? What makes it worth the effort? Two reasons – food and prestige. However, the islanders built for the statues for prestige. Therefore, they built the boats to get food. It is reasonable that when there is little food per person, some will build a boat to get more food. So either we go from food per person to explain why boats are built or we go from persons per boat to explain why boats are built. The CLD does not say much on how we want to model the forest.

Furthermore, the CLD does not say much about how we want to model the forest. The forest will self-rejuvenate: more trees, more rejuvenation; more rejuvenation, more trees. The more trees, the more people will die from old age and natural causes. More mortality will reduce the number of trees. Humans increase mortality by harvesting trees. The tree model will focus on number of trees and not size or weight of trees. To make it simple, all trees have the same size. In Figure 4.32, the CLD is just for the trees.

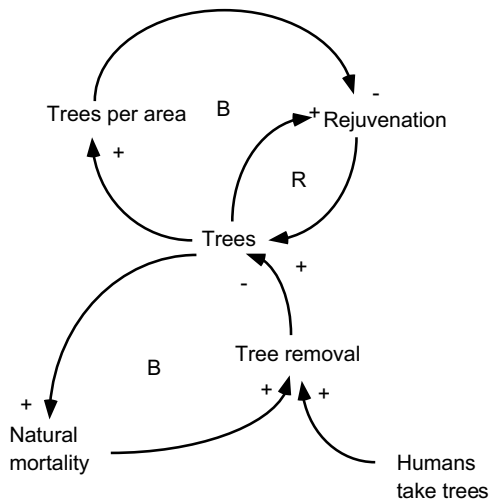

Figure 4.32. The CLD for the forest on Easter Island.

At this point, we decided to build the STELLA model. As always, we start simple. When building the model, first make a simple model for the forest. Why start with the forest? When the humans came, forest covered the whole island. Because the forest was healthy without the humans, the model must include this information. After creating this simple model for general trees, we tested it. We made a first version of this tree model in STELLA, running just the trees, in order to test the forest sub-model. We must be able to model the trees before the humans arrived, as it is a fact that trees covered the island before humans arrived. We can check the performance in the first model output diagram. We also divided the model into two types of trees, which simplified the work (Figure 4.33).

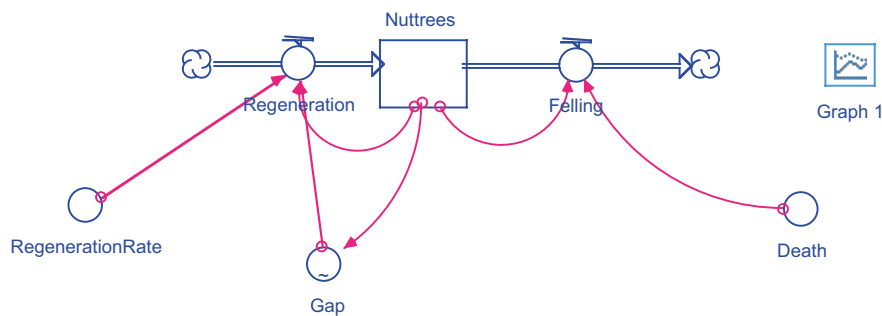

Figure 4.33. The first Easter Island forest model in STELLA for the trees.

Why did we divide the trees into two types (toromiro trees and coconut palms) as is seen in Figure 4.34? We did this without fully questioning the move. This decision is risky as we just went on building without a proper plan. A well-trained modeller might be able to do this, but for a less experienced modeller this move could easily result in a mistake.

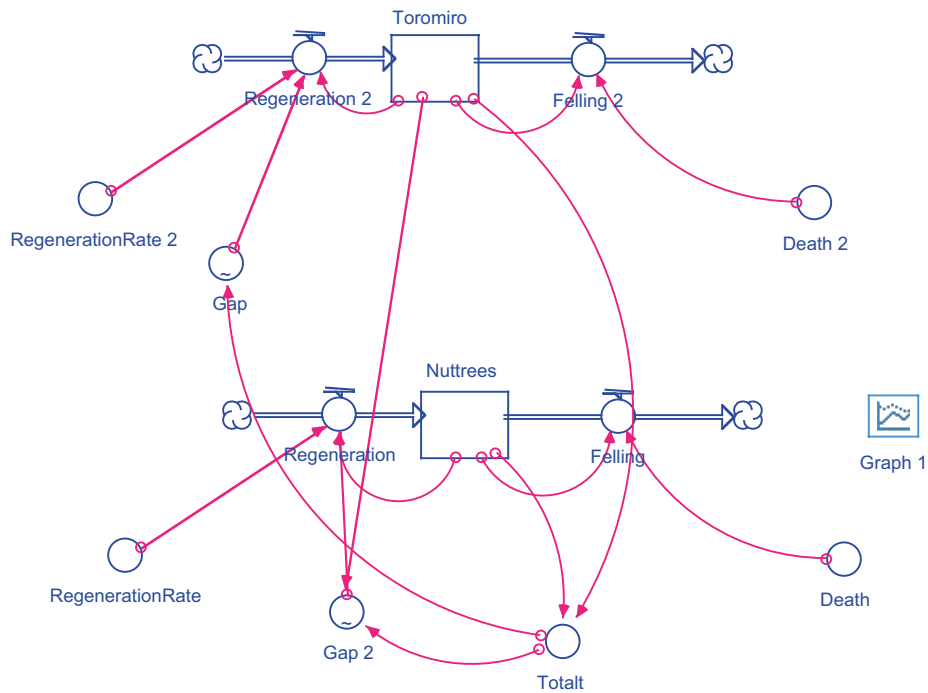

Figure 4.34. The enlarged tree model using two types of trees.

However, up to this point, the model has behaved well, just like the first one, but now with two species of trees. Note how we go forward, step-by-step.

We used the first tree model to make our third model. It has three stocks: boats, population, and trees. Again, we checked how it worked using the graph in Figure 4.35 when running the model as shown in Figure 4.33. Next, we made the first model for the system. Interestingly, the model crashes the population about 1600 with only three stocks in the model (Figure 4.37) and with outputs (Figure 4.39). Let's test the model. As predicted, the trees grew to a certain point, and then stopped growing.

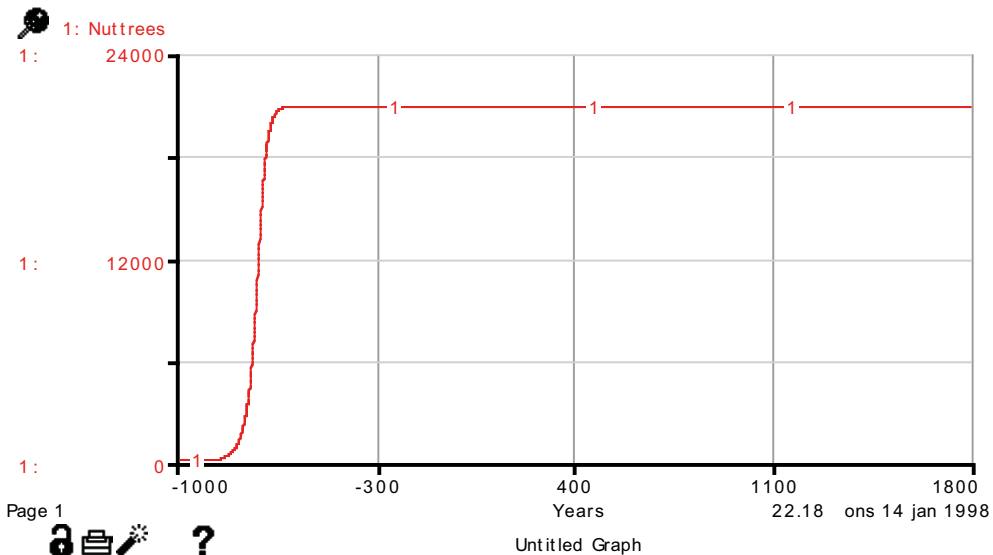
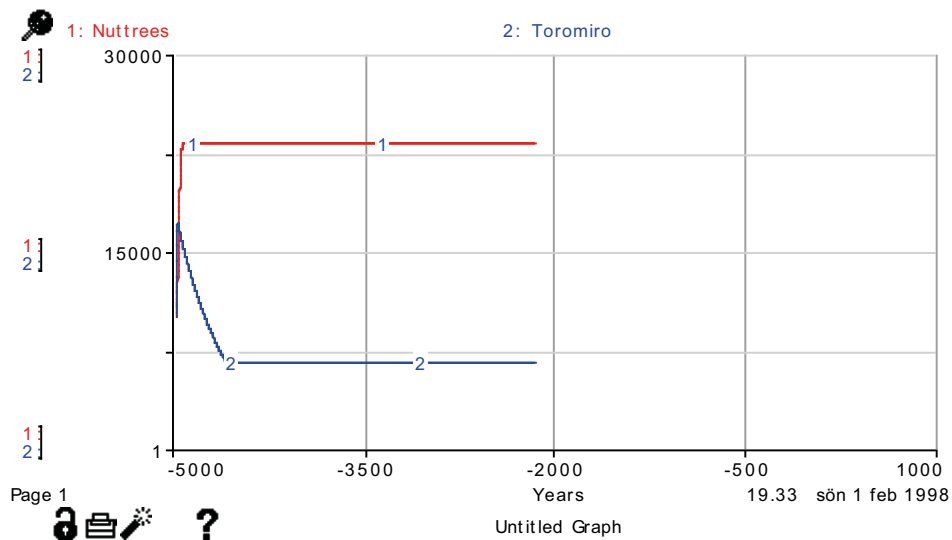

Figure 4.35. Outputs from the first two test models made in STELLA.

Now it is possible to make the next CLD for our problem, boats (Figure 4.36). We made a model for the boats by asking why they were built. Because there is wood available? No, that is not the cause, but it is a prerequisite. Boats are not built just because trees are available. Building an ocean-going boat is hard work, so there has to be a real need. The need is the realisation that boats are the main instrument for getting food, so hunger is the driving factor. That is, the disaster is primarily precipitated by the breakdown of the physical system. When the trees run out, a chain of events runs through the system that spills over into the social system, and eventually the society collapses.

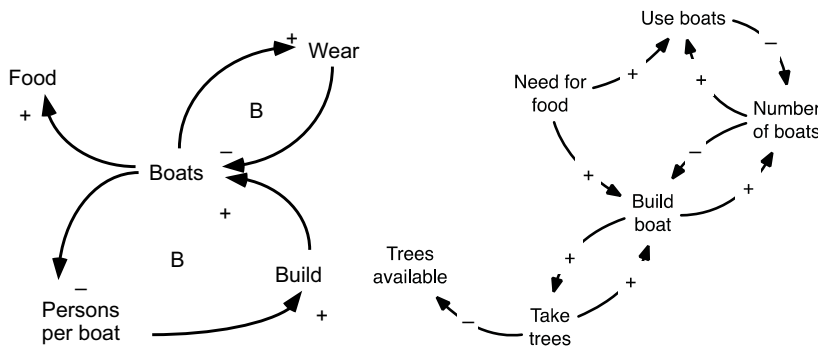

Figure 4.36. Two alternative CLD for the boat system dynamics.

However, the chain of events is not very transparent in the simple model as much of it is baked into the relationship between the people per boat variable and the occurrence of violence variable. We made a separate CLD for the population system. It is fairly conventional, but simple to parameterise since the main parameters are well known (Figure 4.37). We made a separate CLD for the religion and social stress system (Figure 4.40). Here, we can see that stress leads to more religious devotion, an attempt to control emotions in the population. However, the work to erect the statues is a source of stress. Conflict ruins the statues. The religious devotion leads to the construction of statues. However, religion is belief, and when it is part of the promise to resolve problems, then the credibility of the religion is undermined and the effect of religious devotion may disappear. In the physical model, warfare affects the physical the statues; it destroys them.

The social part has two stocks: social stress and religious effect. We really need to build the social sub-model much more explicitly to test whether the variables we have put in really produce the outcome evident in the island's real history (Figure 4.41). Figure 4.41 reveals that the model has four stocks for the physical stage: trees, people, boats, and statues. Several conversions are also needed. How many people per boat is a proxy for food? How boat construction and statue construction leads to tree harvest? How does population mortality depend on the number of people per boat? And several converters are needed: stress to conflict; stress to cannibalism; conflict to stress; heavy construction work to stress; and statue use to stress relief. There are some important feedback loops between the sectors. The construction of statues creates stress as the work is tough.

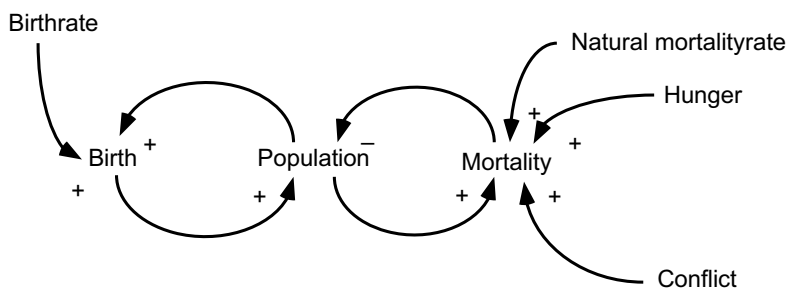

Figure 4.37. CLD for the population system on Easter Island.

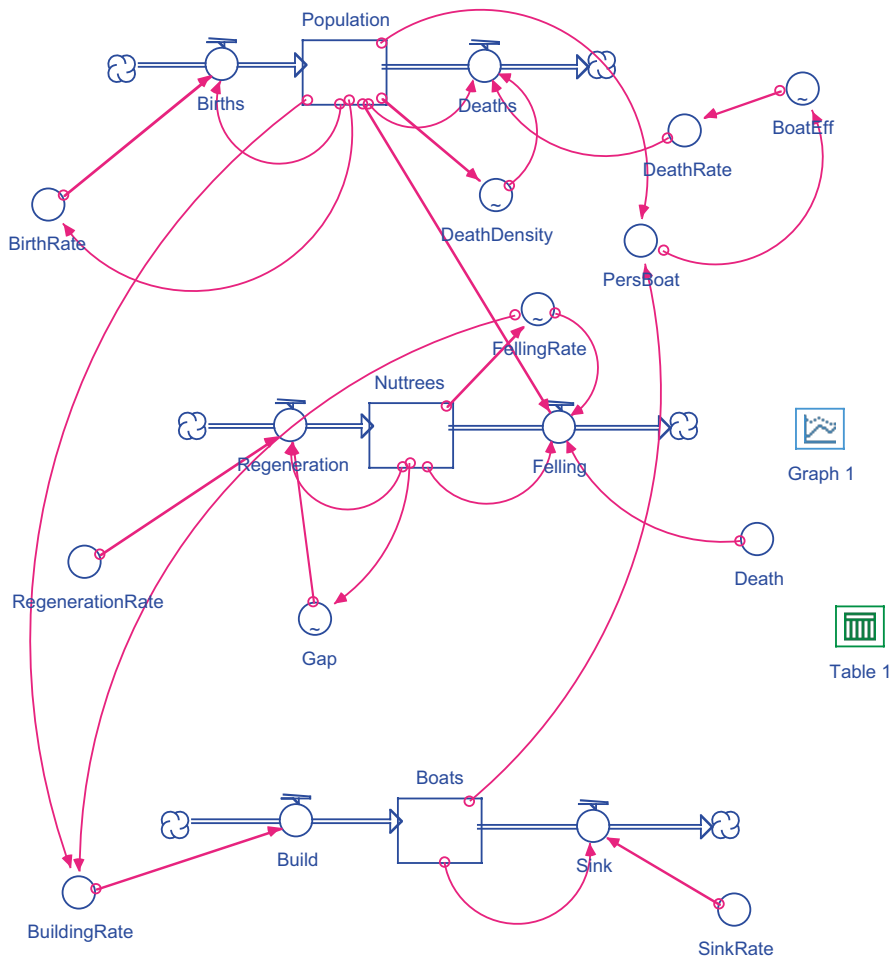

Figure 4.38. The next STELLA model was based on three reservoirs only: forest, people, and boats. This is the simplest model possible.

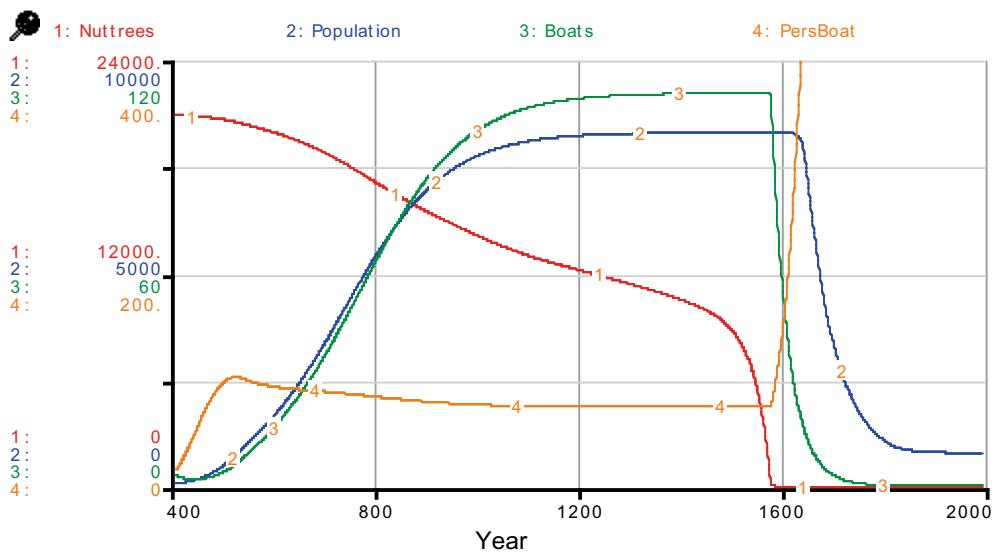

Figure 4.39. First results from the first model for the Easter Island system from 400 to 2000 AD. It does not reflect the whole CLD, but it still shows the basic behaviour. It does not reflect the social system in a very simplified way.

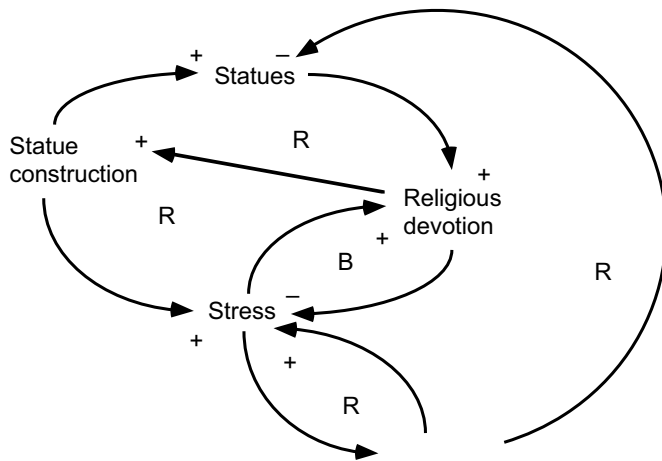

Figure 4.40. CLD of the Easter Island social system before the great disaster.

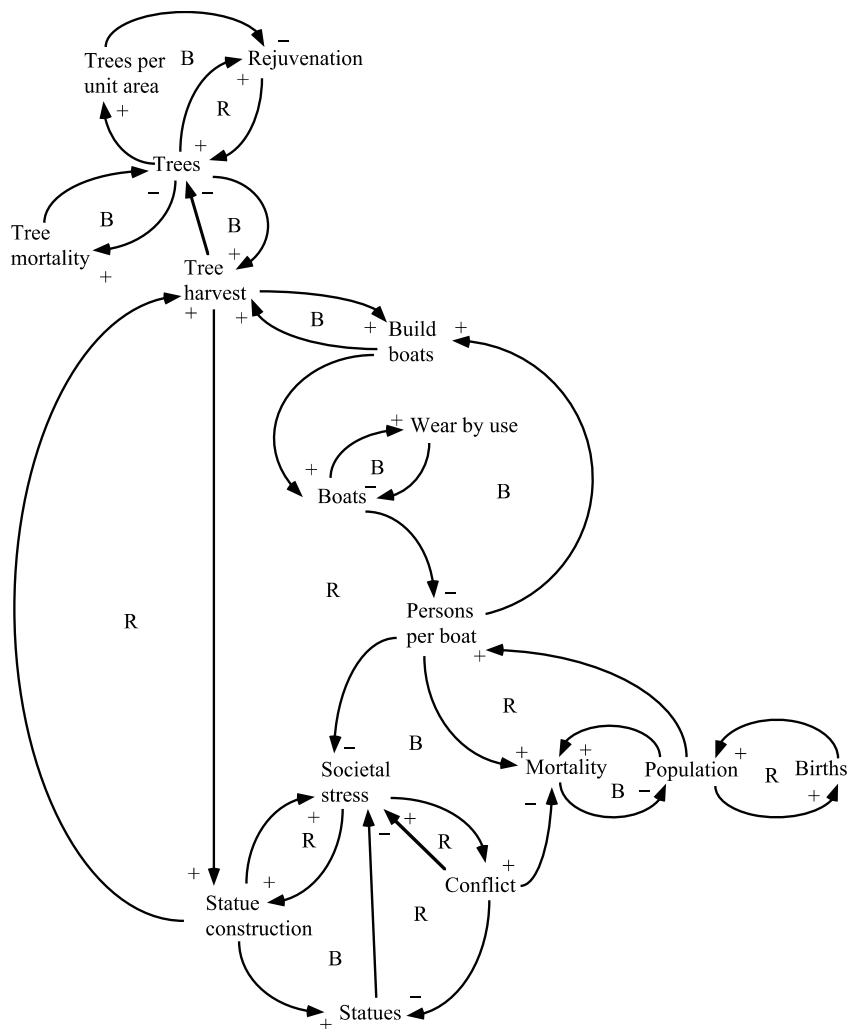

Figure 4.41. The new CLD for the Easter Island problem after revision and inclusion of more elaborate subsystems outlined above.

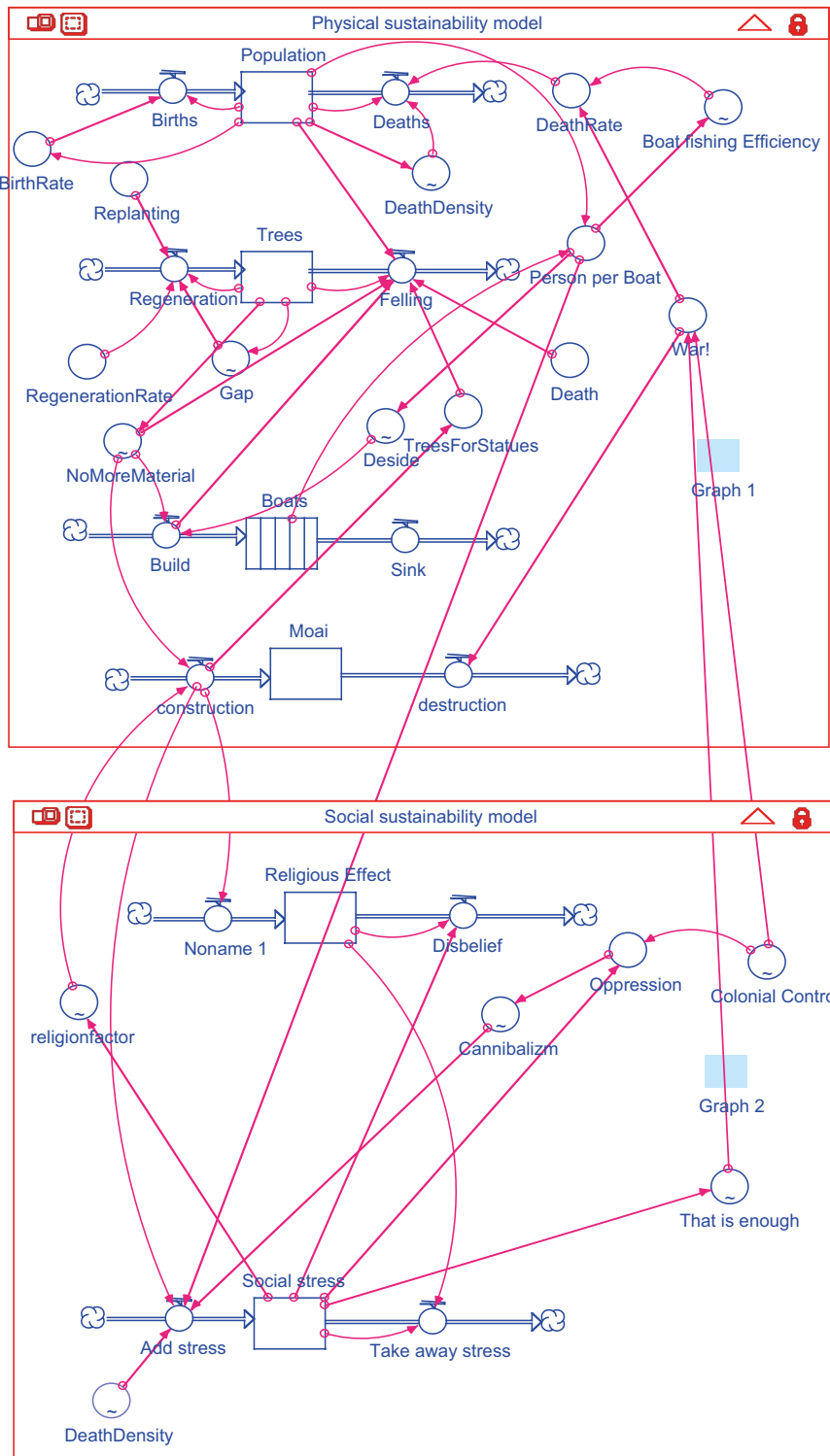

Figure 4.43. The model with the social sector better developed to reflect the social subsystem.

The construction of the statues were intended to have a religious effect that would remove stress in the population and therefore decrease social tension. If this is how we think it really works, then we again need to modify the CLD in Figure 4.41. The revised CLD is shown in Figure 4.42. In the Easter Island system, we have parameters like food, hunger, and food surplus. These are in reality all aspects of some other parameters. Little food per people is hunger; too much food per person is surplus; it is all food, from none to a lot. We chose not to include food as a stock, because the type of food used on the island cannot be stored for extended periods. Rather, food is instant, and as soon as the boats are gone, food will be unavailable above a very low level of land-based food supply.

Model outputs. Outputs from the Easter Island model based on the CLD in Figure 4.42 for the physical aspects if the system are shown in Figure 4.44. The lines show the different indicators of the physical system: red is number of trees, blue is number of people, green is number of boats, and orange is number of people per boat. The system collapses after all the trees have harvested, when the boats wear out, and the food supply collapses. The collapse is predicted to occur about 1560. In reality, the collapse happened in 1572, so the prediction is good.

We predict that the number of statues would decline from a peak number of 900 to about 250 in the period after the great war in 1572. The Europeans found about 1,000 statues on the island of which 180 were still in their original positions. After the collapse, the system remains unstable with high stresses, including small wars and cannibalism.

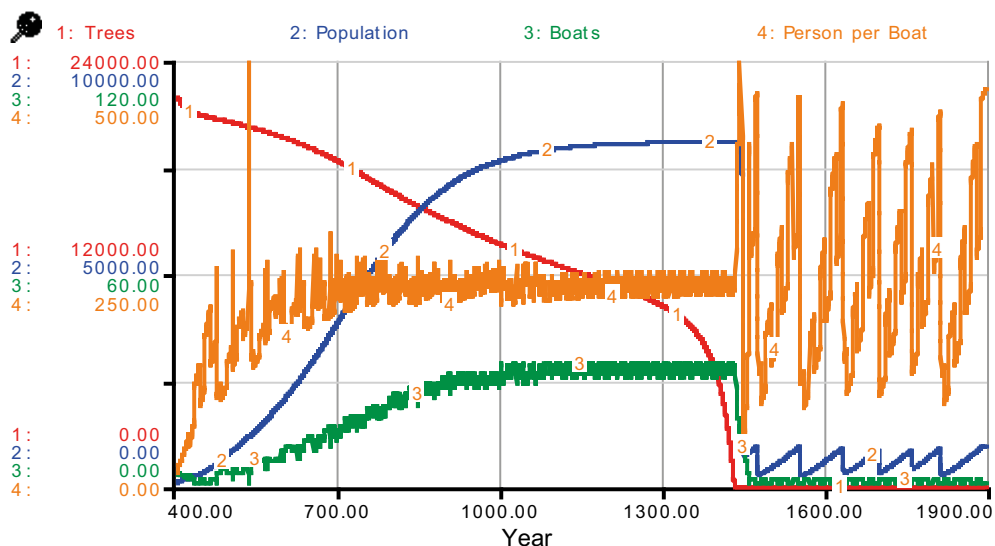

Figure 4.44. Outputs from the Easter Island model based on the CLD in Figure 4.42 for the physical aspects of the system. The lines show the different indicators of the physical system: red = trees; blue = people; green = boats; and orange = people per boat.

Figure 4.45 shows the social indicators. It is always a challenge to make social models, especially for social issues heavily laden with prejudice, preconceived opinions, envy, greed, pride, and group think pressure. Sometimes academic prestige can make modelling difficult as researchers can react not as scientists but as socially competitive creatures. Public stakeholders also can react in similar ways. Unfortunately, model making can expose human vices. Many social and political science departments are paralysed by the competitive nature of academia, inhibiting advancement in their fields. Therefore, a transdisciplinary approach can be helpful as traditional scientists are often very good with details of their fields.

Similarly, group think pressure can inhibit advancements in a particular field of study. Therefore, people from outside a field generally have better possibilities creating a better overview of the SA and formulating the rules of the game than those within the field. Although academics in these disciplines often dismiss these criticisms, the hard field data are compelling. In our social model, it is essential to always question assumptions, explicit or implicit, even if the assumptions are made by experts in the area under scrutiny. People generally have a difficult time recognising their implicit assumptions. To say you do not know is in many situations to say you do not know yourself. This is insufficient. You must endeavour to know. The Ancient Greek aphorism ‘Know thyself’ (γνῶθι σεαυτόν) was inscribed on the pronaos of the Temple of Apollo at Delphi according to Pausanias. However, because of a lack of advancements in scientific building of social models, there is plenty of room for creativity and unconventional solutions as the traditional approaches have produced no success. Performance of the field test is what counts irrespective of protestations.

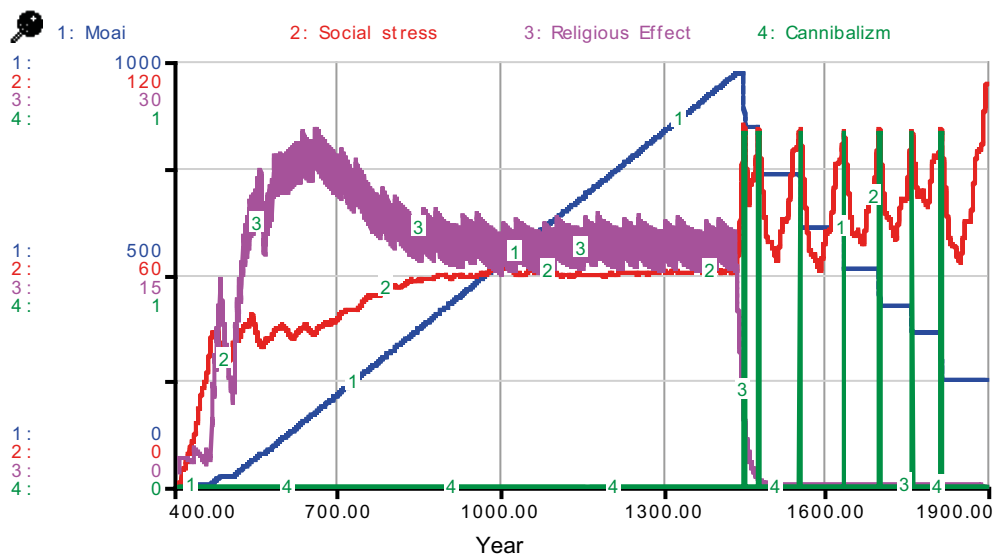

Figure 4.45. Outputs from the Easter Island model based on the CLD in Figure 4.42 for the social aspects of the system

INDICATORS IN THE SYSTEM

In the CLD in Figure 4.46, we have indicated how the causal relationships between some of the system indicators are constructed in this system. Different indicators are needed to interpret the system behaviour that will enable predictions of future events and to diagnose system behaviour with respect to social problems or changes brought about through political measures. We distinguish the indicators for drivers of the system state, for the state of the system, and for what is affected by the measures that change the drivers or the state of the system. We distinguish the following system indicators:

- Indicators for drivers of the system state
- Indicators for the state of the system
- Indicators for the things we affect with measures to change the drivers or the state

Surveillance of the system state requires scrutinising these indicators by monitoring the social stresses and the number of trees. The social output to avoid is violent conflicts, so stress is the most important indicator to monitor. The political measures focus on the system drivers, and these are needed to judge whether the measures were implemented, although the effect of the system drivers is measured by determining the change in state parameters.

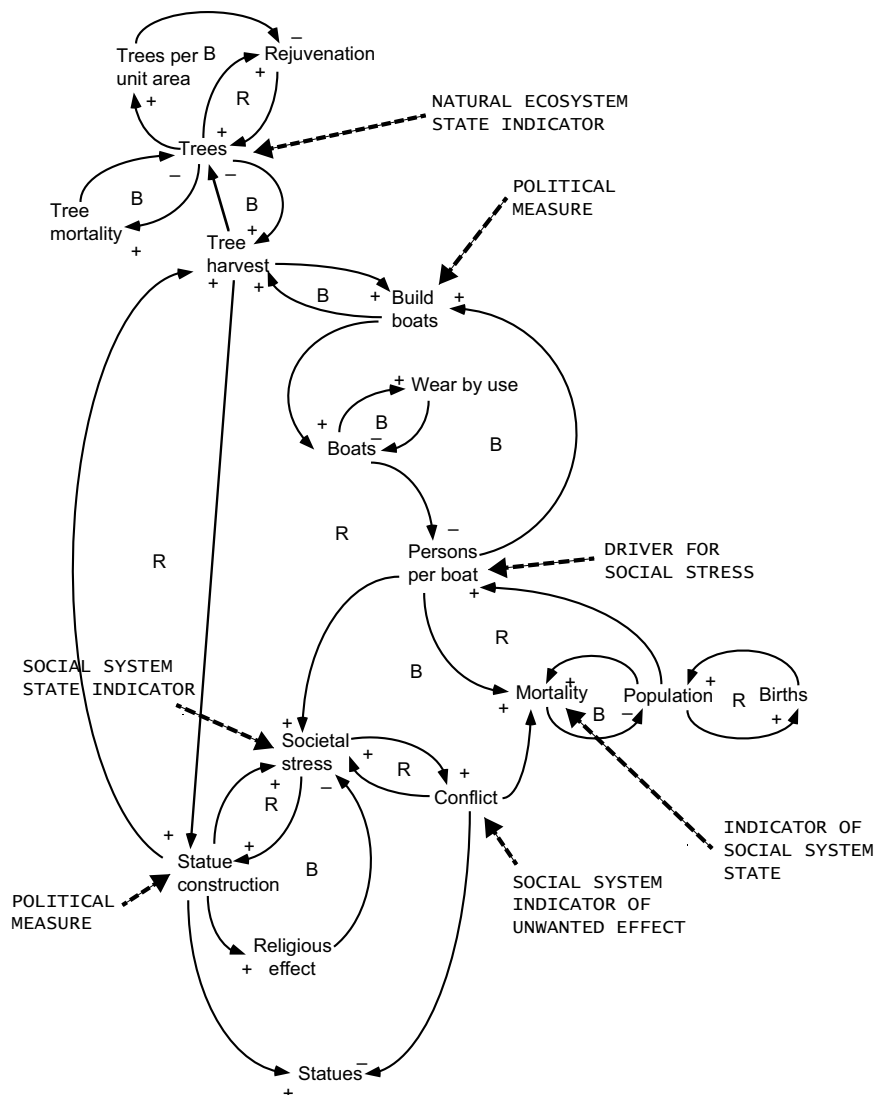

Figure 4.46. Indicator analysis for the Easter Island system. We have indicated how the causal relationships between some of the system indicators behave. Interpreting and diagnosing the system and monitoring changes brought about through political measures requires different indicators: (1) Measures, (2) System State, and (3) State drivers. We have outlined examples of such indicators.

Validation: Do the field test! Validation of the model means that we check the model performance on some of the observed real system outputs. In the case of the Easter Island, we have data we can use. The maximum number of statues (Moai) is known to be approximately a little less than 1,000 of which about 180 were found in their original places after 1800. We also have estimates of the maximum population, between 8,000 and 10,000 people in 1500, an increase from about 60 in 400 AD and decrease of about 1,000 just before the slave raid in 1810. Finally, we know when the disaster occurred, 1572.

We can compare our model outputs to all of these known facts (Figure 4.47). To validate the model we constructed for Easter Island, we can check whether our predictions appear reasonable with respect to the known history. We have

some qualitative observations to make, which is also a part of the validation. We see that after the disaster, there are repeated periods of hunger, leading to stress that culminates in cannibalism. This is predicted as we can see in Figure 4.45, so the model reconstructs this consistently with the actual history. The conclusion is that the model seems to capture the dynamics of the Easter Island well enough that we can trust it to confirm our model as a plausible explanation of what happened.

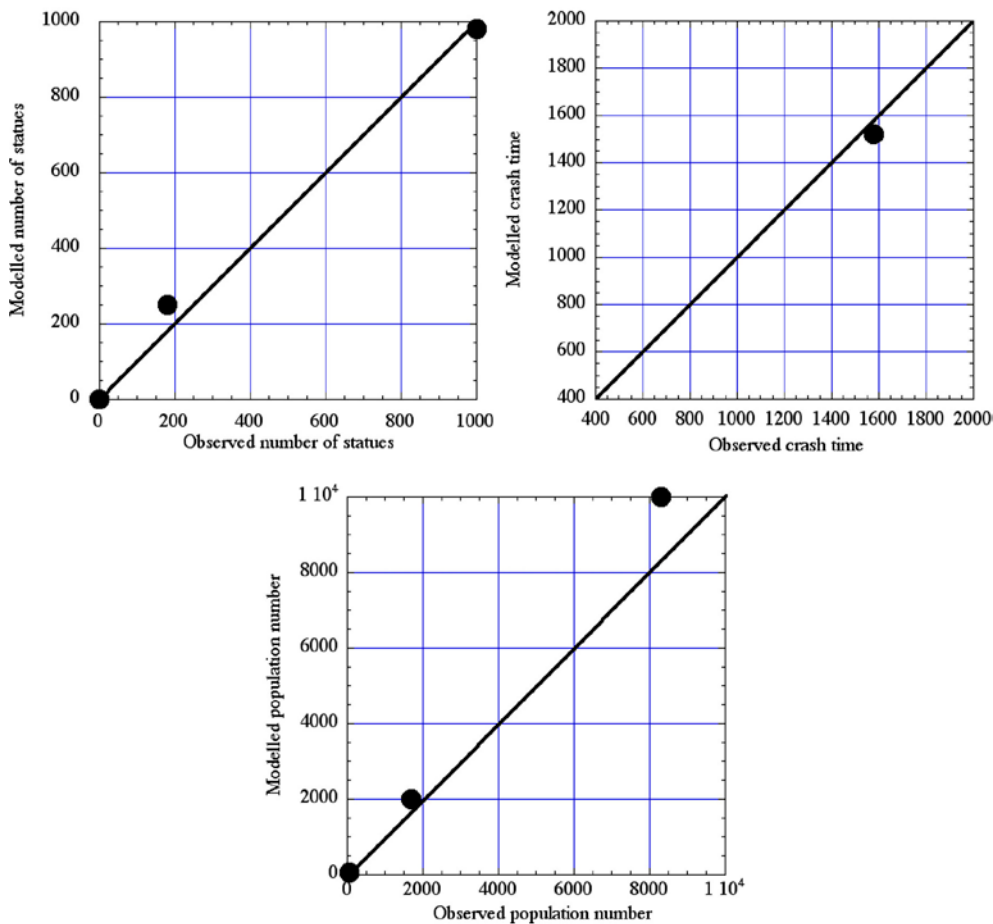

Figure 4.47. Validation of the model we constructed for Easter Island. We can see that our predictions appear to be reasonable with respect to the known history.

Sensitivity analysis. We may do a sensitivity analysis of the model. The STELLA system contains a feature that makes this really simple, and we will test this on the Easter Island case. We have chosen three parameters for our sensitivity analysis of the model: forest regeneration rate; efficiency of fishing; and effect of religion efficiency. The forest regeneration rate ranks from 0.01% per year to 0.02% per year. The efficiency of fishing from the boats goes from 30% (one boat feeds 60 people) to 310% (one boat feeds as many as 620 people). The efficiency of the religious practice measures how fast the population falls into disbelief after a major statue-building events between 500 AD and 1500 AD, which is three times faster erosion of the society into collective disbelief.

The results are displayed from top to bottom: boat fishing efficiency, religious efficiency, and natural forest regeneration rate. Variability in fishing efficiency has some effect on the stress levels and the date of onset of the disaster, but decreased levels do not prevent the society's collapse.

Table 4.2. Steps for varying the parameters in the sensitivity analysis of the Easter Island model.

Parameter used	Steps taken				
	1	2	3	4	5
Religious efficiency for relieving stress	500	750	1,000	1,250	1,500
Efficiency of fishing from boats	30%	100%	170%	240%	310%
Natural regeneration rate for the forest	0.01	0.0125	0.015	0.0175	0.020

In addition, changes in religious efficiency do not change the onset time of the disaster more than marginally. However, changing the rate of natural forest regeneration rate has a profound effect on the fate of the Easter Island. A high rate prevents the disaster but stabilises the population at a high level albeit a somewhat stressed level. This analysis and further sensitivity analysis show that only two parameters have a significant effect on the scenario trajectories for Easter Island, and only these two parameters will be significant for making Easter Island sustainable: family planning and birth rate control and forest management through replanting and enhanced natural regeneration of the forest.

No other parameters have a large enough effect on the trajectory to make the island sustainable. The forest management is about managing the most valuable natural resource on the island. Family planning is about not outrunning the available resources as well as society's ability to adapt a philosophy, social standards, and norms to allow for birth rate management. Figure 4.48 shows the sensitivity analysis outputs for religious effect by varying (a) religious efficiency rate and (b) religious efficiency rate and fishing efficiency rate and (c) religious efficiency rate, boat fish catching efficiency, and natural forest regeneration rate. Figure 4.49a,b shows the sensitivity analysis outputs for social stresses by varying (a) religious efficiency rate, (b) religious efficiency rate and boat fish catching efficiency, and (c) religious efficiency rate, boat fish catching rate, and natural forest regeneration rate. Figure 4.50 shows the sensitivity analysis as seen in number of trees in the forest by (a) varying religious efficiency rate, (b) religious efficiency and boat fish catching efficiency, and (c) religious efficiency rate, boat fish catching efficiency, and natural forest regeneration rate.

THE TAKE HOME LESSON

The example of Easter Island is a complex system that can be modelled, including its social system. Easter Island's social system plays an important controlling role for the fate of the physical system as is evident in the field data, which is used to check the accuracy of the model. That is, the model accurately describes and predicts the recorded history of the island using rather simple principles and parameters. The main parameters are relevant in the physical world and can in some instances be measured in the field.

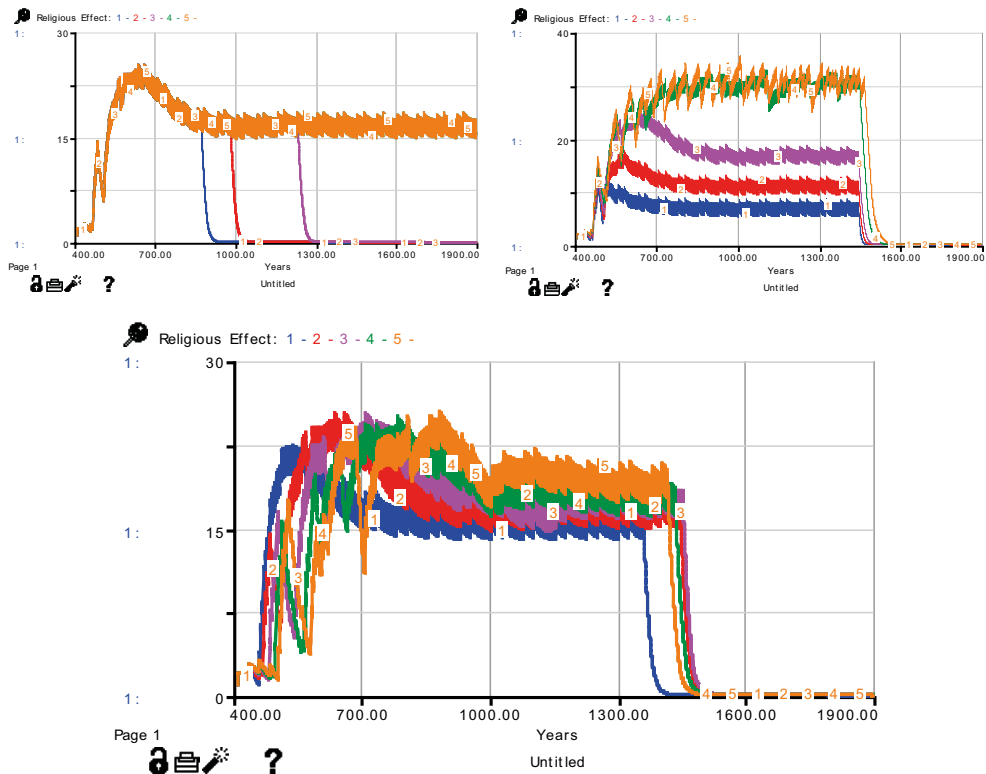

Figure 4.49a. Sensitivity analysis outputs for religious effect by varying (a) religious efficiency rate and (b) religious efficiency rate and fishing efficiency rate, and (c) religious efficiency rate, boat fish catching efficiency, and natural forest regeneration rate.

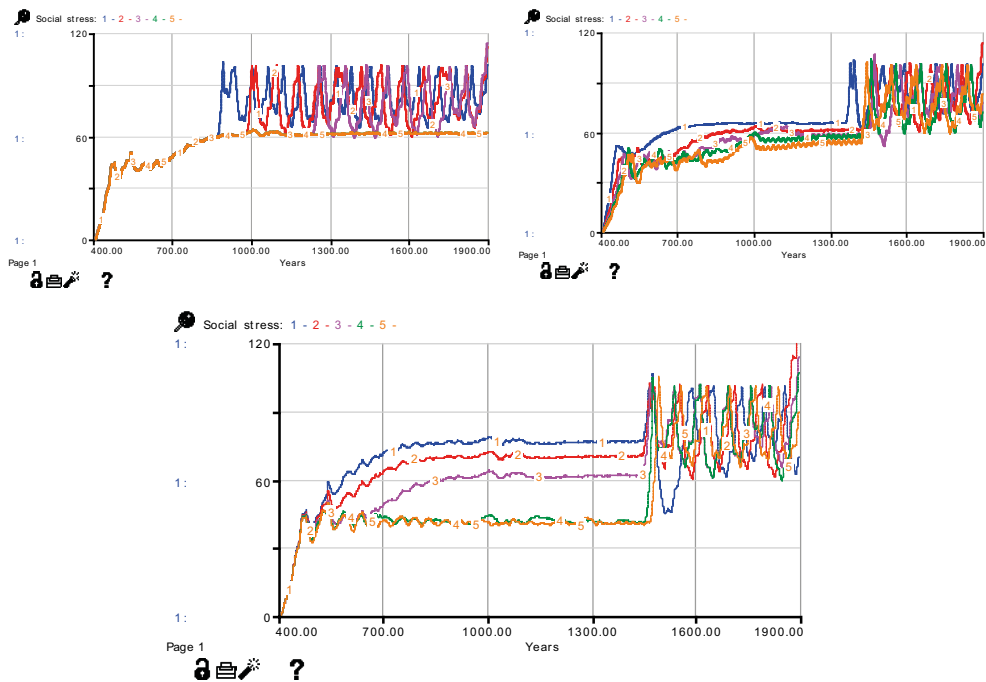

Figure 4.49b. Sensitivity analysis outputs for social stresses by varying (a) religious efficiency rate, (b) religious efficiency rate and boat fish catching efficiency, and (c) religious efficiency rate, boat fish catching efficiency, and natural forest regeneration rate.

Obviously, the fate of the island's inhabitants was tied to limited resources irrespective of religious belief. That is, offering sacrifices and prayers were ineffective means of ensuring sustainability. Sustainability is a concept that requires the proper use of reason and science rather than instinctual and opportunistic behaviours.

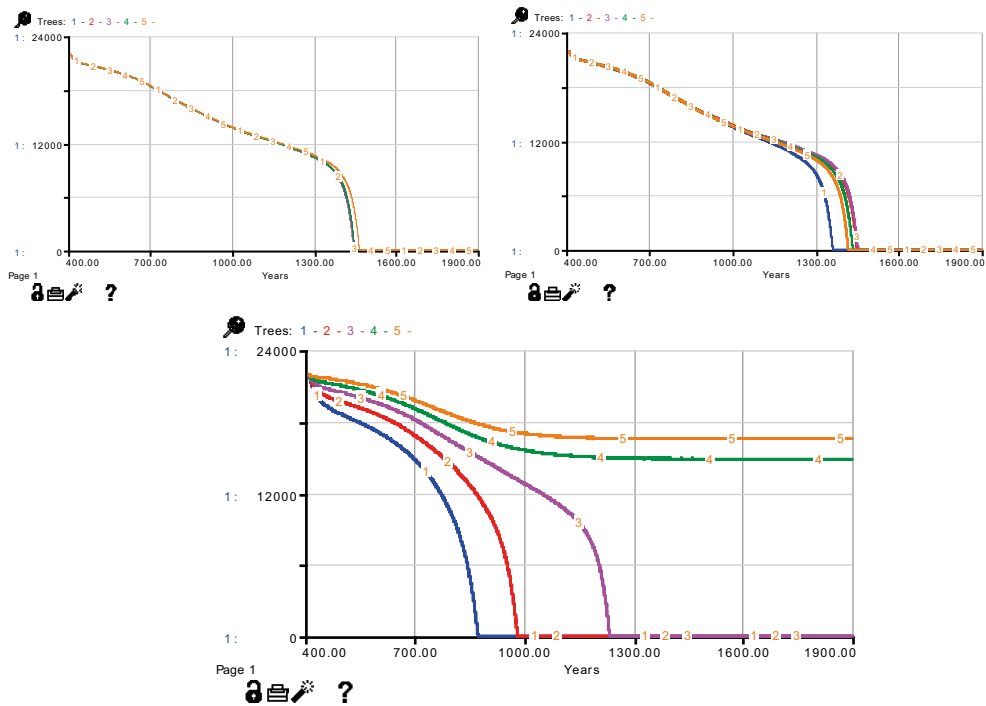

Figure 4.50. Sensitivity analysis as seen in number of trees in the forest by (a) varying religious efficiency rate, (b) religious efficiency and boat fish catching efficiency, and (c) religious efficiency rate, boat fish catching efficiency, and natural forest regeneration rate.

Who can save the Earth? Well, only the humans can save humanity from human impact, and this requires foresight and long-term consideration of consequences of people's interaction with their environment, including fellow human beings. In the 7,000 years of recorded history, there are no documented cases where prayer and other appeals to religious concepts have rescued humanity from its lack of planning for sustainability. Clearly, a god, irrespective of religion, does not intervene in human affairs of this sort. All future planning must be based on intelligent consideration, empathy, accountability, and a thorough understanding of the full implications of natural and social sustainability.

5 Understanding some case studies

5.1 Interpretations

5.1.1 Example 1: Measuring performance. Eco-living vs. Conventional living

After the release of the Brundtland commission's (1987) report entitled *Our common future*, there has been a wealth of research that has been devoted to defining sustainable development and how it should be measured. Several indicators have been developed for measuring performance for sustainability. Their use and application is well documented by Roberts et al. (2002) and individual performance is thoroughly summed up by Finnveden and Moberg (2004). In this case study, a combination of indicators are used to make comparisons that are not possible when using the indicators individually.

According to Rees (1997), cities consume resources that need up to ten times more land area than found within their own city boundaries. Cities cannot be defined as sustainable since they use resources that originate beyond their geographical boundaries. In Sweden, there has been focus on establishing eco-villages as a way to demonstrate less resource intensive ways of living (Gunther, 1989). For example, several experiments have investigated how construction and planning of housing are intertwined with the concept of eco-living – i.e., adopting a less resource intensive lifestyle (Malbert, 1994). Measuring performance of eco-villages has often focused on housing construction such as using better building materials for insulation or using recyclable materials. However, little focus has been directed at how well the eco-villages perform in general as part of their society. From a holistic perspective, there is a need to identify what the key parameters are for reducing resource use in residential living and to determine whether eco-villages are doing as much as they can in this regard.

Haraldsson (2000) compares the performance of conventional living in Sweden and the eco-village Toarp. The study asks whether eco-living is actually more efficient than conventional living in terms of energy use for construction in Sweden. Although specific, the question stated for the problem occupies two levels in the system level hierarchy. For example, the construction phase was short but crossed several system levels and the use phase was high but crossed a long temporal scale (Figure 5.1).

The housing construction phase lasted between two and three years, but since the raw materials required for the construction originated from all over the globe, the construction crosses many system levels. The use phase of housing (i.e., the living) lasts for at least 50 years. Therefore, the use phase, which includes lifestyle, is placed high on the system level but crosses a long time frame. To merge these two levels, the analysis designates energy use as the common denominator. Thus, the system boundaries were drawn around the resource extraction and fabrication of the material as well as the transportation of resources and materials to the building site. The system boundaries for the use phase were set around individual housing with a time scale

of 50 years. There was a need to combine two methods to deal with both the details on the lower level and address the higher level. In the energy analysis for the construction phase, Life cycle inventory (LCI) (Lundblad and Paulsen, 1996) analysis was performed to determine energy used. For the use phase, the Ecological footprint analysis (EFA) (Wackernagel and Rees, 1996) was applied. This combination of LCI and EFA allowed for a comparison not possible when the methods are used separately. Figure 5.2 shows results from the analysis, which includes the previously discussed housing category among other categories tested.

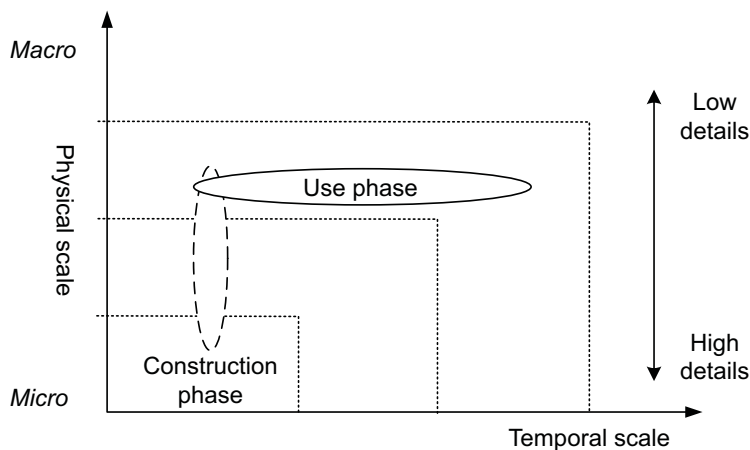

Figure 5.1. The comparison in the study focused on two aspects: the construction phase and the use phase. The construction lasts between two and three years, but the use of the housing is much longer.

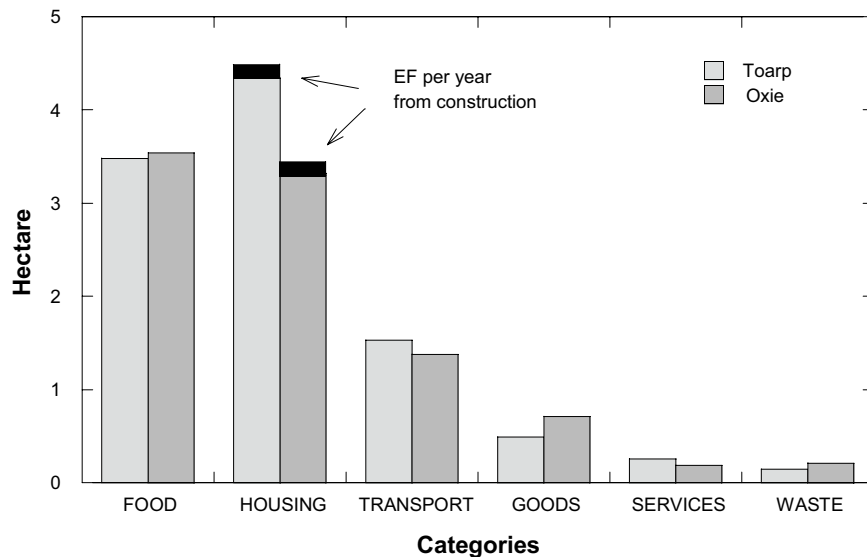

Figure 5.2. The construction phase of housing is insignificant in comparison to the total use of the house when according to the Ecological Footprint (EF) (Haraldsson et al., 2001).

What was previously considered important (i.e., the type of building materials) became insignificant in comparison to the lifestyle of the people using the housing. In fact, the focus shifted from the construction and insulation properties to lifestyle. That is, this analysis (the testing of the assumptions) revealed that building materials were far less important than lifestyle: eco-living failed the test. The new suggestion became that lifestyle needed to be considered. This suggestion shifted the focus to new questions about permaculture (permanent agriculture) and eco-villages in general. The study also shows the importance of sorting indicators according to hierarchical levels. Indicators uncovered through LCI and EFA address different levels and treat time differently.

5.1.2 Example 2: The Icelandic vegetation dynamics and carrying capacity

These studies came from an interesting research problem that has been under debate for several decades. In the early 1960s, Þórarinnsson (1961) used tephrochronology studies – i.e., the study of volcanic ash layers to create a chronology of paleoenvironmental or archaeological records – to illustrate that gradual land degradation had taken place during and after the colonisation of Iceland 1,100 years ago. He hypothesised that extensive use of natural resources, such as the cutting down of trees and the grazing of domestic animals, fuelled erosion processes that caused a gradual but systematic loss of vegetation cover. Further studies by Einarsson (1963) indicate that vegetation cover before the settlement period was twice the current amount – i.e., 50% of the total land area. Using pollen data, Einarsson also showed that forests covered at least 1/3 of the total land area. This fuelled a fierce debate that focused on two details: the extensive use of trees by the early settlers and the overuse of the rangelands to sustain domestic grazing animals. These actions were believed to be the main cause of erosion and subsequent land degradation. Erosion was further thought to have caused a severe reduction in the carrying capacity of the rangelands for later populations (Þorsteinsson, 1972). In recent years, the focus has been on the contribution of climate change (Dýrmundsson and Jónmundsson, 1987), but not much work has actually focused on assessing how much of the degradation was due to the settlers and how much was due to climatic change. Climate records are now available from the Greenland ice sheet that show how a paleoclimate in Iceland might have developed during the Holocene (Dahl-Jensen et al., 1998).

The purpose of the Icelandic case studies on vegetation dynamics was three-fold:

1. To estimate the total vegetation cover in Iceland during the whole Holocene;
2. To analyse the long-term land degradation in Iceland by comparing simulated maps of vegetation cover at different periods to current vegetation cover; and
3. To estimate the carrying capacity of the Icelandic land environment for sustaining a human population during and after the settlement period.

During all the case studies, the approach was simplicity and transparency. In the definition phase, the purpose and the questions of the study were established. Furthermore, the focus of the problem and the questions could be placed in a system level hierarchy. In the clarification phase, the understanding of the basic processes at work in land degradation and the contributing factors were established as seen in the CLD (Figure 5.3). Data requirement was established from the sorted variables and an equation CLD was constructed as well as an SDTD. In the confirmation phase, the data were prepared and the coefficients for the model and numerical system boundaries were set. During the implementation phase, scenarios were tested and results interpreted for the stage I model (the Vegetation and forest cover model, VFC) and the stage II model (the carrying capacity for human population in Iceland, Ice-CC). The projects went through many iterations of the learning loop during the whole process. Although the CLD in Figure 5.3 was not a direct translation of the SDTD used to produce results, its purpose was to give the reader an overview of the degradation processes in Iceland and show what parts of the system the model was addressing. This encircled the domain of the problem. This insight was important when pursuing the work as it helped maintain transparency during the process. The preparation of the input parameters actually required this overview and later, when the erosion models were prepared, the overview served as an aid for deciding the level of details for the new modification of the vegetation model (i.e., how much stratification was necessary for the vegetation cover at different elevations). The erosion model was a specific question within the problem dimension and therefore placed lower in the system level hierarchy but within the same temporal scale as the vegetation and human population model (Figure 5.3).

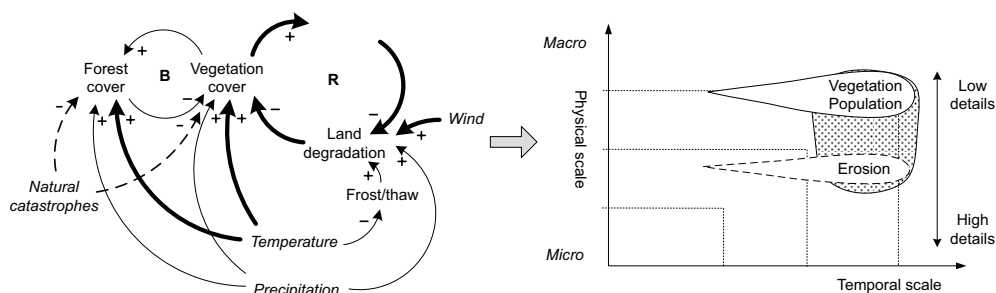

Figure 5.3. The basic CLD of the problem dimension and its place in the system level hierarchy. The erosion model addressed a specific question and therefore added to the original model. The strong influence factors are shown with thick arrows.

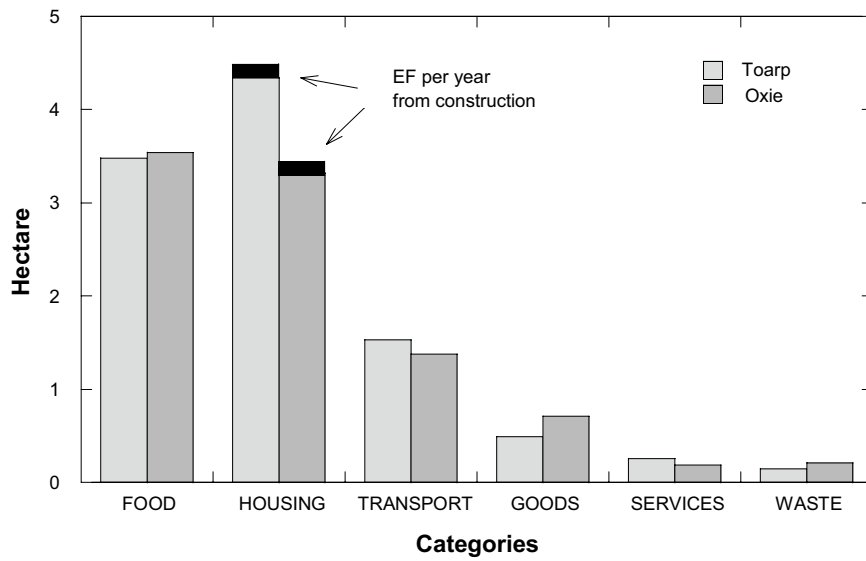

Figure 5.4. A simple overview of the erosion model for Iceland in a CLD and an SDTD.

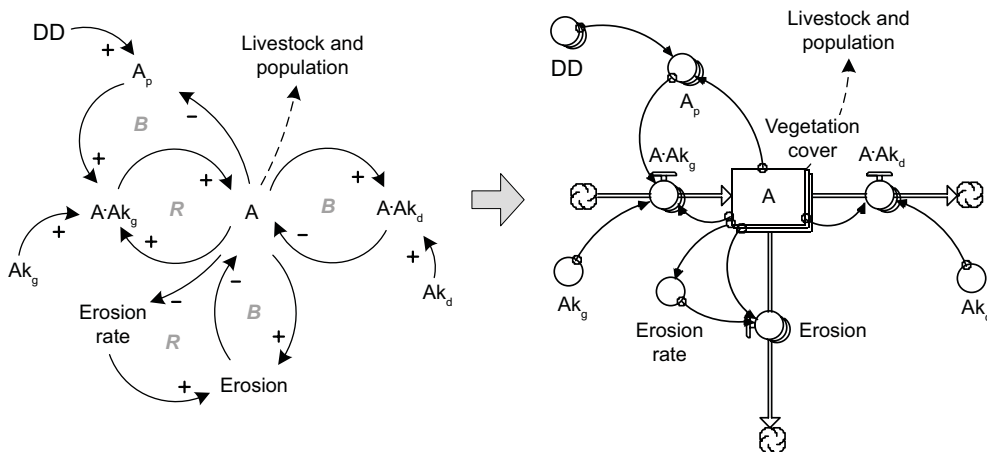

Figure 5.5. A simplified overview of the Ice-CC, from CLD to SDTD. The conversion of the CLD to SDTD is straight forward and the graphical similarity is easily seen.

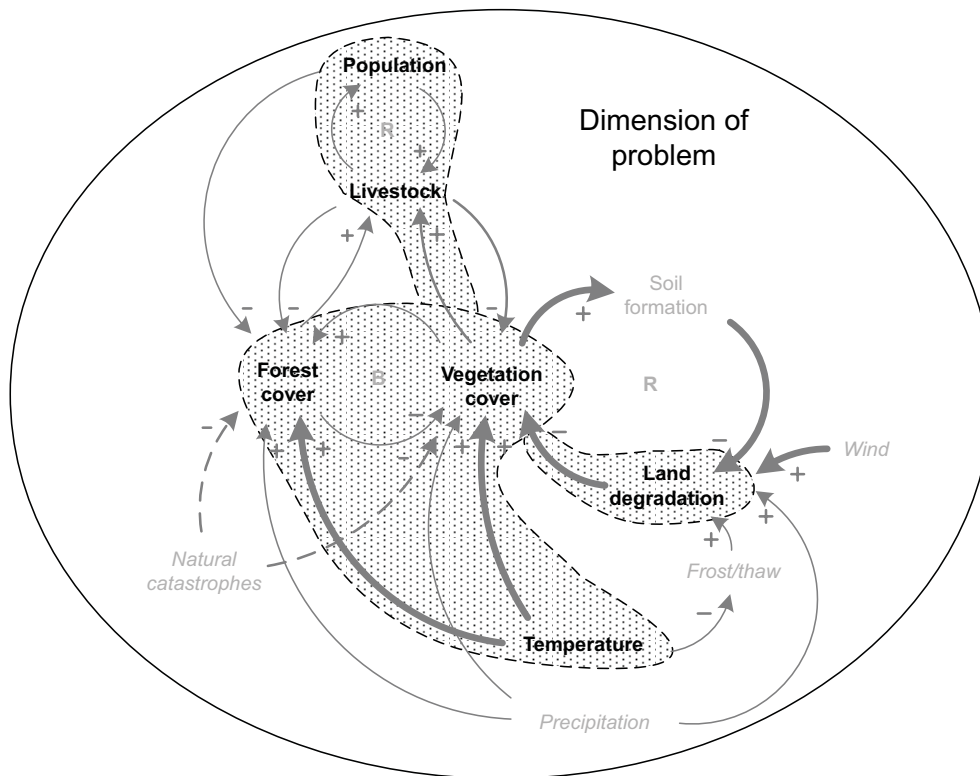

Figure 5.6. The combined models addressed specific questions within the problem dimension – i.e., vegetation cover (and forest) in the VCF, land degradation with the erosion model, and carrying capacity with the Ice-CC model.

To maintain transparency, CLD and SDTD were constructed to show more specifically how erosion affected the vegetation cover at different elevations (Figure 5.4 and Figure 5.5). The Ice-CC model was constructed as a combination of the simplified version of the VFC, the erosion model, the livestock model, and the population model. The Ice-CC model is shown in Figure 5.5. The human population model relied on the output of the modified vegetation cover erosion model to simulate the number of people who could be supported by the livestock. Although very simple, this approach provided answers on a conceptual level about how many people the Icelandic environment could sustain. By comparing the observed historical situation to the simulated output of the model, the study answered the main question: What does climate contribute to degradation in Iceland? Furthermore, the same model with little modification on an overall level showed revealed the maximum population possible.

Being able to answer these questions was possibly due to the transparency in the process and the understanding of the whole model utilisation process. Figure 5.6 is the basic CLD showing the overview of the processes and the dimensions for the issue. All specific questions asked in the studies were focused on specific items within the dimensions. These studies have raised several questions about erosion and land degradation – i.e., the pace of erosion in different stages and its impact on a spatial scale. These questions will be addressed in the continuation of this research.

5.1.3 Example 3: The generic archetype – Tyranny of small steps

The Tyranny of small steps (TYST) generic system archetype was discovered and developed in a continuation from a case study of the Örby water treatment facility of the Örby field aquifer, a shallow natural aquifer several meters thick covering an area of 520 hectares (Haraldsson et al. 2008). The Örby field is a natural infiltration bed where surface water is filtered through the gravel to provide a clean drinking water. Near Helsingborg in southern Sweden, the Örby facility was constructed 60 years ago to harness the drinking water from the Örby aquifer for the Helsingborg municipality and the facility continues to operate today. However, in recent years, problems have threatened the function of the Örby field and facility. New water sources from nearby municipalities have rendered the extra purification stage of Örby field obsolete and urban encroachment is slowly reducing the area of the field (Gramstad, 2004). Three group model building sessions were carried out with the municipal water department and the housing office to define and clarify the problem, resulting in several specific questions regarding the Örby field facility, including its purpose and its role for the municipality. The qualitative analysis confirmed some key issues: the Örby field has a special regional role regarding water security and that security is being threatened by slow urban encroachment.

The TYST archetype was developed to explain the properties of the encroachment and how it manifested in the first place (Haraldsson et al., 2008). The TYST, serving as the implementation phase, aided the municipal departments implement strategies to avert the problem. It was soon discovered that there are two processes at work simultaneously in Helsingborg that affect decision making: urban planning by the city planning office and virtual planning by the local housing office. The official urban planning document is a master plan or comprehensive plan for urban design for the next 20 years, updated every five years. The city planning office forms the comprehensive plan for the politicians of the municipality to approve or disapprove. Once the municipality agrees on a comprehensive plan, the plan guides the civil servants of the housing office in its responsibility for granting applications for development. After an individual applies for a construction permit, these civil servant consult the comprehensive plan before granting any application. However, since the comprehensive plan is a non-binding document, there are no real consequence if some of the principles in the comprehensive plan are ignored. If the civil servant denies an application, the applicant has the possibility to appeal the decision. Similarly, if the granted application requires public debate, the public also has a possibility to appeal the decision. However, if a granted application goes through the process unnoticed, there will be no one to make any objections of the application since there is no one guarding the interest of the comprehensive plan, as that is the public's responsibility.

Applications are usually advertised in the media, but the media outlets used reach only a small number of the population, who are not necessarily relevant stakeholders. Therefore, the civil servants possess a great a deal of power in the planning process although they are not directly part of the overall urban planning process. However, this procedure is not the same for all

municipalities and may in fact not be as common as portrayed here. Nonetheless, municipalities need to address the question if such processes are in fact present in their current routines.

In the Örby case, there are two systems working on different scales. The planning office supervises the comprehensive plan and views the Örby field as a static object with fixed boundaries. The local housing office views the comprehensive plan document as a non-binding guiding document, so deviation from the plan due to political pressures is possible. Because there is a difference in resolution between the scales, small activities are not detected. That is, the detection level of the city planning office is not sharp enough to register the changes and stop the encroachment.

The two processes are working on different time scales: the decisions by the civil servants are made on a day-to-day basis and decisions made consulting the comprehensive plan are on a five-year basis. As a consequence, when the city planning office reviews the comprehensive plan every five years, it adjusts the comprehensive plan to incorporate the changes of the past five years, so encroachment is allowed to continue, slowly but steadily.

The principles of TYST can be explained as an unwanted change to a system through a series of small independent activities. These activities are small enough not to be detected by the surveillance within the system, but significant enough to encroach on the tolerance zone of the system and compromise the integrity of the system. TYST is an unintentional process that is experienced within a system and made possible by the lack of transparency between an overarching level and the local level where the encroachment is taking place. Figure 5.7 illustrates an example of the TYST archetype in the Örby case. The overarching level is slower than the local level (indicated with a double strikethrough on link delays), so the information reaching the revision of the comprehensive plan is delayed beyond the ability of the master plan to halt or revert the encroachment (Haraldsson et al., 2008).

ON GENERIC ARCHETYPES AND TYST

Haraldsson et al. (2008) make a strong case that the observations made at the Örby field are in fact a generic system archetype behaviour and can be classified as an archetype according to the definition of archetypes (Senge, 1990; 1994). There exists some discrepancies in the literature on the usefulness of archetypes (Paich, 1985) and how they should be applied (Wolstenholme and Coyle, 1983). Archetypes require careful consideration before they are implemented. Vennix (1996) considers the use of archetypes risks creating premature recognition that might result in ineffective policies. On the other hand, Senge (1990) views archetypes as powerful tools that provide behavioural insight into problems.

Lane (1998; 2000) describes many fundamental issues with using generic structures (archetypes) in SD. For Lane, archetypes are too loosely defined and have been interpreted without the necessary validation. These conditions call into question their current theoretical status in science. Therefore, archetypes have been used in the background – i.e., they are not explicitly mentioned

but explained as a behaviour that is steered by specific goals within the system (Sterman, 2000).

However, the development in recent years has shifted the focus somewhat back to Senge's original thought on archetypes. Wolstenholme (2004) describes the use of archetypes as a means to improve conceptualisation and communication. Moreover, Wolstenholme believes archetypical behaviours can be transferred from one domain to another. Wolstenholme, however, shows his hesitation by arguing that the concept of clear system boundaries is still missing in the current representation of archetypes, a limitation that makes their interpretation difficult. Senge (1990; 1994) originally described 11 system archetypes. In his recent work, Wolstenholme (2003) argues for reducing the number of archetypes in order to make them more generically applicable. He suggests four generic structures in which all current archetypes should be placed: underachievement, out of control, relative achievement, and relative control. These archetypes can generally be identified with two loop structures that are represented as problem archetypes and solution archetypes. Solution archetypes involve a solution link to break the problem behaviour of the archetype. It is possible that the four generic structures identified by Wolstenholme (2003) may in fact be representative of two-scale archetypical behaviours that are applicable for certain types of problems. The underachievement and the out of control archetypes work on a local system level, whereas the relative achievement and relative control work on a higher system level or on an overarching scale.

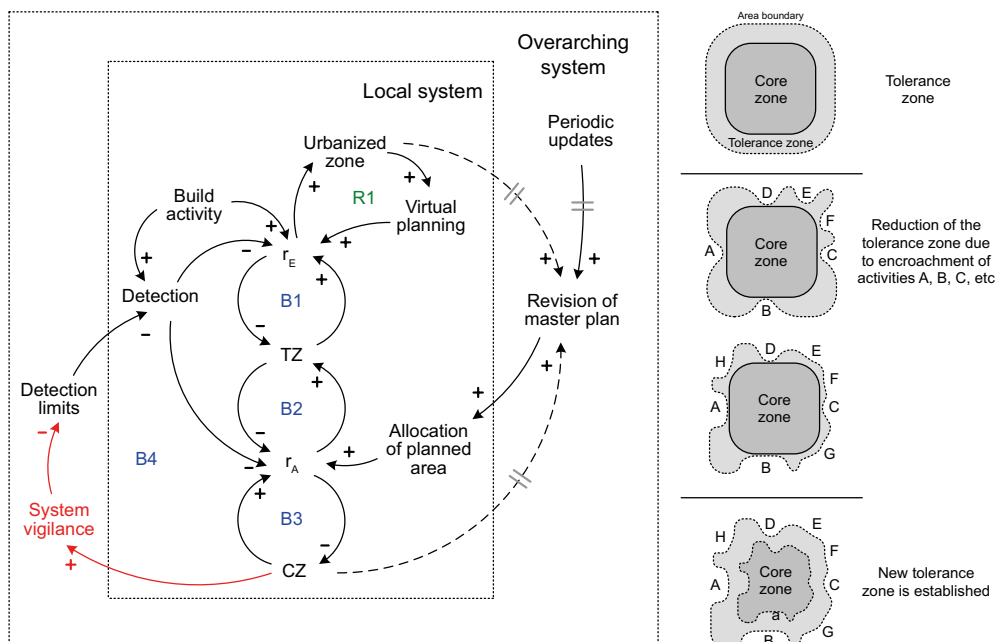

Figure 5.7. The overarching system works over a longer time scale than the local system, so the changes made within the local system are not detected. Creating watch dog helps detect the necessary transparency for the overarching level and prevent the encroachment. The local level includes the Core zone (CZ), the rate of allocation to Core zone (r_A), the Tolerance zone (TZ), the rates of allocation to encroachment (r_E), and detection. The Encroached zone (EZ) resides on the overarching level.

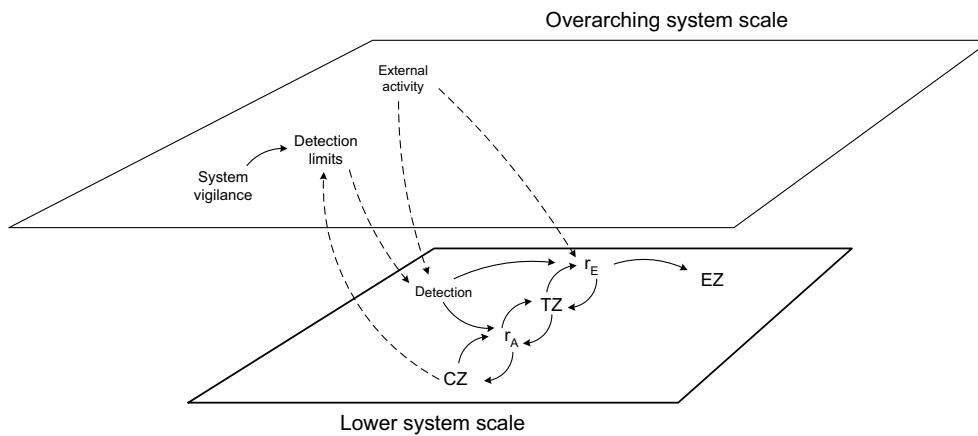

Figure 5.8. The TYST archetype works on two hierarchical system levels: a local scale that is fast paced and an overarching level that is slow paced.

This is supported by the fact that the underachievement and the out of control archetype structures are a result of local mechanisms within the problem and the solution lies in halting or modifying one of the endogenic variables causing the changes. The relative achievement and relative control archetypes stem from exogenic activity, where an effort is put into achieving or controlling variables at the expense of other systems.

ON SYSTEM LEVELS AND TYST

It is perhaps possible to identify TYST as a relative control structure since it has the properties of an overarching scale archetype. It incorporates the function of controlling an activity that is generated internally but not detected by the overarching system. The effected system is influenced by independent exogenic activity that causes the archetypical behaviour to manifest (Figure 5.8). A common problem with archetypes is that they often describe the problem as well as provide a solution to problem using the same variables (Wolstenholme, 2004). This error stems from ignoring system scales. For TYST, the solution exists only on the overarching level, as it cannot exist on the lower level since the communicative variables for detection reside on the higher level. Therefore, the remedy for countering the behaviour of the archetype resides in the overarching level, which introduces the vigilance variable. The vigilance variable is the surveillance within the system that keeps an eye on the activities on a lower level. The discovery of the TYST archetype was only possible due to the clear definition of the system boundaries, which enabled the necessary transparency to place the behaviour on two level scales – the overarching and the lower system scale. Furthermore, the TYST archetype has strengthened the assertion that system boundaries and how they are defined in relation to the problem domain are central for generating the necessary overview to deal with the problem and find useful solutions.

5.1.4 Example 4: The Hallormstaður project – The Innovation process

Hallormstaður is a forest research facility that promotes reforestation of Iceland. In the past, Iceland has supported a forest ecosystem but most of this has disappeared through extensive use by the early population and general environmental degradation (Þórarinnsson, 1961). It is estimated that forests in Iceland covered most of the lowland regions in the pre-settlement period. Afforestation in Iceland is a recent occurrence and has for the most part been associated with re-vegetation as a preventive measure against soil erosion. Only a few areas in Iceland have been purposely set aside for forestry, and large-scale forest plantation is in its infancy.

Reforestation has suffered from the lack of historical forestry practices in Iceland, so there is little historical knowledge, for example, related to best places for forestation. To remedy this lack of knowledge, several experiments have been conducted to observe how different tree species cope with Iceland's environmental conditions (Sigurðardóttir, 2000).

The oldest and largest planted areas are in Hallormstaður in eastern Iceland and consist of larch (*Larix sibirica*) and birch (*Betula pubescens*). Icelandic soils are of volcanic origin and have unique properties regarding sequestering of carbon and nitrogen (Óskarsson et al., 2004). The development of soil nitrogen and carbon at the Hallormstaður site reveals some puzzling features. These features were investigated using the FORSAFE model (Wallman et al., 2004). Specifically, the FORSAFE model was used to conduct basic tests on the site to address four issues:

1. to predict forest production of the native plant species and the imported ones;
2. to explain and predict the fate of carbon and nitrogen in the forest system;
3. to assess possible changes in ground vegetation; and
4. to document and assess the need to adjust FORSAFE in order to address issues 1–3.

Since FORSAFE is a recently developed modelling tool, it needed adjustments for the conditions in Iceland. The Icelandic conditions can be considered extreme as the soil conditions do not follow the development of classical stratification of podsoles (infertile acidic soils). Icelandic andosols (soil formed from volcanic material) are very homogenous due to their unique soil formation processes. Apart from plant decay, two other processes are involved in soil genesis: tephra and post-glacial silt material deposition via wind and eroded rofabard (Arnalds et al., 1997) deposition via wind.

The chemical properties of Icelandic andosols required changes in the fundamental modules of FORSAFE that dealt with chemical weathering of minerals. Adjustments in the model concerning tree growth and the accumulation of carbon had to be made. Therefore, several group sessions with the stakeholders in Iceland were conducted to determine how the model could be improved with the incorporation of the changes necessary to produce outputs and simulations that could be interpreted.

THE METHOD FOR GROUP MODEL BUILDING FOR HALLORMSTAÐUR.

The FORSAFE model was developed through the SUFOR and the ASTA programmes over five years. The project in Hallormstaður used the group model building process where different people coming from different disciplines were involved in forming the goals and implementing the working goals of the project. The challenges in the AFFORNORD called for a focus on some of the basic principles within the Model utilisation process. Since the current version of FORSAFE was not adapted to the environmental conditions in Iceland, there was a need for a group that had the sufficient academic knowledge to deal with the questions FORSAFE addressed. Therefore, a team was formed from people with the relevant knowledge in forestry and plant ecosystem processes. The goal of the meeting was to address the needs of FORSAFE by forming main goals for the simulations and several working objectives to follow up. Two group model building sessions were conducted over two days. These sessions were prepared as follows:

System analysis was used to define goals, working objectives, tasks, and tools needed for the process.

The necessary knowledge developed for the first part was enabled after several iterations through the learning loop.

Traditional computer programming for generating a numerical understanding of the knowledge was performed.

A case study was prepared to anchor the effort to real world settings.

Group model building sessions were conducted to interpret the simulated outputs into understandable results and policies.

The ultimate goal for the process was a model that could predict ground vegetation dynamics in terrestrial ecosystems by considering climatic variables, pollution, land management, and changes such as erosion on a geographical scale. Among the methods used for the process was the Delphi method (Adler and Ziglio, 1996). The facilitators used a modified process of the Delphi method in the group model building, where the members were identified and stakeholders were directly involved. The group modelling process adopted the approximation method ‘best available expert estimate’ when developing the understanding of the feedback processes and performing the numerical estimates for individual response factors for the preparation of FORSAFE input data. The main approach was to use individual response factors that were communicated through feedback loops using model structures to reconstruct the integrated ecosystem responses (Figure 5.9). The group model building process adopted the learning loop and iteratively went through the

four innovation phases: defining the problem and asking the questions; clarifying the working objectives and testing new understanding qualitatively and quantitatively; confirming the right question and verifying the model structure; and implementing the changes into FORSAFE and documenting the results.

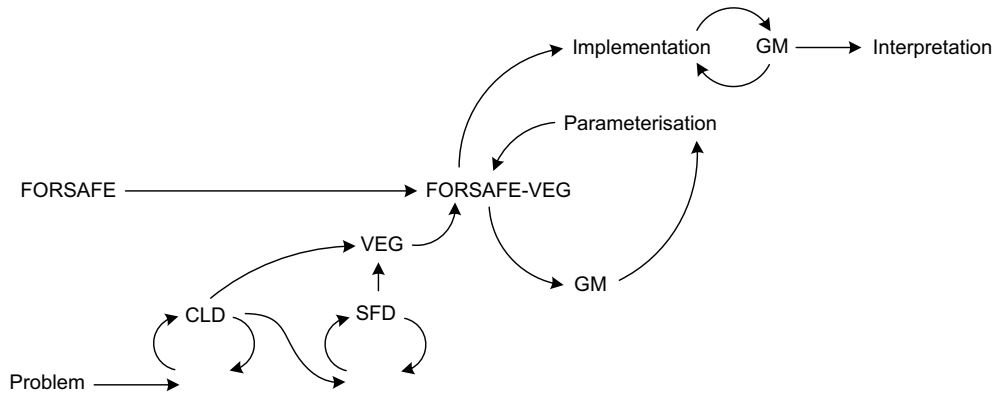

Figure 5.9. The workflow as it has been organised for the Hallormstaður site. GM = group modelling; CLD = causal loop diagram; SFD = stock and flow diagram. FORSAFE, VEG, and FORSAFE-VEG are acronyms for numerical codes programmed in Fortran. At present, the study has reached the parameterisation stage.

Some of the questions developed during the process were easy to answer since they overlapped with questions developed in the early phase of the initial FORSAFE development. Other questions needed preparation and testing during the meetings and as homework so members could test the new understanding against their field data. The homework phase acted as an intermediate stage performed between the meetings. The ideas were generated and tested in the group modelling sessions and further tested or verified in the homework process. This was the case with the AFFORNORD project meeting in Iceland. The following parameters and modules were considered:

1. Basic parameterisation of the FORSAFE model (Aber and Federer, 1992) for the tree species to be simulated (i.e., birch and larch); and
2. Development of a sub-model for grass production for open land, representing the pre-step for introduction of tree species to the area.

For the first issue listed above, FORSAFE did not need to be adapted further from its current state. For the second issue, there were extensive changes needed that involved conceptualisation, definitions, parameterisation, testing, and programming.

5.1.5 The modelling procedure and the group Innovation process.

A successful modelling procedure requires understanding the following key concepts:

1. the problem dimensions where the issues reside;
2. the temporal and physical scales;
3. where in the scales the problem manifests (this enables the identification of feedbacks, their delays, and their type).
4. what questions are important to reveal the problem structure and explain the symptoms.

The questions stated are only possible to answer if the above concepts are understood.

Among other things, the group model building enhances this understanding. As discussed by Vennix (1996), group model building, if properly done, will always foster better understanding of the system and its feedback loops than attempts made in isolation, a conclusion also apparent in the examples discussed here. Furthermore, group model building goes through four innovation process steps – definition, clarification, confirmation, and implementation (Figure 5.9) – where each step is a turning point for the group's understanding of the issue. The modelling procedure is connected with the innovation phase as illustrated in Figure 5.10.

The modelling procedure in Figure 5.10 connects the innovation phase through the qualitative phase – i.e., the development of the theoretical principles and the numerical model, going from CLD and/or SFD to SDTD. The constant iteration of the learning loop moves the process from the conceptual phase to the numerical phase. As with the development of the conceptual model, the creation of the SDTD is done at earliest in the second iteration of the problem (Figure 5.10). The development of the SDTD also goes through the definition, clarification, confirmation, and implementation steps. When the mental model has been tested and revised in the confirmation phase, it moves to the next iteration cycle where SDTD components are defined, clarified, and confirmed.

This process is integrated so the CLD and the SDTD are adjusted in the following phases to check if further reiterations are required to answer the question posed for the problem. The conclusion is only implemented if the conceptual model and the numerical model correspond, which may require several iterations through the learning loop (Figure 5.11).

Depending on the type of problems at hand, the CLD can be developed first, but some problems (i.e., specific processes) are better described with a SFD, which should be developed first. It is often best to develop the CLD with the support of the SFD to identify the properties of the variables (i.e., agents, actions, and controls). Once one has been trained in the CLD concept sufficiently, there is little need to create an SFD since the modeller is already skilled in seeing the rates and fluxes within the CLD and can translate these into a SDTD easily. For pedagogical purposes, the CLD should be the final

mental model that is presented as a result, with a supporting SFD to explain it (when needed). The modelling procedure, the innovation phases, and their iteration through the learning loop can be summarised as management planning (Sverdrup et al., 2002). Sverdrup et al. (2002) summarises the planning and design process (Figure 5.12), which also becomes an iterative process where a designed plan is modelled so that predicted output can be compared to intended goals. Plans that are predicted to yield results that come close to the intended goals are kept; all others are either scrapped or modified.

Senge (1990; 1994) has similarly termed this process as the adaptive management process. Senge (1990; 1994) and Vennix (1999) discuss the importance of team learning that is adaptive. Adaptive management should focus on understanding the structure of project planning and on shared language through generic structures in order to predict behaviour and outcome using group model building. The learning loop in adaptive management becomes an adaptive learning process.

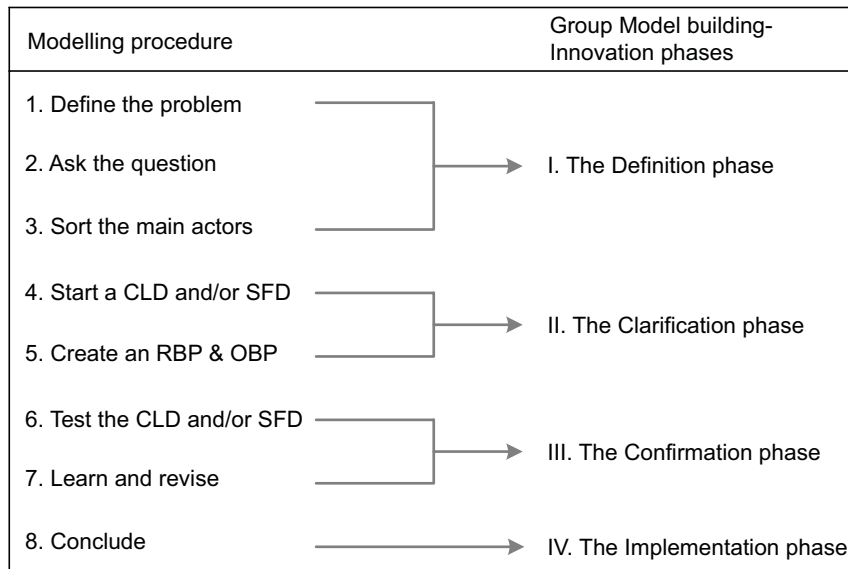

Figure 5.10. Each step in the modelling procedure manifests in the innovation phases.

In the case studies discussed here, we have encouraged designing a research plan with attainable goals given the scope of the problem to be addressed and the questions to be answered. For the Icelandic case, the complexity of the problem and the dimensions that involved land degradation processes, re-vegetation, grazing management, etc. indicated that the studies would have to include multiple questions that were unanswerable given the time frame intended. Therefore, the management plan was adjusted for goals attainable during the given time frame. One of the main goals was to obtain an overview of the basic processes. This framed the problem dimension for land degradation in Iceland and was suitable as a starting point for the research.

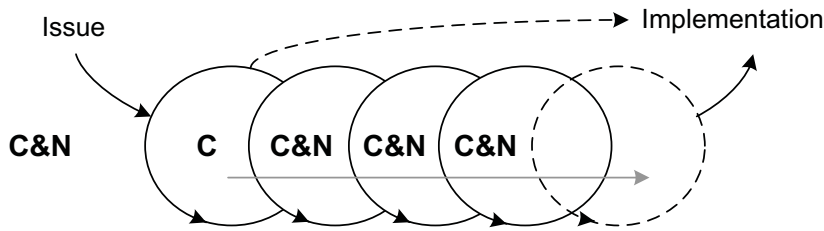

Figure 5.11. If a numerical model is required for implementing the results, the development of the conceptual model (C) and the numerical model (N) is iterative through the learning loop (LL), although the conceptual model always precedes the numerical model. The iteration continues as long as necessary, until both models correspond.

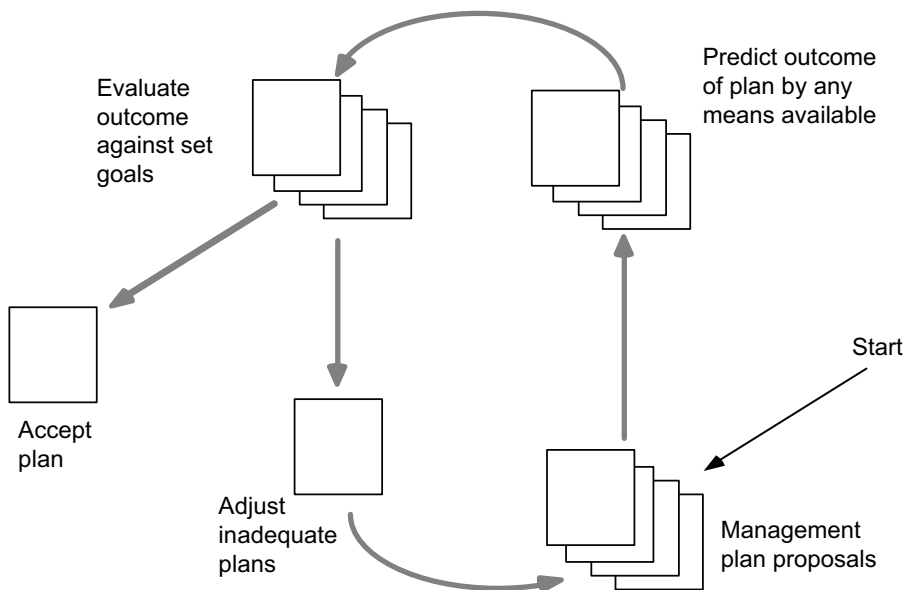

Figure 5.12. Summary of the implementation of models for predictions in planning and the adaptive management process (Sverdrup et al., 2002).

5.1.6 Example 5: Exploring drivers of unsustainability with Systems analysis

This example demonstrates how SA can be used to investigate a complex problem of sustainability. Specifically, this approach investigates causal chains to understand the dynamics of the system, although without the need to for system dynamics modelling. To start, knowledge is researched and compiled as proper background research is required to ensure the analysis is based on facts.

Introduction to the issue. Malthus (1798), the first to worry about limits to growth and sustainability, defined social and economic criteria for sustainability. However, at the time, the world was still very large and the human population very small, so most people did not feel the urgency. During the industrial revolution that followed Malthus' studies, the industrial potency increased fast enough to offset any scarcity, and no problems of limits to growth were seen as imminent. The issue only gained attention in early 1972 when the Club of Rome commissioned *The Limits to Growth* study, which was meant to stimulate precautionary thinking (Forrester, 1971; Meadows et al., 1972).

Similarly, the Brundtland Commission, a group assigned to create a ‘global agenda for change’ by the General Assembly of the United Nations in 1983, again put sustainability into the political focus: ‘Humanity has the ability to make development sustainable to ensure that it meets the needs of the present without compromising the ability of future generations to meet their own needs’ (Agenda 21 in Sweden, 1997; World Commission on Environment and Development, 1987). This statement, the heart of sustainability, leaves open for discussion how humans can achieve this goal. Robert Gillman extended this goal-oriented definition by restating the last part of the sentence above, referring to a very old and simple concept: ‘Do onto future generations as you would have them do onto you’ (1981).

In developing rules and criteria for sustainability, it is important to shape these as basic principles, and, as far as possible, free from value judgments. When defined this way, sustainability becomes a property of function and should be free of value judgments or cultural biases. The point of departure for defining sustainability resides in the laws of thermodynamics: mass and energy can neither be created nor destroyed and all systems will eventually reach a state of thermodynamic equilibrium i.e., the irreversibility of natural processes (Hougen and Watson 1947). As the above makes clear, defining sustainability is an on-going process with a long history.

In order for sustainability to become real, the concept must be filled with definite content and connect to observable parameters in the natural, social, and economic spheres. Sustainability or unsustainability will only have meaning when success can be measured quantitatively, relieving humanity from the need to define sustainability by referring to failures. The objective is to define the basic principles of sustainability so everyone can evaluate a situation or decision based on its sustainability. This text does not make statements about whether a certain activity or event can be identified as sustainable. This implies that the definitions must be precise, unique, and functional. It is also important that the rules of sustainability are applied in a realistic manner to avoid unfruitful dogmatism. It must be remembered that natural and economic sustainability must also be socially sustainable if sustainability is to have any practical significance for human society (Gilman 1990; van Pelt et al., 1995; O’Riordan 1988; Dryzek and Schlossberg, 1998; Eckersley, 1992; Ponting, 1993; Bossel, 2000).

Drivers of unsustainability. In *A handbook for impact assessment in the commission* and *A sustainable Europe for a better world, A European Union strategy for sustainable development*, the EU commission investigates how future policies will be evaluated with respect to sustainability. Several threats to sustainability are mentioned:

1. Global warming caused by human activity
2. Threats to public health from antibiotic resistant microorganisms, hazardous chemicals, and inadequate food safety
3. Poverty
4. Demographic shift towards fewer to work and more to support, emphasised by population increase in the older cohorts
5. Loss of biodiversity
6. Transport congestion

Each of these may need a considered comment. The EU sets this in perspective of their overall goals for society:

1. Protection of personal rights, freedoms, and obligations
2. Preserving peace, international security, and promotion of international cooperation
3. Safeguarding the security of the citizens
4. Preventing discrimination
5. Fulfil the requirements for a high level of social protection
6. Promote health and safety
7. Strengthening economic and social cohesion
8. Protect the environment
9. Providing for basic education, knowledge development, research, and cultural development

We have added some items that are supported in the EU policies but left off the EU sustainability issues lists. The threats are seen in perspective of the ability to provide these obligations, rights, and goals of society. The EU focuses on two major lines of analysis: regulatory failures and threats to sustainability or drivers of unsustainability that arise from market failures. After the issue of this report, the EU was criticised for ignoring the poor and developing countries. Since then, work on a second report has been in progress.

Market failures. Much emphasis is put on finding market solutions for meeting the goals stated above. However, this is only partial success as certain goals cannot be reached this way. Focus is now on the following market failures: externalities are not reflected in market pricing; provision of public goods and services of public interest; lack of or weak competition; imperfect information flow; and missing or incomplete markets.

Public goods are not fully provided by the market for several reasons such as unavailability of invoicing, supply failure due to limitations, and over-use. Frequently, over-consumption is the result of lack of connection to the provided good (Tragedy of the commons syndrome). Lack of competition often arises from lack of scale or lack of actors. Imperfect information flow can be caused by too little information, but increasingly also by too much information. The information flow in society is steadily increasing and therefore so is the supply of redundant information. The normal person has a very difficult time determining if the information received is adequate or excessive.

For example, postal services are easy to provide in a city setting, but the service cannot be provided to people in remote regions as easily (and inexpensively), especially if remote communities are responsible for the infrastructure and operating costs. Therefore, the redistribution system of the society must make up the difference, something a private company is not designed to do. This situation is similar to how rail tracks are operated as a public utility. The railroad tracks cannot be privatised without creating a monopoly, and no company nor society at large wants companies to build their own rail tracks. The rail tracks are a public good that lose their intended function once privatised.

Regulatory failures. Clearly, regulation is important for setting the rules of engagement in the private market sector. The public sector must, through its democratic institutions and executive organs, set the rules of engagement and rights, limitations, and obligations for the interactions between the private market sector, the individual citizen, and the public collective. These rules, obligations, and limitations are meant to guard against inadequate property rights, poorly defined targets and goals, unintended consequences, poorly applied regulations, failures of enforcement, and incomplete provisions.

Examples are apparent in fisheries. Fishing policies of the world are often based national needs rather than international effect as no international organisation is tasked with regulating fisheries. The oceans do not belong to any specific country resulting in a classic tragedy of the commons in spite of the fact that there is sufficient knowledge to successfully manage ocean resources. That is, the world lacks the institutions, political will, and structures for a global overview of the problem that will lead to effective regulations.

Regulatory failures are also apparent in unemployment regulations in some countries. For example, unemployment pay is so good that it is more profitable to remain unemployed than work. That is, the unemployed have been captured in the policy: the policy meant to help the unemployed find a new job promotes unemployment.

Attitude failures. In addition to the market failures and the regulatory failures mentioned above, there are attitude failures in groups such as lobbyists, political parties, academics, or government. Discussion of attitudes is difficult because the very concept discussion of attitudes is often used for political purposes

by totalitarian regimes (e.g., North Korea, Cuba, China, Zimbabwe, and the previous Soviet Union). Attitudes are embedded in the cultural heritage, social norms, and behaviour and form essential parts of the human social systems. Prejudice is a common attitude failure, and many people are not aware that they hold a prejudice even if it is obvious to others. Under normal conditions, change, albeit slowly most of the time, is only apparent in retrospect. In a healthy society, change is steady and recreated as a steady rate, most of the time with a net gain, resulting in an increasingly richer culture. In retrospect, most efforts to freeze cultural heritage generally end in disaster. Two of the most important tools for changing attitudes are education and mass media.

Attitude failures are present everywhere. For example, the spread of contagious diseases such as COVID-19 have been amplified by failures in attitudes that lead to the dismissal of scientific experts. Willing to offer bribes or take bribes is another attitude that can create problems and override sustainability limitations. Attitude failure could be lack of accountability for damage that is not readily visible or damage that is passed to the future on purpose. An attitude failure would be failure to pay for externalities even when these externalities and their effects are known.

Further thoughts. More fundamental threats that create drivers of unsustainability can be identified:

Discounting increases the possibility that there will be future damages that will need to be addressed. In many situations, answers derived from this appear to be obviously wrong.

Long-term activities above total available carrying capacity decrease the likelihood of future survival.

Problems associated with norms and ethics can result in abusive expressions of power, prestige, vanity, opportunism, prejudice, and greed.

These threats are more fundamental drivers behind many of our problems and symptoms associated with lack of sustainability. The inferior value of the future is a most serious problem caused by our present paradigms for evaluating policies and economic projects.

Economic discounting emphasises the use of opportunities in the present, and underestimates systematically the value of future options and the effect of these actions on the unborn. In the same way, damages caused in the future are much less valued than those incurred instantly, as this view de-values long-term thinking and responsibility by passing problems to future generations. Discounting the future is a symptom of self-interested ethics as sustainable investments have a long time horizon, which makes it difficult for people

to justify sustainable investments in terms of the pay off. The result is that potential losses are ignored the longer one waits, deferring responsibility and promoting a belief that precautionary principle is unprofitable, as the maxim 'do now and pay later' is adopted. Discounting the future often leads to opportunism and decisions that assume the worst case scenario will never come to pass, at least during the lifetime of the decision-makers. For periods of 30 years and more (say 100 to 500 years as the case for forestry, water-power facilities, land erosion, or global climate change), discounting would in hindsight lead to the wrong decisions and often would have been outright unjust to coming generations.

It is quite easy to show that many essential technical developments and infrastructure would never have come into existence if discounting had been consistently practiced. That economic discounting is inconsistent with the precautionary principle is a major problem that must be solved. Discounting also takes place over distances (Daily and Ehrlich 1992), even if this is not explicitly expressed in quantitative terms. Domestic assets are generally valued at higher prices than comparable ones in distant lands. Japan uses timber taken from virgin forests where unsustainable practices are used to harvest the trees, whereas Japanese forests are protected by strict policies. The government of Germany made little effort to control industrial emissions that were causing damage in far-away countries in the 1970s. Only when significant forest damage was documented in Germany itself did the German government take serious action to curb emissions (1991). There is also a problem of standards of comparison related to economic distance rather than geography. Population numbers far above national carrying capacity also represent a severe problem, since there are no simple ways to reduce populations in socially and democratically acceptable ways. Because of the long lag times, essential stocks for long-term survival risk running dry before natural attenuation of the cause can ameliorate the situation. This could result in reduction in the carrying capacity, increasing the need for adjustment of the cause. Thus, addressing carrying capacity issues will help prevent morally impossible situations.

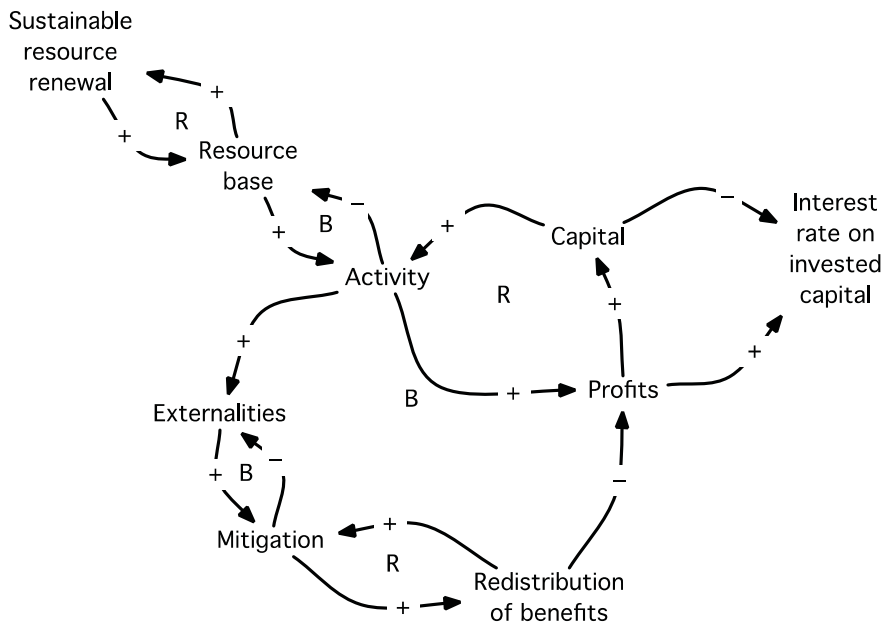

Figure 5.13. Inclusion of externalities requires an external transfer system for redistribution of the cost of externalities back to the cost of ownership.

The persistence of an unsustainable situation is a major threat in many cases, so the path to sustainability is obviously important. Remaining for long periods outside the sustainability area may affect the sustainability limit, changing the position of the limit. Going quickly from unsustainable to sustainable may result in a larger remaining sustainability capacity than waiting for the correction. The cumulative excess stress on the system caused by non-sustainability cannot be larger than the finite capacity of the resource reservoir used. At the point where the resource reservoir is emptied, strict sustainability on the lower level will be immediately enforced. In extreme cases, the new low level may be zero, implying obliteration of the system. The capacity to extract has increased with technological development (Sverdrup et al 2013), which has the deceiving effect of offsetting the feedback from resource exhaustion.

Linear thinking can make it appear that resource stocks are increasing when they are actually decreasing as the relationship between observed extraction success and resource size cannot be evaluated properly using linear logic. Therefore, little warning is available when the stocks crash, resulting in a shortage in a very short span. This phenomenon has been observed in fisheries. Improvements in catching technology have quickly increased the number of fish caught, making it appear that the fish stocks are increasing when in actuality they are more rapidly being depleted, an trend that goes unnoticed until the stocks crash. The result has been total collapse of these fisheries without warning until the stocks were fully depleted. This situation seems to be occurring in oil extraction as estimates of remaining resources are based on extraction as the result of improvements in extraction technology rather than the actual remaining stocks. Thus, linear extrapolation and linear statistics have so far mostly been a fool's errand. When looking for drivers of

unsustainability, we need to be very careful to distinguish between symptoms, problems, causes, and drivers. We also need to critically ask for what, for whom, and where? To confront the sustainability problem, we need to find the cause as this information is needed to find a solution. We need to find the unsustainable situations, distinguish these from their symptoms and from the problem before attributing causes and drivers that sustain the problems.

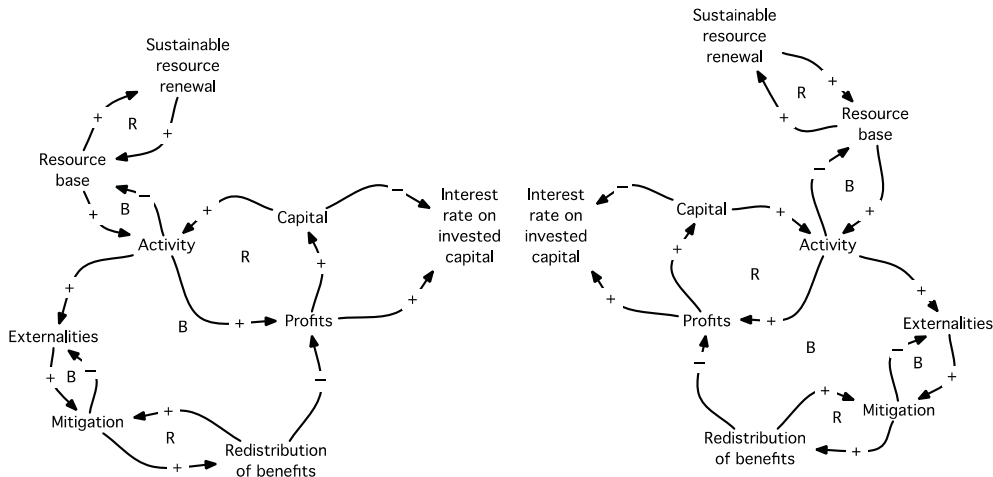

Figure 5.14. If the whole economy is one sector only, then it becomes evident that the financial interest rate in that society is the ratio of profit to capital stock in the system. This makes it evident that estimates of profitability of activities dependent on resources from natural systems, cannot use a financial interest rate which the system cannot sustain by its carrying capacity.

Agriculture and industry. In Europe, the agricultural sector over-produces food. This leads to a number of serious problems, including water and air pollution. Overproduction of certain types of agricultural products in large amounts leads to waste. Dumping of cheap surplus food in neighbouring countries destroys their agricultural markets and spikes unemployment. These newly unemployed might have to immigrate, often illegally, to countries that need workers, creating tension between the local work force and these foreign job seekers. Overproduction negatively impacts the country that produces the surplus food, is unjust to the farmers in the countries that receive the surplus food and drives social instability in the countries that produce and receive the surplus food. The example shown in Figure 5.15 illustrate the severe drawbacks of operating with closed arenas, selective favouring, and asymmetrical rules.

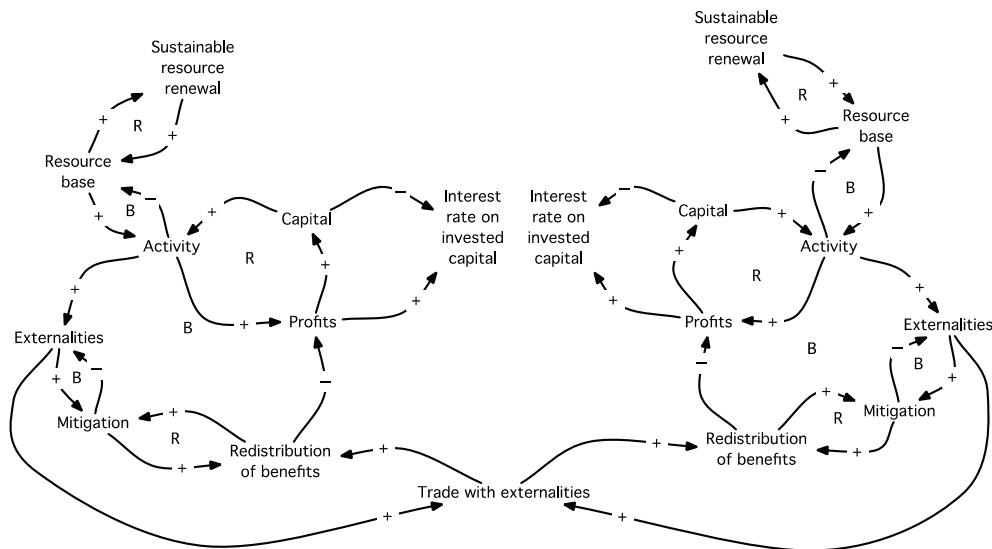

Figure 5.15. If trade of externalities are permitted, this may shift competition relationships between actors in the market. Care must be taken to set limits for trade within the bounds of the carrying capacity for those particular externalities.

Industrial production has largely moved from the west (e.g., Europe and the USA) to the east (e.g., China, Vietnam, India, and Indonesia), resulting in cheaper products, allowing most people of the world to experience a type of consumerism that was once restricted to the riches countries in the world. These countries have entered into free trade treaties of different kinds, efficiently removing barriers to trade and movement of goods. Side-effects are slowly starting to show up. In the countries where the production was previously located, production cost was higher because of all the social externalities had been added and to a large degree these were actually paid. The transfer systems for externalities are still in place, but the income from those resource reallocation systems are now dwindling. In the new countries, production is not burdened by such costs. Prices, including many externalities, are being compared with costs not including externalities. That is, these social costs (externalities) are pushed off to the future. The costs are probably been charged, but they are not paid, just added to a future debt. This arrangement is probably not socially sustainable, as in the long-run this arrangement creates a social debt that somehow will have to be compensated for in the future. For free trade to work properly, very carefully designed rules are required to ensure full accountability.

Financial markets. When an investment is considered, the net profit performance is evaluated. The net profit is evaluated against what profit would be if the money is invested elsewhere. Through our efficient financial system of banking, it is possible to invest anywhere, even without significant personal involvement. Thus, an alternative profit rate can always be obtained. This works fine in principle, except for one problem. Many of the alternatives generating the alternative profit arise from operations where part of or all

of the externalities have been sent to another system or deferred to the future. Sometimes the alternative profit derives from extraction of a non-renewable resource or from extraction above the regenerating rate. The result is an interest rate that requires excluding substantial parts of the externalities, as illustrated in Figure 5.13. By definition, the profits of an unsustainable project are not fit for comparison with profits derived from a sustainable one within the context of sustainability for the whole society. It may be beneficial to the individual, but the contribution to the good of the whole will be less than the damage caused by the unsustainability to society and its survivability as a whole.

Let's consider a thought experiment (Sverdrup and Svensson (2002a,b); Sverdrup et al., 2002). Imagine that the only industry in the world was production of wood from trees. The forest grows sustainably an average of 3.3% of standing stock every year. The limiting factor is the natural nutrient supply capacity. Thus, an alternative investment in forestry would be in a forest in another location with approximately the same growth rate, so the alternative profit could never be more than 3.3%, because it all depends on how much wood the forest will be able to sustainably grow. Demanding a profit of 5% would imply that we would have to take the whole sustainable growth plus enough to arrive at 5% growth from the reserves ($5\% - 3.3\% = 1.7\%$). Thus the stock of limiting resources will decrease by 1.7% every season. In fact, we can probably make the forest actually grow 10% per year in the short term, even if that cannot be sustained by nutrient supply in the long run. Of course, when we scale this up to a mixture of trades and countries, the system becomes less easy to see, and the sustainable interest rate can be very difficult to estimate. This is illustrated in Figure 5.14, which shows that interest on invested capital is a system output. The conclusion made from Figure 2 is that externalities must be included in the system. This requires an external transfer system for redistribution the cost of externalities back to the cost of ownership. As illustrated in Figure 1, this is the interest rate that must be compared in sustainability assessments before investment. The maximum profit without externalities is in this respect less useful, as it measures the maximum profit speed of the system, not sustainability.

If trade of externalities is permitted, this may shift competition relationships between actors in the market (Figure 5.15). Care must be taken to set limits for trade within the bounds of carrying capacity for those particular externalities. At present, the prevailing economic paradigm is based on the assumption that the world is endlessly large, an open system and with free demand and supply market for all goods and services. It is not very difficult to show that these assumptions are no longer true (Ainsworth and Sumaila, 2002; Norgard and Horworth, 1991). When world's population was 1/20 of today (100 to 300 million people), the world was for all practical purposes unlimited. There was always new land to colonise and new resources to exploit. Furthermore, use was much smaller than resource potential. The full use of alternative resources was possible. Scarcity existed very much because

of extraction rate limitations, but world resource exhaustion was not a serious threat. Unsustainability was then much more a social phenomenon, and some significant elements of unsustainability from then are still present today. Today, the world is finite, and humans have the capacity to exhaust many resource reservoirs within a single human generation.

The earth is indeed a closed system with respect to its carrying capacity, and there is no longer the possibility to find alternatives for all resources in decline. Many items essential for society and humans have no known substitutes. Still, modern economy operates on the assumption that there is such substitutability. This is a major and dangerous flaw of present economic theory, making large parts of the theory invalid when such limitations are encountered.

The challenge is to adapt our economic system to cope with this reality (Perman and Gilvray, 1996; McIntosh and Edward-Jones, 2000). Modern economy education needs much stricter adaptation to reality and important parts of economic and political paradigms need to be replaced. In significant areas of the world, the human populations have started to decrease; this pattern will become more widespread as resource limitations eventually set in. At that point, humanity will no longer be able to maintain the idea of unlimited economic growth; thermodynamics will make sure of this. Growth and development will have to be redefined to quality development rather than volume increase. We must learn how to develop quality and produce wealth in a dwindling market volume caused by significant long-term population decrease. Even the concept of wealth may have to be culturally reinvented from a biology-based concept of physical hoarding of nutrients and amassing of sexually-oriented decorations to something more sophisticated.

We must carefully manage and recycle essential finite resources that have no substitutes. Our present economic system must adjust to these realities even though this adjustment will be difficult.

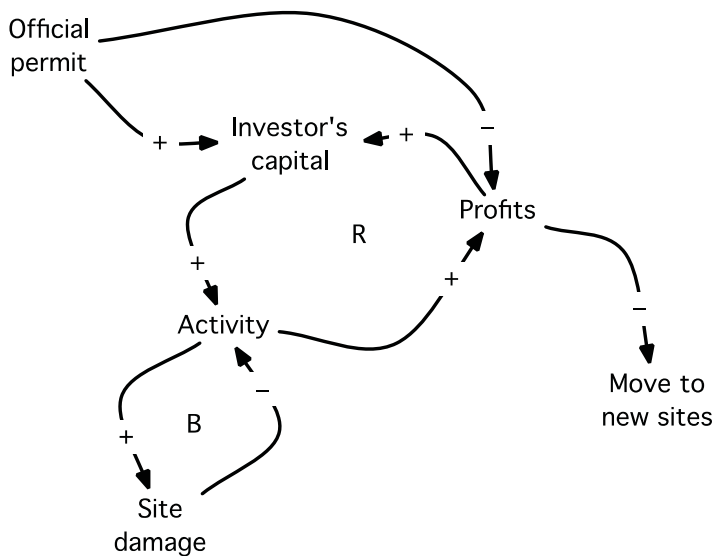

Figure 5.16. Shrimp farming in far east Asia operates at present with very little balances and checks. By jumping to new sites whenever the presently used site deteriorates from damage, more and more profit is made at the cost of more and more coastal mangrove sites damaged. The system is unlimited in its progress until the resource is exhausted. Net effect: Stepwise increase in cumulative profits until the resource is consumed, steadily increase in the cumulative damage until all the resource is consumed.

Social sphere. Important drivers of sustainability are embedded in human group behaviour and competition. Pride, vanity, prejudice, envy, avarice, and fear affect behaviour more so than logical reasoning. These are in general embedded in all humans, regardless of culture, gender, or ethnicity and have explanations in evolutionary biology. These are among the most important drivers for unsustainable consumption of resources on the personal level. Much of our behaviour is embedded in our cultural heritage, attitudes, and ideologies. Such traits are very difficult to change. Thus, the production of commodities associated with display of status, rank, and vanity, (luxury items, items for power display, items for sexual competitiveness, items for enduring idleness, items for group identification, etc) creates an enormous market. The production of these consume a disproportionately large part of our resources as compared to what is required to support life and normal well-being. How much of this are we entitled to? Ideologies and cultural heritage are dynamic concepts. They must steadily be updated and improved, and no harmful behaviour can be excused because of cultural heritage, religion, or ideology. Performance in the field is what counts, not pride or prestige. In the worst cases, ideologies that are not updated may end up as so inadequate and in conflict with reality, they might have to be scrapped completely.

In a society, taxes and obligations are levied to cover the production of public rights, goods, and services. Should the public institutions fail to deliver the goods promised in return for the taxes levied, then the trust capital will be eroded. Should the situation persist for a long time, then the social capital may be eroded to the point where parts of the society or state deteriorate or even dissolve. The legitimacy of tax levitation is at this point eradicated;

the population simply sees no return worth the cost applied. This is what happened to the East Germany and the Soviet Union, where the population simply lost faith in the statehood project and organised themselves into other projects. The individuals perceived that the public institutions failed to deliver services and public goods considered to be essential, amplified by the visibility of more successful projects elsewhere.

In the social sphere, the solution to such a trust crisis is obvious. The social contract between the public collective and the individual is always a mutual understanding that relies on the informal contract being kept to a reasonable degree. Frequently, the individual will conduct an informal cost-benefit⁴ analysis of whether the contract remains advantageous, and if not, will leave the project if possible (Azar et al., 1996). In a globalised world with increased transparency and mobility over larger regions, all politicians would do well to realize that their monopoly on their national populations is quickly dwindling.

The example of shrimp farming in Vietnam. At present, it has become popular to invest in shrimp farming in the coastal mangrove forests of Vietnam. This is highly profitable, but the activity is done in such a way that the site is actually ruined after some years, and profit declines. Typically, sites are abandoned for sites further up the coast. Presently, there are substantial coastal mangroves sites left, but these will not last. This situation is obviously unsustainable.

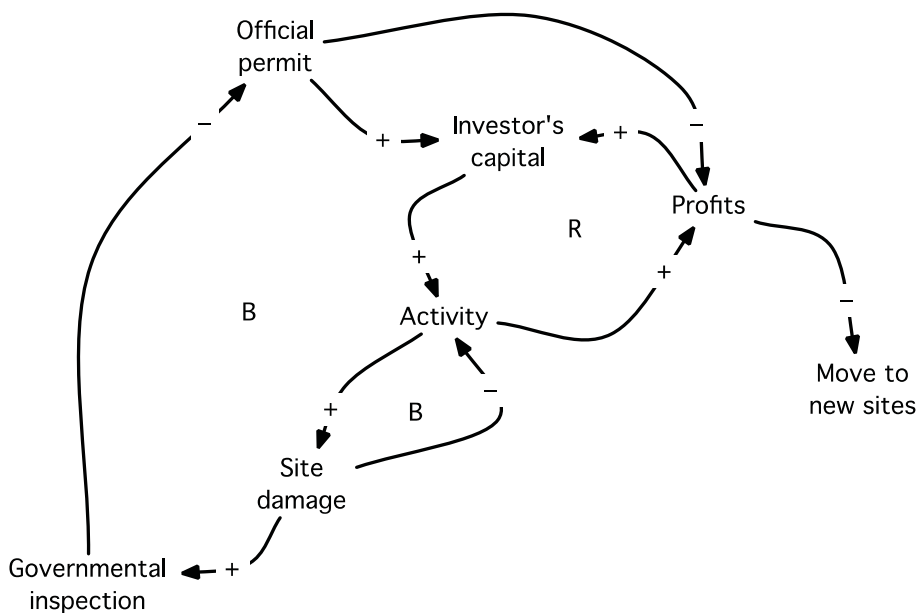

Figure 5.17. Involving the common sector to limit the private activity to consider limitations in the resource may help limit damage to the stock of sites. Several policies may be adapted.

⁴ The benefits being physical (resources, possessions, money) and social (affection, social standing in the hierarchy, power, responsibilities and duties, sexual accessibility to procreate, parasitising, etc

The present situation. Let's apply a tool from SA to the problem, causal loop analysis, and see what we can make of this situation. This has been displayed in a series of diagrams (Figure 5.17 – Figure 5.20). In a causal loop diagram, the relationship between each of the system's components are investigated pair-wise by asking whether parameter A is changed. Is there (a) a causal connection (an arrow) to B? And if so, does B respond to an increase in A with an increase (+) or a decrease (-)? The result will be a structure of arrows, some constituting loops; this is the system diagram. When completed, the diagram is used to see if a change in one parameter is seen in other parameters. This approach is used to qualitatively investigate and understand the behaviour of a system. The example of shrimp farming as it is presently practised is shown in Figure 5.16. The private investor engagement leads to more activity. An increase in activity leads to more profit as well as more damage. More profit leads to more investor activity. There is only one loop in the system, the investor-activity-profit-investor loop. An increase in investor activity leads ultimately to further investor increases. When increase leads to increase, this is called a reinforcing loop (R).

Introduce governmental regulations. This is an example where we can detect that essential system structures are missing, and this must be amended before the system can be brought on a path towards sustainability. Good governance is missing in this particular system. We will add it to the system as governmental concern aroused by the attention of incurred damage. This may let the governmental structure revoke shrimp farming permits or impose an environmental taxes, reducing the profit if too much damage occurs. Thus, we must add to the diagram. In this amended system, an increase leads to the activity-profit-investor loop, but also activates the investor-activity-damage-government-tax-profit-investor loop. In the latter loop, an investor increase comes back as a decrease. This is a retarding loop, applying brakes on the system (B). The more the reinforcing loop speeds up, the harder the brakes. The result is that there will not be an increase forever, but a levelling off, a stable level. Optimally, the tax revenue would be used for ecosystem restoration. This has been shown in Figure 5.17. Here, both the private side of the economy and the common economy (state) are involved in mutual feedback. Now two balancing loops counteract the single reinforcing loop that was active earlier.

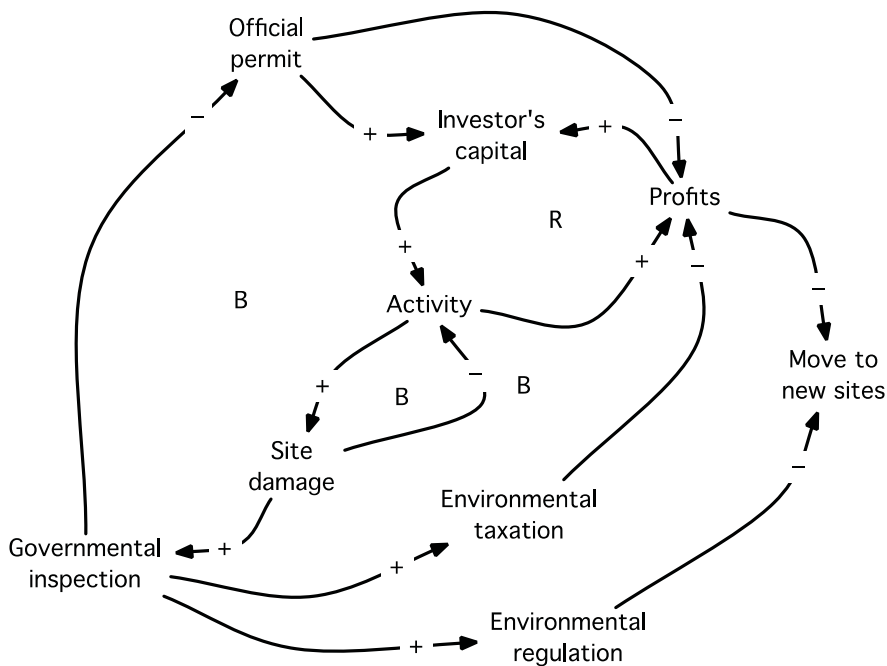

Figure 5.18. An environmental tax may be introduced proportional to the environmental damage caused. The tax can be used for environmental restoration or pollution prevention efforts. The tax can be seen as a way to pay for externalities as the governmental body carries the responsibility for using that revenue for externalities of the taxed activity. Net effect: The damage is reduced and stabilises and the profit stabilises at a lower but balanced level.

Introduce damage rights trade. Figure 5.18 illustrates the amended the system diagram to include a trading system for environmental impact permit or the right to do damage. In our system, the partner to the right is selling right to do damage to the left side. This trading introduces three loops in each subsystem: three limiting (B) loops in the buying system and one reinforcing (R) and two limiting (B) loops in the selling system. This arrangement introduces an asymmetry in the competition properties of the companies. The trade allows one actor to not use the quota for causing damage and therefore increase profits. The actor producing more damage than the quota must give up part of the profit to increase quota for the damage. The actor causing the least damage will be able to compete better. Many economists favour trading as a remedy for solving environmental issues. Will it solve the problem? Can we solve everything in the private sector? Not entirely, as the private sector does not own the whole system, so the common sector must also be a partner.

Thus privatising everything or letting the community control everything represents extremes that deny the facts on the ground. Both spheres are present, and any denial of any sphere will only add new drivers for unsustainability by excluding participating components or stakeholders. Leaving it solely to the private sector would only introduce another driver of unsustainability as nobody in charge of the commons would be active and vice versa.

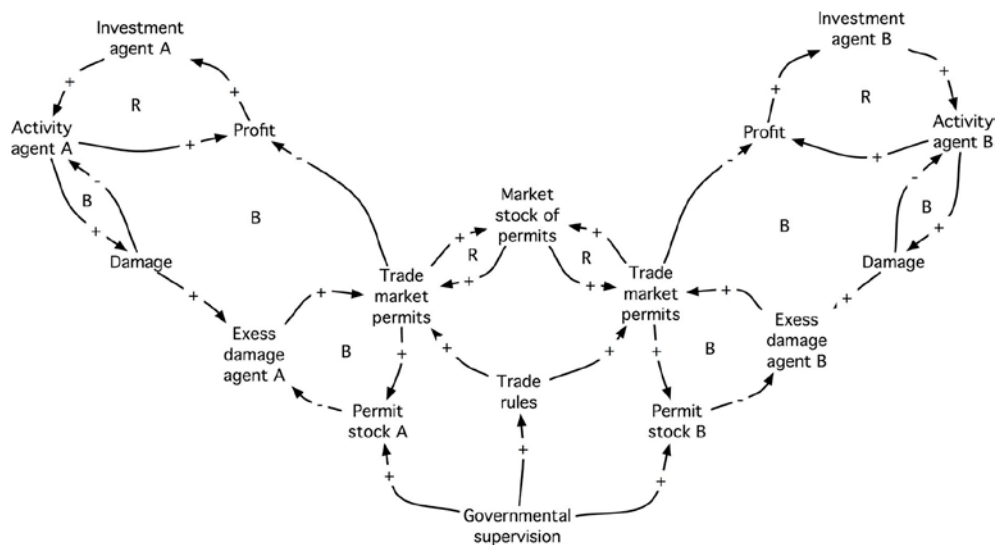

Figure 5.19. Can we solve the problem by environmental damage trading in the private sector? Again, we will use systems analysis methods. It is evident that the private sector does not own the whole system, so the common sector must be a partner. Trading of damage permits may enhance the regulatory effect already there from the effect on damage to activity and more strongly promote an equalised damage level. But as long as new permits are not regulated, the site-hopping will continue. The net effect: The damage level stops rising and stabilises. The entrepreneurs continue hopping up the coast to find more profitable fishing areas. The private sector is coloured black, the public sphere green, and the trade red. The conclusion must be that the market cannot solve the problem alone.

Combine damage rights trading and governmental regulations. However, trading of damage rights together with actions by the community may enhance the regulatory effect and strongly promote an equalised damage level (Figure 5.18). The implication is that more effort needs to be put into defining what constitutes the private sphere and the community sphere and into drawing a realistic picture of how these spheres interact. The best feedback and caretaking of the business, investors, and commons are obtained by a combination of community and private mechanisms. However, the trade marketplace is actually in the commons and the rules should preferably be under democratic control. A combination of private trading in an official market (part of the commons), community regulated laws (permits), and incentives (taxation of damage) gives the best control of the process, optimising profits and paying for damage. This is illustrated in Figure 5.20 where the system diagram has been revised to add the new components and more limiting loops, combining the system in Figure 5.18 and Figure 5.19. The net effect of combining trading and a regulatory approach is that the damage level stops increasing before slowly decreasing. Private profit stabilises at a sustainable level when the feedbacks have been adjusted to correct strength.

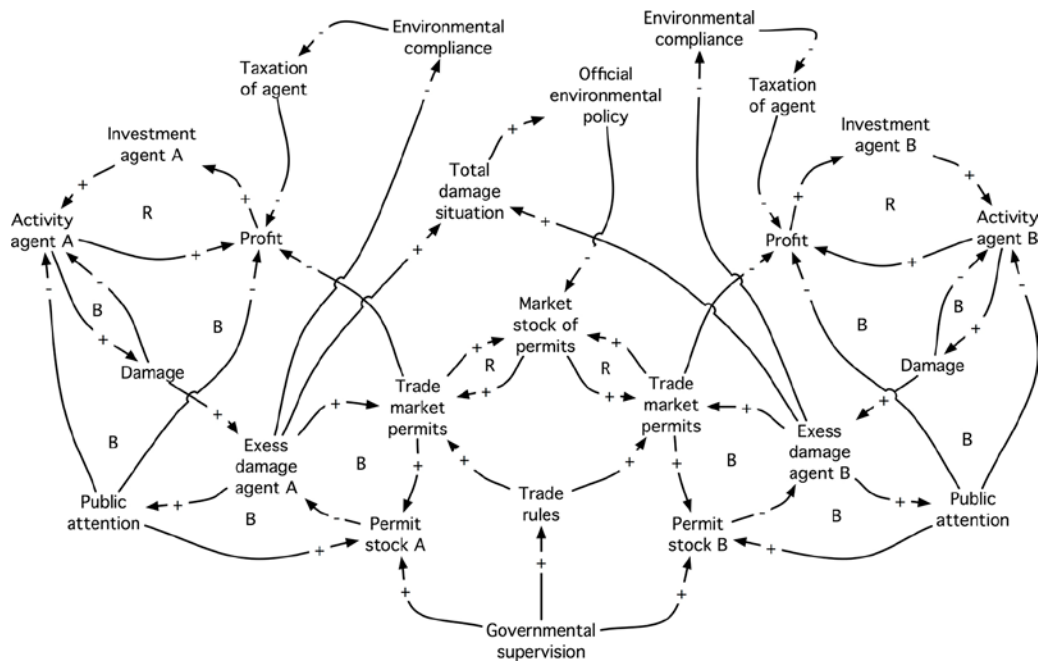

Figure 5.20. A combination of private trading in an official market (part of the commons), community regulated laws (giving or withdrawing permits), and incentives (taxation of damage) gives the best control of the process, optimising profits and paying for damage. The site hopping is controlled and the activity at each site is controlled to stay inside sustainability limitations. The community sector is shown in green, the private sector in black, and the actions of trade in red. The net effect: The damage level stops increasing and slowly decreases. Profit stabilises at a sustainable level when the feedbacks have been adjusted to correct strength. The total coastal resource is not exhausted.

The approach may be used to investigate further possibilities in the system. The government may start diverting tax collected for externalities to other purposes, dumping their responsibility. Tax may be imposed on the trade to generate payment for the externalities transferred from one region to another. Money may be used for corrupt purposes such as bribes for permits rather than paying taxes on damage.

Conclusions. To solve the problem of unsustainability, both market solutions and official regulations set by institutions are required. This can be seen as the market may provide the actors, but the arena and the rules that prevail must be set by the society in democratic fashion to secure justice, social sustainability, and prevent abuse of power. Alone, these factors do not have the ability to ensure sustainability. To address sustainability is not easy, but it is not impossible. However, success will require seeing the whole system. Each part may in itself seem legitimate, whereas the integrated effect of the whole remains unacceptable. The analytical task is complex, difficult, and often non-linear because the complexities of the feedback loops make the effort far from straight forward. Non-linearities often produce outputs that may be seen as counter intuitive system responses. Many tools used for sustainability assessments are at present static or linear. Although linear approaches may work initially, they certainly will not work in the future. In this text, we have

illustrated the importance of using SA tools to reveal causal links and feedback loops in a system. Understanding the drivers of unsustainability is as important as understanding sustainability.

5.2 Using causal loop diagrams for policy analysis

5.2.1 The example of agriculture

The diagram shown in Figure 5.21 was developed as a part of study focused on sustainable agriculture. The diagram was used to explore policy options for enhancing production volume and production efficiency.

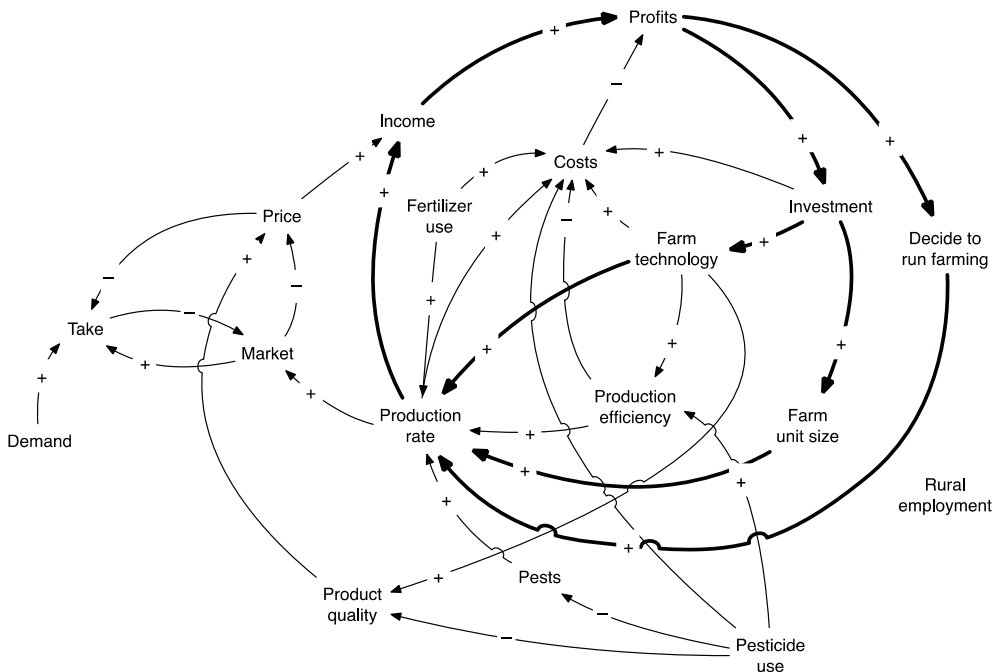

Figure 5.21. Simplified diagram of the operation of a farm.

The diagram describes how a farm is run as an enterprise. The thicker arrows show the reinforcing loops in the system. The production is driven by the decision to run the farm to make profits. This cycle is reinforced by investments and farm technology. There are also a number of balancing loops caused by costs and pests that can decrease the crop. The diagram allows the investigation of how policies affect the system by including them in the causal loop diagram. Figure 5.22 shows the same diagram as in Figure 5.21, but with sustainability limitations (green lines), taxation interventions (red lines), and policy interventions (purple lines).

5.2.2 The example of population size, women's rights, and the society

Figure 5.23 shows a causal loop diagram linking the social conditions for men and women, the degree of emancipation of women, the efficiency of service provision by society, democracy, and corruption with the birth rate. The birth rate is controlled by many factors that can be affected by policy. The red lines are different policy system entry options that have been evaluated when lowering the birth rate is the success indicator. Figure 5.24 shows another view of the birth rate, global population size, economic prosperity, and education. The red lines are policy interventions intended to create system state change. For this kind of analysis, a quantitative model is not really necessary, so many of the policy conclusions are based on qualitative assessments only.

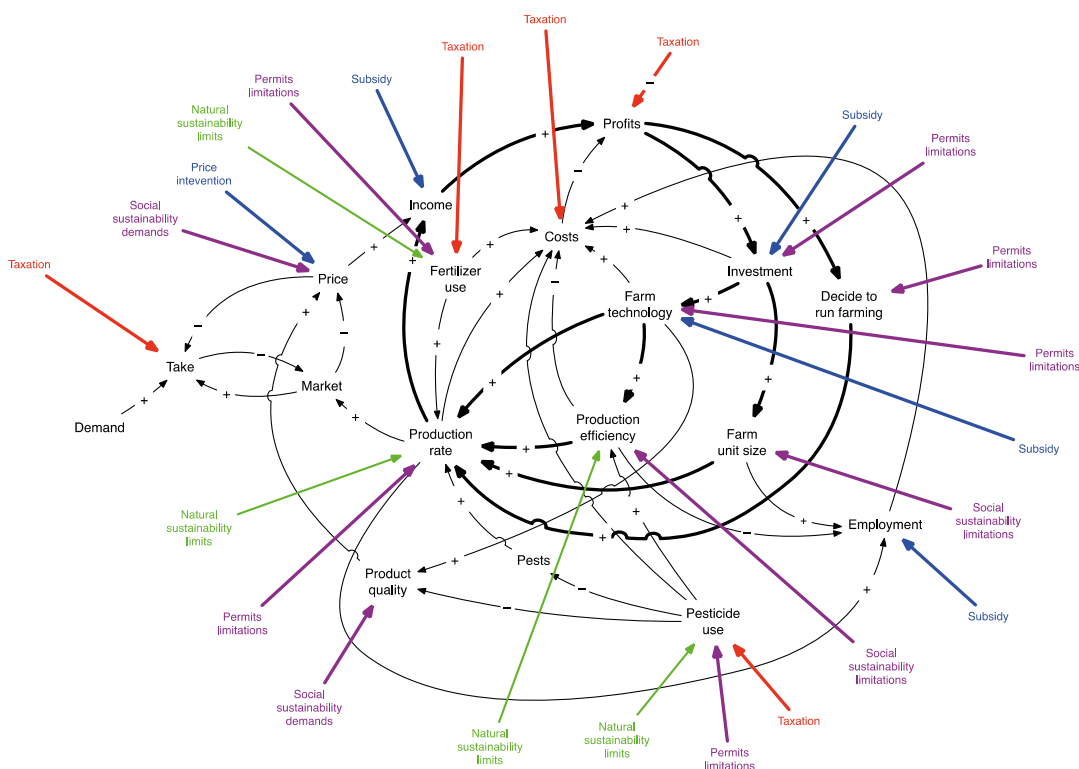

Figure 5.22. The same diagram is the same as in Figure 5.21 but with sustainability limitations (green lines), taxation interventions (red), and policy interventions.

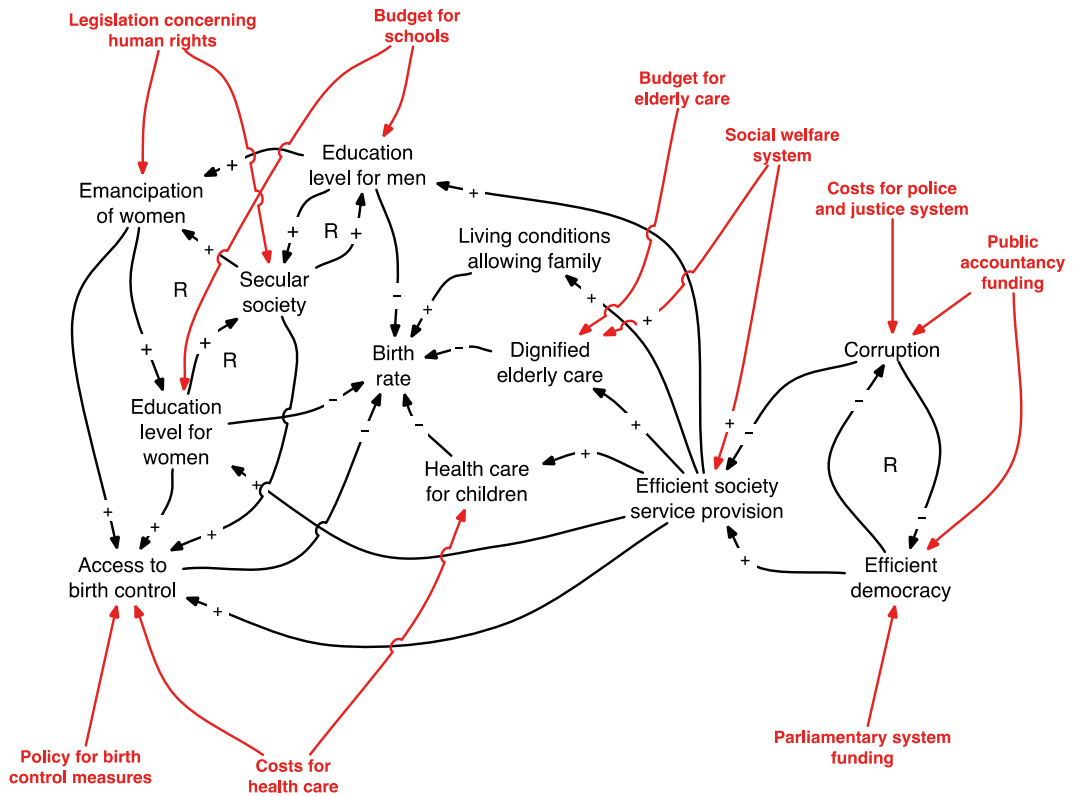

Figure 5.23. Causal loop diagram linking the social conditions for men and women, the degree of emancipation of women, the efficiency of service provision by society, democracy, and corruption with the birth rate.

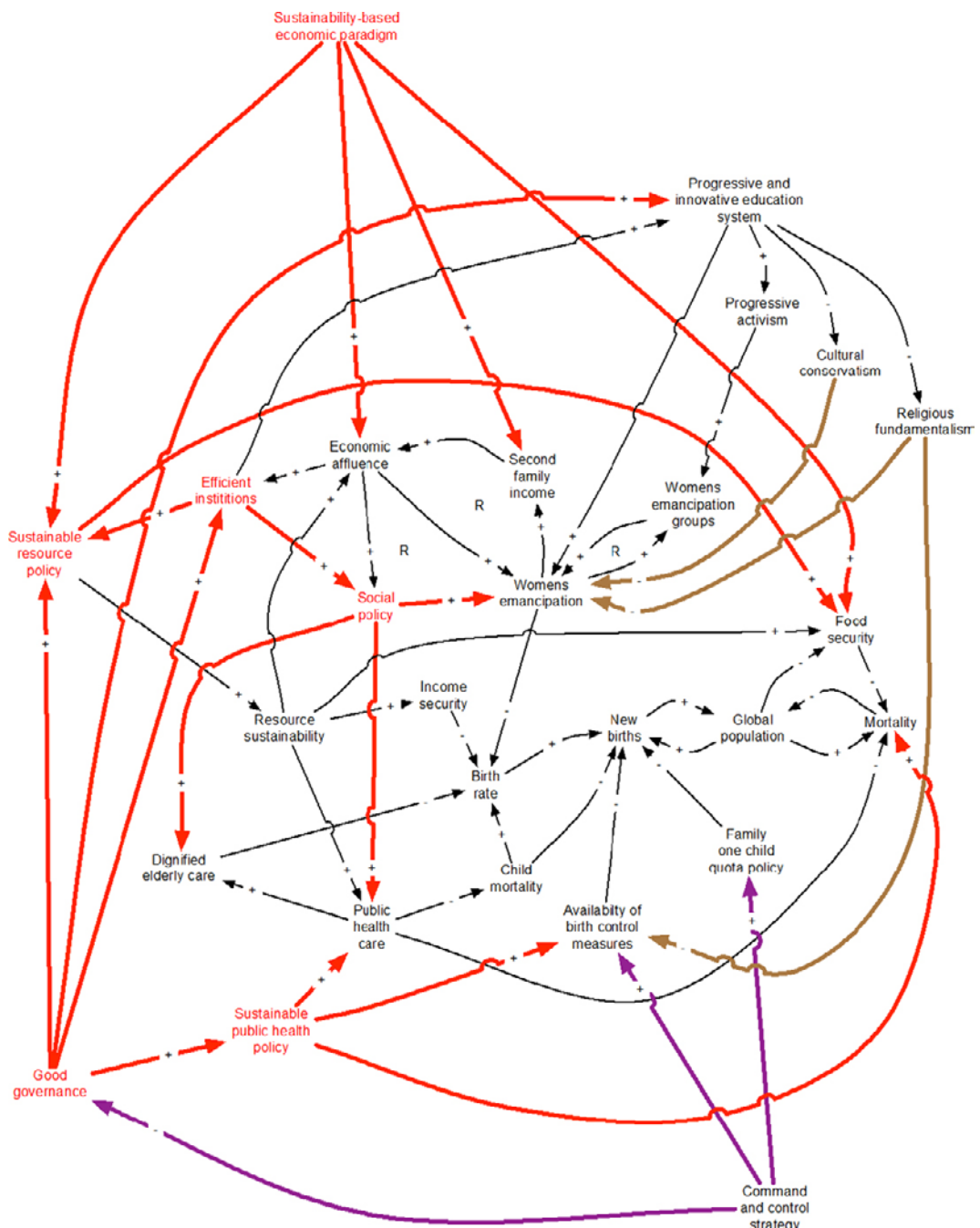

Figure 5.24. Another view of the birth rate, global population size, economic prosperity, and education. The red lines are policy interventions created for system state change.

Thomas Piketty's book *Capital in the twenty-first century*⁵ and Acemoglu and Robinson's book *Why nations fail*⁶ provide some information needed to draw the diagram in Figure 5.25. However, these books do not cover the whole diagram and their topics overlapped a bit, but they complement one another with respect to the construction of the diagram. Literature reviews often start by looking for the logic of a text and drawing the CLD that represents the logic; as texts are added, a fuller picture of the CLD emerges. Once a fuller picture emerges, enough information is available to discuss the increasing inequalities in society, issues that both Piketty and Acemoglu and Robinson discuss. However, because neither Piketty nor Acemoglu and Robinson constructed the CLDs, many causalities were not visible to them, so their policy analyses are incomplete due to this lack of systemic overview. In the diagram, the red lines are the policy intervention possibilities and blue lines indicate equality, the target success indicator.

⁵ Piketty, T. 2014. *Capital in the twenty-first century*, Harvard University Press, 2014, 667pp, ISBN 978-0674430006.

⁶ Acemoglu, D. and Robinson, J.A., 2013. *Why nations fail. The origins of power, prosperity and poverty*. Profile Books Ltd, London. 529pp. ISBN 978-1-84668-430-2.

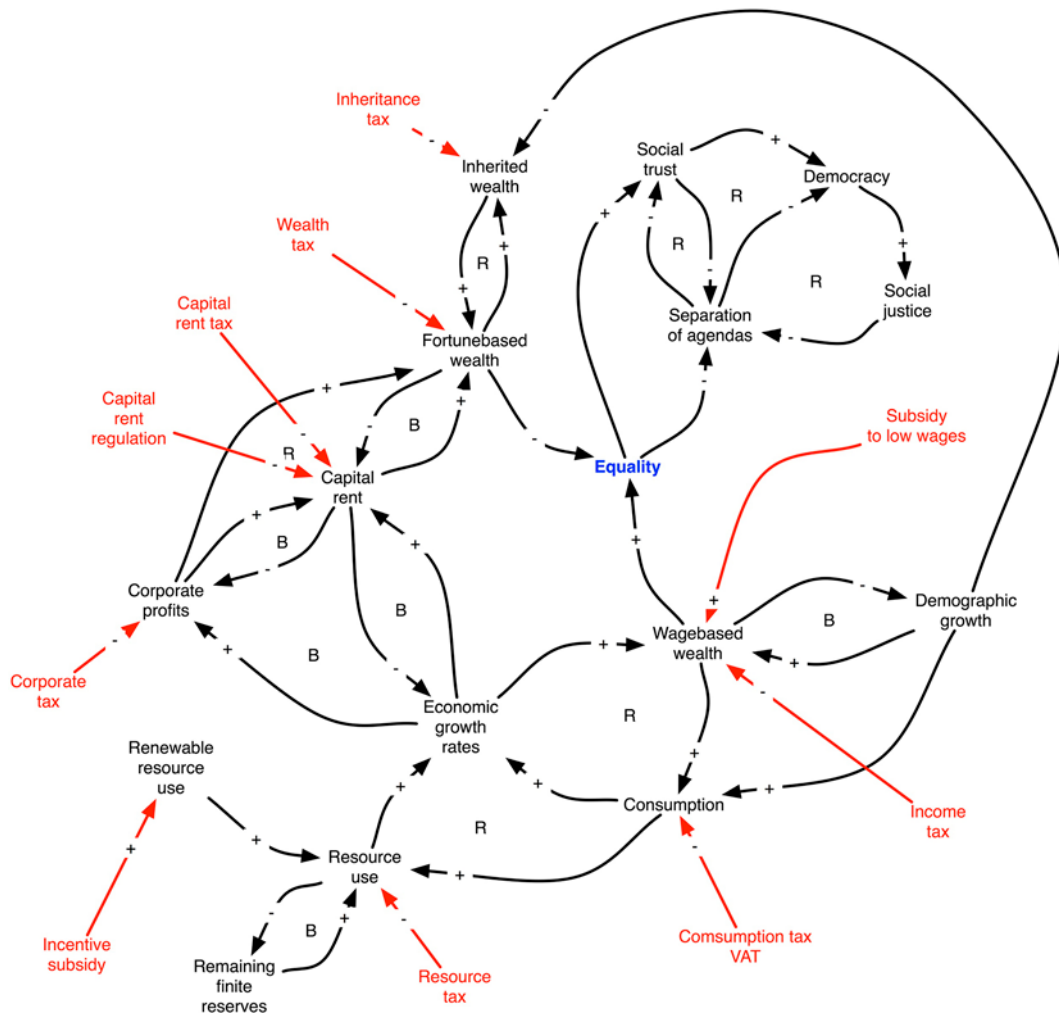

Figure 5.25. After reading Thomas Piketty's book *Capital in the twenty-first century* and Acemoglu and Robinson's book *Why nations fail*, we could draw the diagram above. Red are policy intervention possibilities and blue indicates equality, the target success indicator.

5.3 Standardised solutions

5.3.1 Applying generic structures and problems with best practices

There have been suggestions for using generic structures within system dynamics research (Senge, 1990; 1994; Wolstenholme, 2003; 2004). Generic structures such as the TYST archetype can explain a specific problem behaviour that manifests different systems. Generalisation of this kind works reasonably well if the causality structure within the problem is known. The risks associated with using archetypes arise when problems are assumed to behave according to a certain archetype before any proper analysis of the system. Archetypes support identifying the problem behaviour and forming the system boundaries around the problem but cannot be used to replace the structure that is unique for that particular problem. Archetypes can only describe a generic behaviour within the problem on an aggregated level. In the details, several archetypes could be inhabiting a system on different levels (Wolstenholme, 2003).

However, the presence of an archetype requires a sufficiently rigorous analysis to establish it as a fact. Therefore, the model builder must have a very good knowledge about the problem and its boundaries as well as what questions to ask. The questions posed for the problem must fall within the system boundaries of the problem statement (the clarification phase in the group model building helps solidify this process).

Therefore, the purpose of the model must fully overlap with the problem statement to successfully address the correct questions. That is, ready-made model solutions are not always adaptable for every problem as the model building process is unique for every situation, even for related problems. Therefore, the advocacy of best practices, which has been initiated within the system dynamics research (Hines, 2002), runs the risk of supporting shortcuts during the modelling process. Performing shortcuts is similar to assuming that structure and behaviour are generic between problems and the same solution for one problem can be applied to another. There is a risk that the causality has not been sufficiently mapped and therefore a generic behaviour may in fact be non-existent. Shortcuts limit the use of system boundaries since little effort is made to verify that the chosen behaviour represents the problem and its boundaries. The concept of best practices is a general utilisation advice with the aim to accelerate and simplify the modelling process by offering shortcuts in the analysis of the problem and its symptoms. The risk with the general utilisation advice is that the problem that the general utilisation advice intends to address may in fact exist outside the sphere of the general utilisation advice (Figure 5.21).

Applying the TYST archetype through the general utilisation advice on certain behaviour can result in wrong interpretation of the problem since the archetype behaviour can only be discovered when the two interacting levels that create a behaviour have been detected, which is only possible when alternatives have been thoroughly tested. Therefore, understanding archetypes requires advanced understanding of how they emerge and interact within the system. The general utilisation advice works only if the advice fits the problem statement. The use of general utilisation advice can enhance the understanding of archetypes in education although archetypes perhaps best illustrate the pitfalls of the general utilisation advice in practice because they are often used as a way to obtain results quickly. Because of the risks associated with the general utilisation advice (i.e., best practices), it is not recommended here.

The search for best practices in System dynamics as a support for a fixed recipe prevents the adaptive behaviour of the learning loop, which is so closely connected to the System dynamics approach that it no longer appears fruitful. Thus the quest for best practices should be changed to the quest for the best adaptive behaviours where the only best practice generally is the use of the learning loop. The adaptive learning behaviour creates a process where the purpose and problem statement are fine tuned to overlap successfully.

5.3.2 The risks associated to model packages

The problem associated with the general utilisation advice (GUA) brings the discussion to another interesting issue – ready-made model packages. There are many model packages in use that solve specific tasks. They are useful when the user has a specific reoccurring issue that needs investigation. If the issues are reoccurring, the questions may remain the same for different problems. For example, posing questions on ground hydrology for site A can be identical for site B since the problem is nearly identical between the sites. Therefore, model packages frequently use built-in questions to address the issue and provide results. The user acquires the input data that are required for the model package to create the result based on the model package requirements. This approach has obvious advantages since the user is not required to build a new model every time a new problem surfaces. Moreover, someone else has already constructed the model, saving both time and money for the user. However, there is a certain risk involved with model packages. If a model package is used to answer questions that reside outside the model package's intended focus, it may produce answers that are useless, an outcome possibly undetected by the user (Figures 5.26 and 5.27).

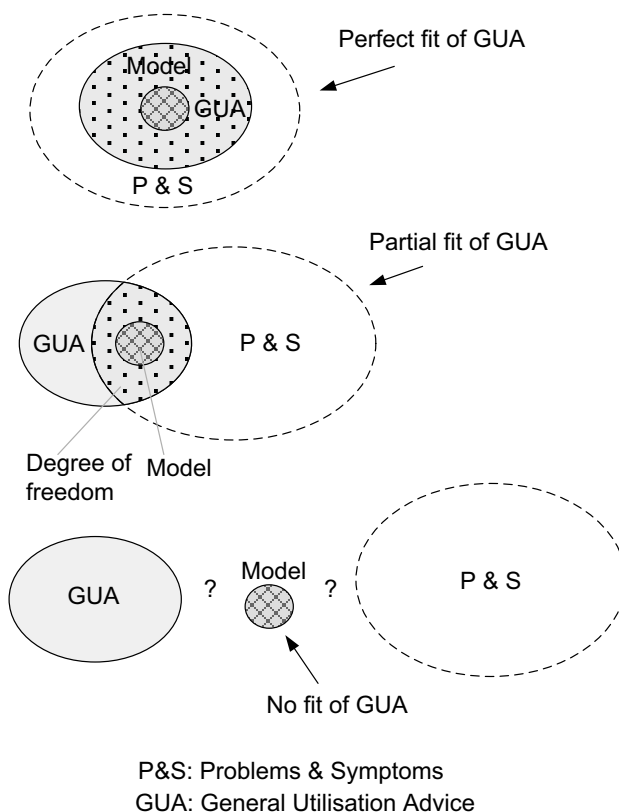

Figure 5.26. General utilisation advice (GUA) aims to accelerate and simplify the modelling process by offering shortcuts in the analysis of the problem and symptoms (problem statement). A model developed through the GUA approach can develop into 1) perfectly fitting the problem statement, 2) only partially fitting the problem statement, or 3) having no fit whatsoever. Without the proper knowledge of the underlying behaviour, there is no way the user can identify which one of the three 'fittings' applies to the model and therefore cannot assess if the questions adequately address the problem.

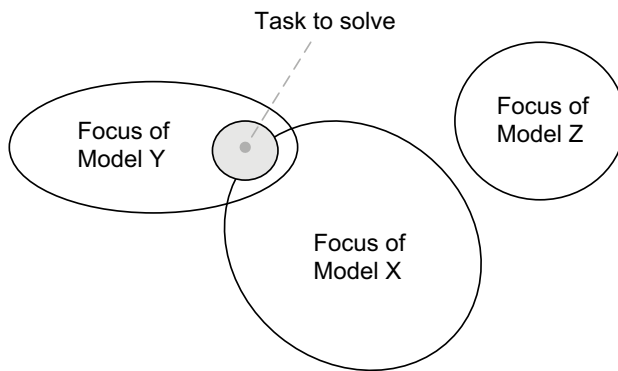

Figure 5.27. A model package focuses on solving a specific task. In this case, the user is presented with a choice of three model packages (X, Y, and Z) to solve a certain task. The task to solve fits within the focus of model package Y, but only partially for the focus of model package X and not at all within the focus of model package Z. Selecting the correct model package for the task requires the user to understand the principles of each of the model packages.

The user needs to know the assumptions and limitations of the model package to successfully use the tool. As previously discussed, models that lack explanation of their basic principles cannot be scrutinised and therefore have limited usefulness.

Although model packages are clear and transparent to the model builder, this will not always be the case for the intended user. Therefore, the model packages are equipped with large manuals that explain their content and how to prepare and manage data input. The user manual explains to the user the model utilization process – i.e., the support modules and the tools needed to successfully produce results and identify limitations. A model without a user manual becomes a black-box model since the explanation of the data preparation, the tools, and the methods used for inputs are not available. There is no free lunch when using a ready-made model package rather than developing and constructing a model. Both require understanding of the basic principles and purposes, the latter through the innovation phases and the former through the user manual. Using black box models captures the user in the model constructor. If the model user is comfortable with that and all of its potential ramifications, then everything is fine. If not, the user must prepare for the consequences. The fact that many model users have this blind trust can have significant consequences as a mistake made by many is actually worse than a mistake made by one.

Appendix 1: Diagnostic quizzes

Quiz # 1

Using CLDs

1.
 - a How many loops are there in the CLD below?
 - b On the CLD, identify reinforcing and balancing loops.

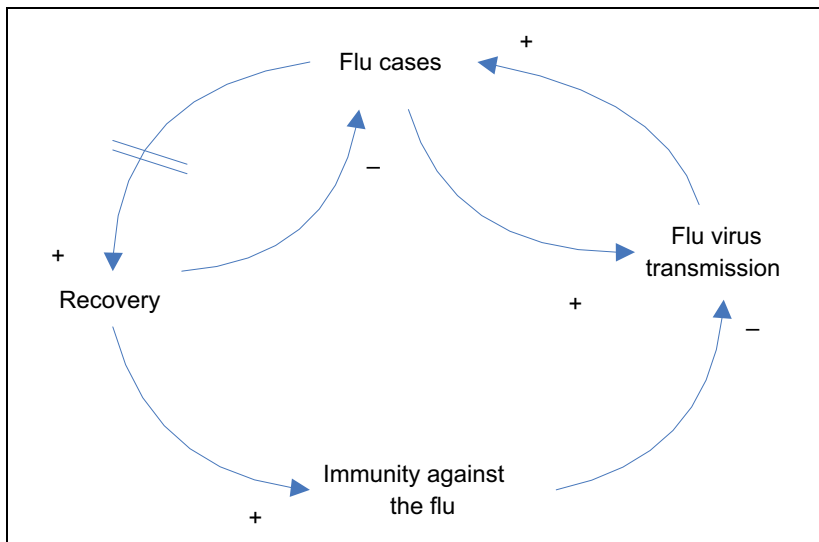

Figure 1. The flu.

- c In the space below, draw a RBP for the variable flu cases. Start with an increase in flu cases.

2. The basic economic principles are listed below:

- a Higher demand leads to a higher price.
- b Higher supply leads to a lower price.
- c Lower price leads to a higher demand.
- d Higher price leads to a higher supply.

Express the four statements above in a CLD, one CLD for each statement.

If the demand for a product increases, what would happen to the offer?

Use a RBP to illustrate your answer.

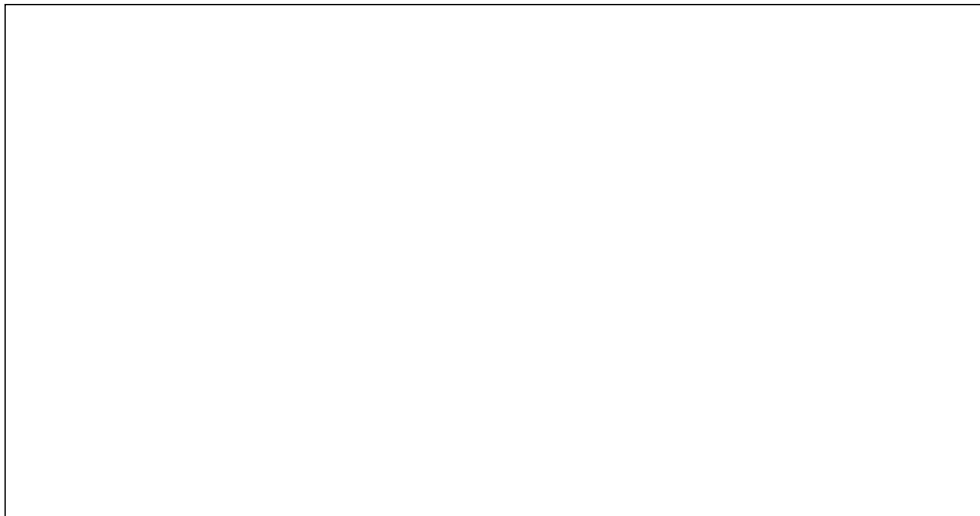

3. A mountain slope is an interesting ecosystem. The ecosystem usually has a vegetation line, which is explained differently in different cases. In Figure 2, the vegetation line is created by the steepness of the mountain side and by the rainfall. The establishment of the first vegetation colonies is accompanied by the establishment of a soil layer. Once soil is present, more vegetation can grow. The growth of the vegetation depends on rainfall. However, rain is not always a blessing. On the steeper slopes of the mountain, the erosion caused by rain is very strong and prevents the establishment of soil and therefore vegetation.

In the space below, draw a simple CLD explaining the vegetation line on a mountain slope.

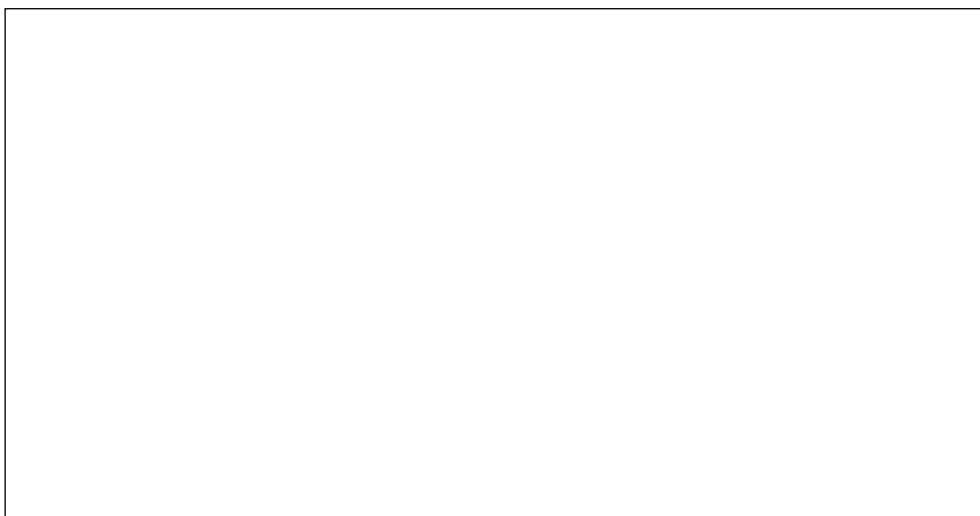

Quiz # 2

From CLD to SFD

- 1 On the CLD below, identify stocks, flows, and controls when present.

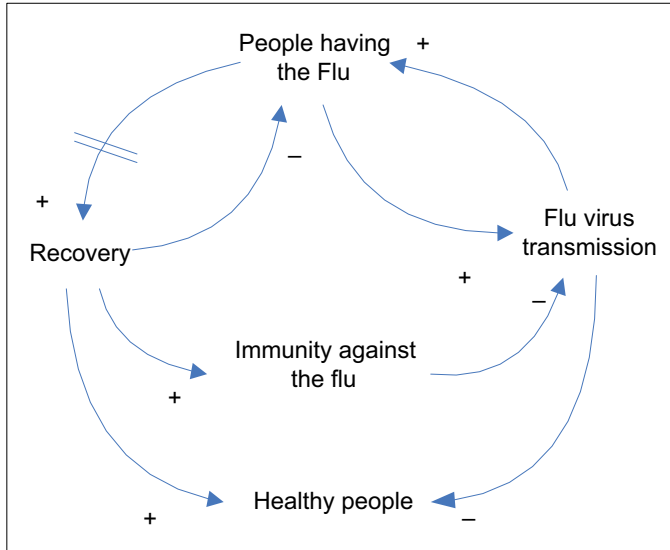

Draw a STELLA model that would correspond to the CLD you created.

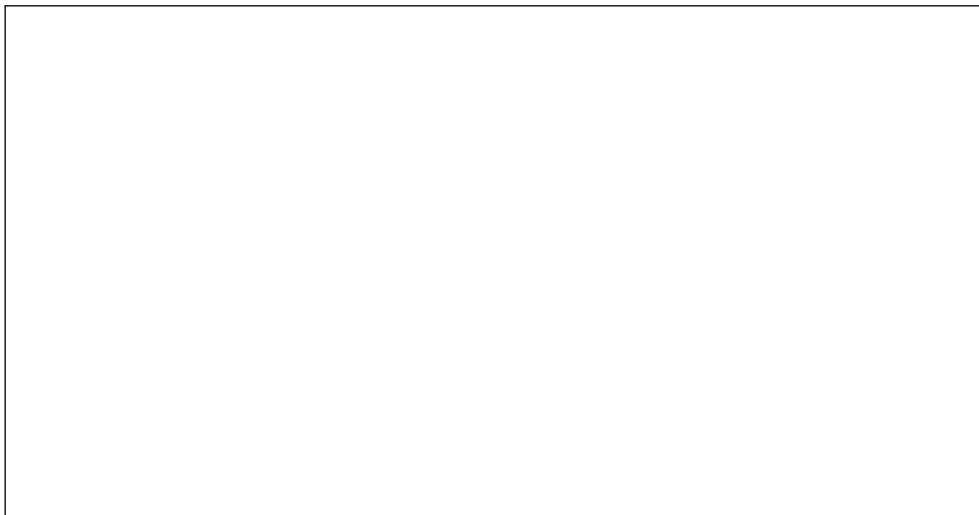

2 Based on the STELLA model and the dual relationships below, draw a CLD that corresponds to the modelled system.

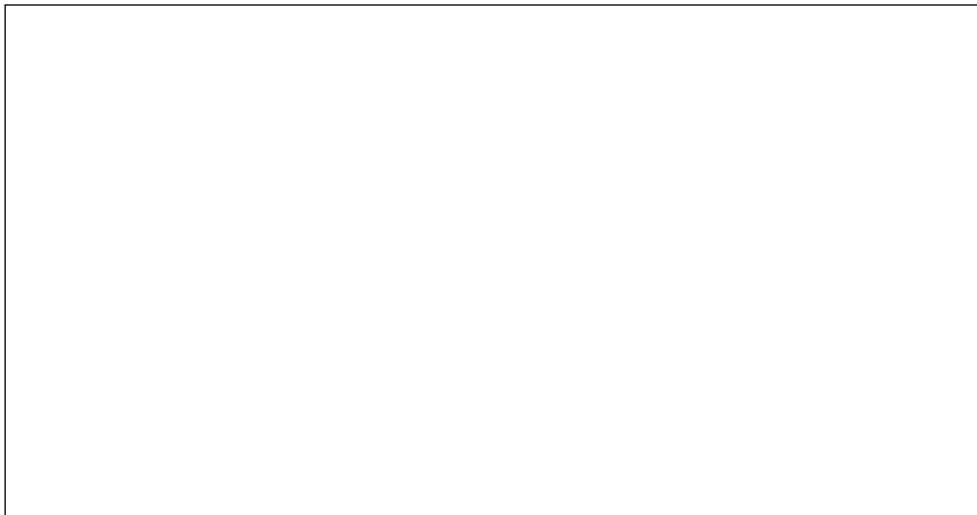
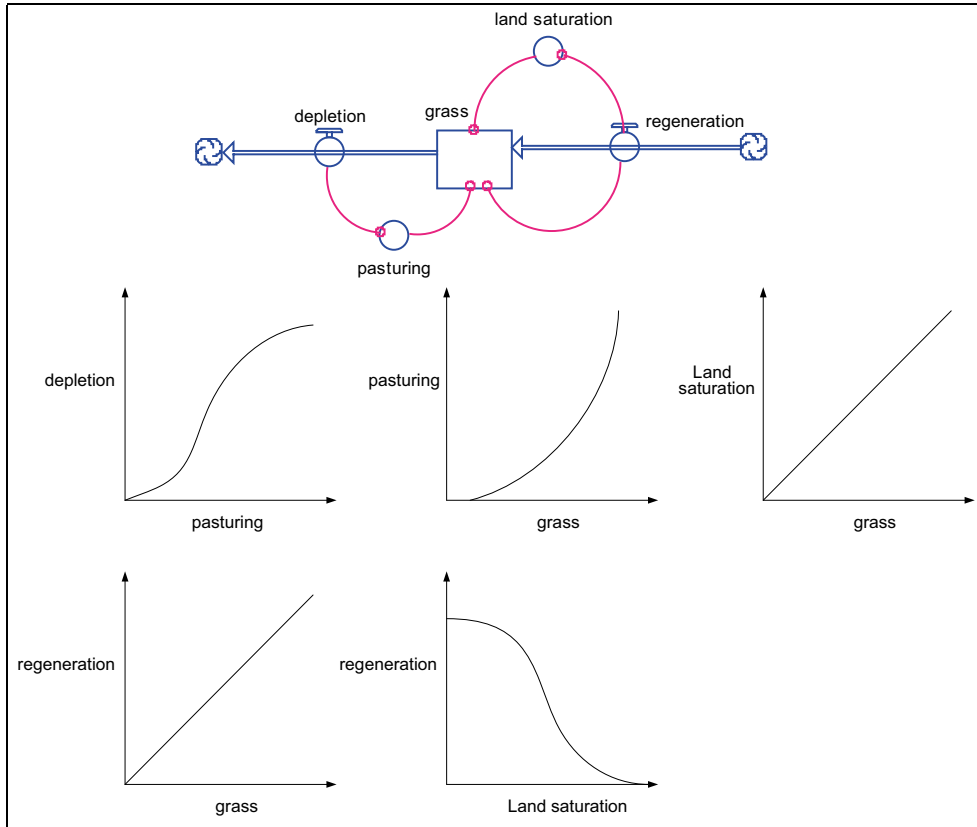

Quiz # 3

Make the connection and illustrate causalities



In an isolated forest, a majestic species of oak depends entirely on a small endemic squirrel for regeneration. The squirrels survive only on the acorns produced by the oaks. In the autumn, the acorns fall to the ground. However, they cannot germinate unless buried in the soil. If the acorn yield is too low, the squirrels reproduction will decrease and many of the weaker squirrels will die. The squirrels feed on some of the acorns produced in the autumn and bury some for later in the year. The buried acorns are the squirrels' food for the rest of the year. However, the buried acorns that are not eaten by the squirrels germinate after a year and some of these seedlings will become oak trees.

- 1 In the space below, make a simple CLD showing the interaction between the oaks and the squirrels.

2 In the space below, draw a STELLA model that corresponds to the CLD.

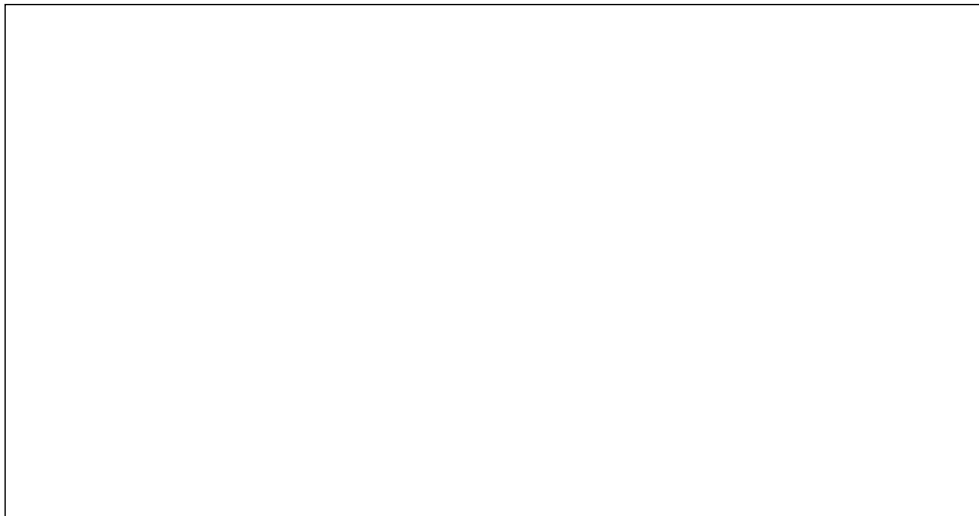

Quiz # 4

From Narrative to analysis – Fuelling the future, charcoal in Chad

News reporting is often done through narratives that are more often laid out in series and with supporting graphics and photographs. A news story conveys a mental image for the reader to formulate an idea or an opinion on the issue and raises questions. More often, the news narratives describe events and seldom delve into the analysis that was the root to the problem or the hidden structure that caused the situation. The following news story appeared in BBC News in 2005 as part of the BBC series *Fuelling the future*. The story describes the environmental problem stemming from the use of charcoal in Chad. The use of charcoal as fuel has a range of environmental problem as well as associated health issues. Although a regional issue, it illustrates how a problem can have a cascading effect on the environment and the society.

Analyse and frame the problem by connecting the events. List questions that directly relate to the current problem and the purpose of the analysis: What is the problem that needs a solution? What is the long-term goal and desired state? How is success defined? Look for the causalities that are not discussed but are hidden in the story. What are the underlying driving forces creating the problem? How does the problem manifest as undesired feedback loops? What can we do to break the vicious cycles, directly or indirectly? The idea is to create transparency where intervention is desirable and where possible win-win strategies exist.

Source BBC News 2005. Photos and text: Stephanie Hancock: http://news.bbc.co.uk/2/shared/spl/hi/picture_gallery/06/africa_charcoal_in_chad/html/1.stm



Modern fuel

As part of the BBC series *Fuelling the Future*, we look at the environmental problems in Chad, stemming from the widespread use of charcoal. Charcoal is the most popular type of fuel in Chad and is seen as more modern than firewood. It burns for longer than wood, so it is cheaper to use, and it produces less smoke. It is especially popular in big towns. Unfortunately, charcoal is less efficient, so more trees must be cut down.



Symbolic guns

Issa is chief warden in Gassi Forest, just south of the capital, Ndjamen. He heads a mobile patrol unit to stop people felling trees to make charcoal. Although chopping down green wood (i.e., living trees) is illegal, up to 200 trees are cut down each night: 'The tree-cutters are armed with knives and machetes. We have guns but they don't work and we are not allowed to use them, so what is the point?'



Disappearing forests

Despite its reputation as a dry and dusty country, southern Chad has many forests. But over the years, these have been systematically chopped down by people seeking firewood and now charcoal, both illegal activities. To find the people who supply the cities with this fuel, you have to search deep inside the bush.



'No choice'

Dede Mahamat, a charcoal producer, says he is forced into making charcoal to feed his family: 'I know what I'm doing is bad for the environment, but I have no choice. My family has nothing. With the money I make, I can at least buy some sugar for my four young children'. Dede says making charcoal is far more profitable than selling his sheep's milk and without the income from charcoal he cannot afford to send his children to school.



Elephants

After gathering the wood, Dede covers the logs with sand and sets fire to them. In four or five days, he will have enough for seven or eight sacks of charcoal. Dede says this area used to be covered with lush forest, where elephants would roam. But now the area has been destroyed and the elephants are gone.



'Intellectual'

Tingwa, a 30-year-old man, makes charcoal because he cannot find work in his village. He says he only makes charcoal once a month or so, because the work is very difficult: 'I'm an intellectual but am forced to do this to feed my three children. My children eat, my wife eats, I eat. I have to find money somewhere'.



Team effort

After collecting the wood, Tingwa has to burn it. He must rake all the charcoal together, and then it is put into sacks. He has enough in this batch for eight sacks, which he will sell for \$5 each. He works in a team, who then transport the charcoal by donkey to his village.



Baking bricks

Charcoal has many uses in Chad. It is used in the home for cooking, and hot coals are also loaded into irons in households without electricity. But it is also used on an industrial scale. These men are stoking the fire of a giant oven with charcoal. They are using the heat to bake mud bricks. After four days, the bricks will be baked and ready for sale.



Family tradition

Once the charcoal arrives in the cities, it must be delivered quickly to customers. Mahamat is 50 years old and selling charcoal is a family tradition. He starts work at dawn each day and is finished by mid-morning: 'I like my work except for the problem I have with forest controllers. Because there is no official tax rate, they just make the price up. They used to charge 20 US cents per sack to bring charcoal out of the forest but now they want 60'.



Good living

Mahamat's wife and children are busy making tea before he sets off for work selling charcoal. Mahamat says he earns a good living; he can send all ten of his children to school. He simply does not think about the environmental consequences of his work: 'As you can see, we even use charcoal at home ourselves. So who am I to tell people what they should or shouldn't do'.

Appendix 2: Glossary of terms

The following glossary was compiled by David N. Ford and gives an overview of generic terms and explanations used within the field of system thinking and systems dynamics. Many of the terms discussed in this publication are found below. The glossary is reproduced under the Creative Commons Attribute License with citation given: Ford, D. N. (2019). A system dynamics glossary. *System Dynamics Review*, 35(4), 369-379.

accumulation (integration): a gradual, non-instantaneous increase or decrease of a quantity over time. An accumulator is also referred to as a stock or level and represents the state of a system. To accumulate is the act of increasing and decreasing the size of a state variable (a stock) over time.

aggregation: the grouping of numerous distinct system components into one variable. Aggregation is done for simplicity when the grouping generates the same behavior of interest as those generated by the components separately.

aggregation level: the extent to which the system components are aggregated or disaggregated.

amplification: an increase in the magnitude of movements from an average value of a dynamic behavior, typically as in oscillations. Often implies a system response that is greater than is seemingly implied by input variables. Amplification can occur in information feedback systems when policies try to adjust levels to desired values in complex settings. It is associated with delays, order/inventory processes and forecasting.

archetype: see system archetype.

asymptotic growth/decay: goal-seeking behavior produced by negative feedback. The control stock moves towards the goal, slowing down as it approaches the goal.

auxiliary (convertor) variable: an intermediate, conventional variable to facilitate the expression of functional dependency of a flow to system stocks. A convertor is capable of changing its value instantaneously.

balancing feedback loop: a feedback loop in which the resultant effect of the causal links over time limits or constrains the movement of variables. Balancing loops seek equilibrium, trying to bring stocks to a desired state and keep them there. Also called a negative, compensating, goal-seeking or controlling feedback loop.

behavior mode: a shape or pattern over time of the values of a system variable. Behavior modes are typically displayed graphically using behavior-over-time graphs (BOTG), where time is represented on the x-axis and values of the variables are represented on the y-axis.

boundary (system boundary): a border enclosing the parts of system structure needed to generate the behavior of interest. The system boundary excludes all components not relevant to the problem behavior of concern.

bounded rationality: the theory developed by Herbert Simon that human decision making is rational only insofar as the rational solution does not require calculations or mental efforts that exceed cognitive limitations and available information. Bounded rationality is a characteristic of human decision making that often impacts system performance.

calibration: the process of setting model parameter values to reflect an actual case (or specific hypothetical conditions of interest).

causal: a driving or influencing relationship between two variables; in contrast to correlations, when two variables change together in time and/or space, but one does not necessarily drive or influence the other.

causal link: an arrow in a causal loop diagram or system structure diagram that describes a relationship between two variables with the direction of causality (from cause variable to impacted variable) and the nature of impact (same direction of change or opposite direction of change). If there is a significant delay in the influence of the driving variable on the driven variable, it can be represented by a link “broken” by parallel lines.

causal link polarity: a positive (+) or negative (-) sign that indicates the direction of impact of the driving variable on the driven variable. Positive polarity indicates that the impacted variable moves in the same direction (increase or decrease) as the driving variable. Negative polarity indicates that the impacted variable moves in the opposite direction (increase or decrease) to the driving variable. Alternatively, positive link polarity is sometimes indicated by the letter “S” (causing to move in the same direction) and negative link polarity by the letter “O” (causing to move in the opposite direction).

causal loop diagram: a tool that represents closed loops of cause–effect linkages (causal links) as a diagram intended to capture how the system variables interrelate and how external variables impact them. Causal loop diagrams identify and label feedback loops to facilitate understanding, dynamic reasoning and formal modeling.

closed-loop thinking: approaching a problem with an endogenous perspective, focusing on the role of feedback loops.

closed system: a system that functions without the influence of exogenous variables. The system internally generates the values of the variables through time by their interactions. A completely closed system does not exist in reality, but many systems do primarily determine their behaviors internally.

cloud: a symbol in a structure diagram that represents an infinite source or sink. An origin or ending place of a flow that is outside the boundary of the system as modeled. A cloud represents an unrepresented input or output stock of the system that is inconsequential to the behavior of interest.

co-flow: a parallel stock-and-flow structure that mimics a primary stock-and-flow structure in which the co-flow structure models an attribute or characteristic of the contents of the primary structure.

compensating feedback: a negative feedback structure typically used to denote one or more negative feedback loops that undercut the intended effects of a policy. See policy resistance.

computation interval: see solution interval. **connector:** the directed links in a model that carry information or influence from one element to another element. The information may take the form of an algebraic relationship or a graphical relationship. The connectors can directly influence/determine auxiliary variables or flows (rates), but never stocks.

conserved flow: a flow that moves a quantity of material between two or more stocks so that the total amount of material in the related part of the system is unchanged. The total amount of material is divided among the stocks. In contrast, non-conserved flows flow across the model boundary from or to a source or sink, where the quantity is “created” or “lost” (nonconserved). **controlling feedback loop:** see balancing feedback loop.

conveyor: a type of stock that represents a space into which material flows and stays for a fixed period of time, then exits. Its parameter determines transit time – how long material stays in the conveyor. Material that flows in at a given time is not mixed with material that flowed in earlier—a quantity that enters at t will flow out exactly at $t +$ transit time. Also called a pipeline delay.

counterintuitive behavior: when policies assuming a particular solution yield unexpected, surprising or paradoxical results that are very different from those intended or expected. Often, as troubles increase, well intentioned but flawed efforts are intensified, which reduce improvement or worsen the problem instead of improving the situation. See also policy

cyclical behavior: see oscillation.

dampening: a decrease in the magnitude of movements from an average value, typically in oscillations. Also a system response that is less than is seemingly implied by input variables.

decision function: a policy statement that determines how information is used to generate actions for managing the system. Also the algorithm used to transform incoming information into a stream of decisions over time.

delay: a phenomenon in which the effect of one variable on another does not occur immediately. A process by which the output lags behind its input in time.

delta time: see solution interval.

diffusion structure/behavior: a structure/behavior that describes the spread of products, ideas or beliefs, typically based on a model of new product adoption developed by Frank Bass.

dimensional analysis: a procedure that checks for unit consistency in equations.

disaggregation: the opposite of aggregation. Disaggregation is done to separate variables into components that do not have close enough effects on system behavior to be modeled with a single variable.

doubling time: the length of time it takes a quantity to double in size. Normally associated with exponential growth.

dynamic: changing over time. The opposite of static.

dynamic hypothesis: a structure that the modeler advances to explain a dynamic behavior of interest.

endogenous variable/view: internal, the opposite of exogenous. An endogenous view approaches a problem searching for its causes and solutions within the system boundary. Endogenous variables are affected by other system variables.

equilibrium: conditions in a dynamic system where the inflows and outflows of each stock balance each other, and the sizes of the stocks do not change.

equilibrium behavior: a behavior mode in which all stocks are at equilibrium conditions. Static equilibrium behavior occurs if all flows are zero (so the contents of stocks do not change over time). Dynamic equilibrium behavior occurs if flows are non-zero but they balance (so the contents of stocks change, but their values stay constant) over time. Asymptotic equilibrium behavior means the system approaches equilibrium values, but does not reach these values in finite time.

equilibrium conditions: a system structure and set of numeric conditions that generate equilibrium behavior.

exogenous variable/view: external, the opposite of endogenous. An exogenous view assumes that a system's behavior is dominated by the influence of outside forces or factors. An exogenous variable is an external (input) variable that affects but is not affected by the system.

exponential behavior: a nonlinear behavior mode generated by a relationship in which the change in a stock variable is proportional to the size of the variable itself.

exponential decay: a behavior mode that occurs when the rate of increase or decrease in a variable (usually a stock) is proportional to how far the stock is from its equilibrium, so as to slow down its rate of change. As the stock gets larger (smaller), its increase (decrease) occurs progressively more slowly. The speed of increase or decrease can be described by half-life. The corresponding structure is associated with negative feedback and tends to generate goal-seeking behavior.

exponential delay: a model structure in which a value moves towards the input or target value gradually, in a goal-seeking exponential fashion.

exponential growth (or collapse): a behavior mode that occurs when the rate of increase or decrease in a stock variable is proportional to the size of the stock at that point in time, so as to accelerate its change. As the stock gets larger (smaller), its increase (decrease) occurs progressively more quickly. The speed of increase or decrease can be described by doubling time. The corresponding structure is associated with positive feedback.

feedback: when the effect of a causal impact comes back to influence the original cause of that effect. A feedback loop is a sequence of variables and causal links that creates a closed ring of causal influences. See reinforcing feedback loop and balancing feedback loop.

feedback loop polarity: a characteristic of feedback loops represented by a positive (+) or negative (–) sign that indicates whether a loop is a reinforcing (positive) or balancing (negative) one. Loop polarity is found by the algebraic product of all signs around a loop.

flow (rate): the movement of quantities between stocks within a system boundary or across the model boundary and thereby into or out of the system (sinks and sources); changes in stocks over time. Flows represent activity, in contrast to stocks, which represent the state of the system.

formalization (specification): the creation of a model from a conceptual model that can be mathematically analyzed, solved or simulated.

frequency of oscillation: a descriptive measure of oscillatory behavior. The number of cycles a system generates in a time unit. The inverse of the period of oscillation.

generic structure: a structure that can be applied across different settings due to having the same fundamental underlying components and relationships. See system archetype.

goal-seeking behavior: a behavior mode in which the system moves towards an equilibrium or target condition. The flow that changes the stock value is typically modeled as a fraction of the difference between the equilibrium condition (or target) and the current condition. Therefore, the further the system is from the goal, the more it changes towards that goal and as it approaches the goal the increase or decrease slows. The corresponding structure is associated with negative feedback. See exponential behavior.

graphical differentiation: the process of using graphs to determine and describe the net flows that impact a stock, based on the given values of the stock over time; the complement of graphical integration.

graphical function: a graph that relates the values of one variable to the values of another. The relation between input and output variables is plotted on a graph. Often used to describe nonlinear relationships.

graphical integration: the process of using graphs to determine and describe how a stock changes over time, based on the behavior of its flows.

group model building: a methodology for building models in which a group or team of people participate actively and simultaneously in building the model.

growth with overshoot: a behavior mode in which a system increases beyond its target or equilibrium condition and then decreases. See overshoot and collapse.

half-life: the time required for a stock to move halfway towards its goal. Associated with goal-seeking behavior. The half-life is the converse of doubling time in positive feedback.

high-leverage point (high-leverage parameter): part of a system where small changes can have a very large impact on system behavior and is therefore effective for focusing system design, management attention and resources.

homeostasis: the tendency of organisms to preserve their equilibrium conditions. Control through the operation of negative feedback loops – homeostasis is reached when the goal is attained and stable equilibrium achieved.

impulse: theoretically, a signal of zero duration but non-zero finite height and area. Practically, in simulation models, a signal (flow) of specified area lasting for one solution interval and occurring at a specified time.

information delay: a delay that represents the gradual adjustment of information, perceptions or beliefs, or a gradually delayed impact of some variable on a flow or auxiliary variable. Used to model non-conserved variables.

integration: see accumulation.

integration error: error generated in computer simulations due to the mathematical method used to approximately compute variable values.

limits to growth: a resource constraint, an external or internal limiting response to growth. An initial growth begins to slow and eventually comes to a halt at the limit, and may even reverse itself and collapse.

linear system: a system in which all relations between variables are mathematically linear. In such systems, the complete behavior can be found by superimposing different behavior modes without interacting with one another.

link polarity: see causal link polarity.

Little's law: the relationship among the size of a stock, the net flow into or out of the stock, and the average time material stays in the stock under conditions of perfect mixing and when the system is in equilibrium. At equilibrium, the size of the stock is the product of the net flow and the delay.

look-up function: see table function.

loop dominance: a characteristic of feedback systems in which a loop is strong enough to determine the behavior mode of a part of the system. In a system with multiple loops, the mathematical relations, magnitudes and algebraic signs of variables determine what kind of behavior is dominant in any time period.

loop polarity: see feedback loop polarity.

material delay: a continuous delay that captures the time delay in the flow of conserved material through a process.

mental model: a relatively enduring and accessible, but limited, internal conceptual representation of a system (historical, existing, or projected) whose structure is analogous to the perceived structure of that system. Mental models represent the relationships and assumptions about a system held in a person's mind.

model boundary: see boundary.

model credibility (validity): how well a model represents a given problem; a model's suitability for a particular purpose. A model is credible/valid if it can accomplish what is expected of it, as demonstrated by structure and behavior tests.

model justification (validation): the process of developing confidence in a model's credibility and usefulness, performed with tests of model structure similarity to actual structures, simulated behaviors that reflect the behaviors of the system modeled, and ultimately impacts of the model suggestions on actual systems and problems.

negative feedback: feedback that works against deviations from a goal. In isolation or if dominant, negative feedback generates goal-seeking behavior.

nonlinear relationship: a causal relationship between two variables in which the change in the impacted variable is not directly proportional to the change in the impacting variable.

open-loop thinking: approaching a problem with an exogenous perspective, without applying the importance of feedback (endogenous structure).

oscillation: behavior exhibited by a second-order or a higher-order system in which the stock value increases and decreases cyclically over time. Three types of oscillation are: sustained, where the amplitude stays constant; expanding, where the amplitude increases; and dampened, where the amplitude decreases.

overshoot and collapse: a behavior mode in which a system variable increases beyond the equilibrium condition, often destroying its ability to sustain itself, and then collapses to lower equilibrium conditions. See growth with overshoot.

parameters: constant factors in relationships in a model.

period of oscillation: the time duration in which the oscillatory behavior repeats itself. The inverse of the frequency of oscillation.

phase plot: a plot of the behavior of one endogenous variable in relation to another endogenous variable.

pipeline delay: a fixed or discrete-time delay. See conveyor.

polarity: see causal link polarity or feedback loop polarity.

policy: a decision rule or structure that uses information streams to generate decisions.

policy analysis: analysis employed to evaluate policies to alleviate undesirable behaviors of a system. It allows the model builder to compare how a system would react to different policies through simulation.

policy resistance: circumstances in which policies are delayed, diluted or defeated by the unforeseen reactions of various factors and (usually negative) feedbacks in the system.

positive feedback: a structure that produces exponential growth or collapse. Change in one direction results in more and faster change in the same direction.

positive feedback loop: see reinforcing feedback loop.

pulse function: see impulse.

ramp function: a common input variable that changes linearly over time.

rate: see flow.

reference mode: a behavior-over-time graph that depicts how one or more system variables change over time, often used in problem articulation to describe the dynamic hypothesis, and in model validation to test a model's ability to reproduce realistic behavior patterns.

reinforcing feedback loop: a feedback loop in which the sum effect of the causal links tends to strengthen (reinforce) the movement of variable values in a given direction due to positive feedback.

sensitivity analysis: analysis used to determine how responsive model outputs are to changes in specific parameters, or policies or structures. Behavior that changes drastically suggests a critically important factor or high sensitivity. Conversely, if a large change in a parameter value or a structure results in small changes in behavior, that factor is not likely to be central to the dynamics in question; that is, the behavior shows low sensitivity.

simulation: the generation of the behavior of a system with a formal computer model.

sink: see cloud.

smoothing: filtering out short-term noise-like fluctuations in a time series to detect or reveal underlying, significant patterns.

solution interval (computation interval, delta time (dt), time step): the interval of time between successive computer calculations used to simulate behavior in a formal model.

source: see cloud.

S-shaped growth: growth that exhibits a behavior like a flat “S” shape. Values initially grow exponentially, then slow down and approach a maximum value. Endogenously caused S-shaped growth is typically generated by a shift in loop dominance from a positive feedback structure to a negative feedback structure.

stability (stable behavior): behavior in which the system moves toward equilibrium conditions after being disturbed or remains within specified limits. In an unstable system or region a disturbance is amplified, leading to increased growth, collapse or oscillation away from equilibrium.

stable equilibrium: a system structure and set of parameter values in which, if the system is moved away from the equilibrium conditions, the system tends to return to those conditions. See also unstable equilibrium.

stasis: see equilibrium behavior.

state variable: see stock.

static: not changing over time; constant. The opposite of dynamic.

steady-state behavior: a behavior pattern that is repetitive or constant over time and in which the behavior in one time period is of the same nature as any other period.

step function (step input): an input (usually for testing purposes) that suddenly changes by a fixed amount and then remains at the new value.

stock (level): an accumulation of quantities in specific locations or conditions in a system. A component of a system that accumulates or drains over time. Stocks are the memory of a system and can only be changed by flows.

stock-and-flow diagram: a visual depiction of the stock, flow and auxiliary (converter) variables in a system and how they are connected. **structure diagram:** A diagram that displays the system feedback and accumulation structure.

structure: see system structure.

system: a collection of parts that interact in a meaningful, inseparable way to function as a whole.

system archetype: an integrated feedback structure, the resulting behavior mode or modes, and a story of how the structure can create the behavior modes, so as to describe a common problem and potential solutions. A type of generic structure.

system boundary: see boundary.

system structure: the way in which system elements are organized or inter-related. The totality of feedback loops, stocks, flows and time delays in the system. The building blocks and connections of a system.

systems thinking: the use of conceptual system models and other tools to improve the understanding of how the feedback, delays and decisionmaking policies in a system's structure generate the system's behavior over time. Systems thinking does not use computer simulation. Systems thinking involves (i) seeing interrelationships and feedback loops instead of linear cause-effect chains, and (ii) seeking processes of change over time rather than events/snapshots. Systems thinking helps people see things on three levels: events, patterns of behavior and system structure.

table function: a numeric table version of a graphical function.

time step: see solution interval.

transferable structure: see generic structure.

transient behavior: a dynamic response that does not persist. Temporary, short-term behavior, typically between equilibrium conditions.

unintended consequence: an unplanned and typically undesirable side effect of well-meaning intentions and actions, often occurring after a time delay and across an organizational boundary from the intended action.

unstable behavior: behavior over time that does not converge to an equilibrium or remain within specified limits.

unstable equilibrium: a system structure and set of parameter values in which, if the system is moved away from the equilibrium condition, the system tends to move further away from it. Also see stable equilibrium.

vicious cycle: a reinforcing loop or amplifying structure that yields undesirable results.

virtuous cycle: a reinforcing loop or amplifying structure that yields desirable results.

References

- Agenda 21 i Sverige. Fem år efter Rio-Resultat och framtid. Sveriges Offentliga Utredningar, SOU 1997:105
- Ainsworth C. and Sumaila, U. 2003. Intergenerational discounting and the conservation of fisheries resources: A case study in Canadian Atlantic cod. In Ed. U. Sumaila: Three essays on the economics of fishing. Fisheries Centre Research Reports 11:26-33, Vancouver, Canada.
- Albin, S., 1997 Building a system dynamics model; Part 1; Conceptualization. MIT System Dynamics Education Project (J. Forrester (Ed)). MIT, Boston. 34pp. <https://ocw.mit.edu/courses/sloan-school-of-management/15-988-system-dynamics-self-study-fall-1998-spring-1999/readings/building.pdf>
- Ammerman and Cavalli-Sforza 1972. The Neolithic transition and the genetics of populations in Europe. Princeton University Press, Princeton, New Jersey.
- Arnarson, M., Kristjánsson, Þ., Bjarnason, A., Sverdrup, H., Ragnarsdóttir K.V., 2011. The Icelandic Economic Collapse, A Systems Analysis Perspective on financial, social and world system links, © 2011, University of Iceland, Reykjavik, Iceland 74pp. <http://hdl.handle.net/1946/9908>
- Azar, C., Holmberg, J. and Lindgren, K. 1996. Socio-ecological indicators for sustainability. Ecological economics 18, 89-112.
- Bahn, P. 1992 Easter island, earth island.
- Beder, S. 2000. Costing the earth: Equity, sustainable development and environmental economics. New Zealand Journal of Environmental Law 4: 227-243
- Belyazid, S., 2006. Dynamic modelling of biogeochemical processes in forest ecosystems. PhD Thesis, Lund University, Lund, 250 pp.
- Binder, T., Vox, A., Belyazid, S., Haraldsson, H.V. and Svensson, M., 2004. Developing System Dynamic Models from Causal Loop Diagrams, 22nd International Conference of the System Dynamic Society. System Dynamic Society, Oxford.
- Bossel, H. 1998. Earth at the crossroads. Paths to a sustainable future. Cambridge University Press,
- Burns, J.R., 2001. Simplified Translation of CLD's into SFD's, 19th International Conference of the System Dynamic Society. System Dynamic Society, Atlanta, USA.
- Cavalli-Sforza, L. L., Menozzi, P. and Piazza, A.: 1994, The history and geography of human genes, Princeton University Press, New Jersey.

- Checkland, P., 2000. *System Thinking, Systems Practice, Includes a 30-year retrospective*. Wiley, New York, 330 pp.
- Daily, G and Ehrlich, P. 1992. Population, sustainability and the earth's carrying capacity. A framework for estimating population sizes and lifestyles that could be sustained without undermining future generations. *J. Bioscience*.
- Diamond, J. 1998: *Guns, Germs and Steel*
- Diamond, J., 2002: *Collapse*
- Dolgopolski, A.: 1986, A probabilistic hypothesis concerning the oldest relationships among the language families in Northern Eurasia, in V. Shevoroshkin and T. Markey (eds), *Typology, Relationships and time*, Karoma, Ann Arbor.
- Drengson, A. and Taylor, D. (Eds.) 1997. *Ecoforestry*. New Society Press, Gabriola island
- Dryzek, J.S. and Schlossberg, D. (Eds.) 1998. *Debating the Earth. The environmental politics reader*. Oxford University Press, London.
- Eckersley, R. 1992. *Environmentalism and political theory: Toward and ecocentric approach*. SUNY, New York.
- van Egmond, N.D., and de Vries, B., 2015. Dynamics of a sustainable financial-economic system. Working Paper. Utrecht University. Sustainable Finance Lab. 52 pages.
- Ford, D.N., 1999. A behavioral approach to feedback loop dominance analysis. *System Dynamics Review*, 15(1): 3-36.
- Ford, D. N. (2019). A system dynamics glossary. *System Dynamics Review*, 35(4), 369-379.
- Forrester, J., 1958; *Industrial Dynamics- – A Major Breakthrough for Decision Makers*. *Harvard Business Review*, 36, 37–66.
- Forrester, J. W. 1961. *Industrial Dynamics*. Pegasus Communications. ISBN 1-883823-36-6.
- Forrester, J. W. 1968. *Principles of systems*. Pegasus Communications.
- Forrester, J.W., 1968. Market growth as influenced by capital investment. *Industrial Management Review*, 9: 83-105.
- Forrester, J. W. 1969. *Urban Dynamics*. Pegasus Communications. ISBN 1-883823-39-0.
- Forrester, J. 1971a *World dynamics*. Pegasus Communications, Waltham Massachusetts.

- Forrester, J. 1971b Counterintuitive behaviour of social systems. *Theory and Decision* 2:109-140. Based on testimony for the Subcommittee on Urban Growth of the Committee on Banking and Currency, U.S. House of Representatives, on October 7, 1970
- Forrester, J. 1971 *World dynamics*. Pegasus Communications, Waltham MA
- Gilman, R. 1990. Sustainability: The State Of The Movement. *In Context* 25, 10.
- Haraldsson, H.V., 2004. *Introduction to Systems Thinking and Causal Loop Diagrams*. Reports in Ecology and Environmental Engineering. Institute of Chemical Engineering, Lund, 49 pp. 5th Revised edition.
- Haraldsson, H.V., 2005. *Developing methods for modelling procedures in System Analysis and System Dynamics*. PhD Thesis, Lund University, Lund, 300 pp.
- Haraldsson, H.V. 2005 Simulating the pre-industrial carrying capacity of the Icelandic environment using a simple approach. *Science of the Total Environment*, 372:109-119
- Haraldsson, H.V. and Ólafsdóttir, R., 2003. Simulating the dynamics in vegetation cover with regards to long-term climatic variations in sub-arctic landscapes. *Global and Planetary Change*, 38: 313-325.
- Haraldsson, H.V. and Sverdrup, H.U., 2003. Finding Simplicity in complexity in biogeochemical modelling. In: J. Wainwright and M. Mulligan (Editors), *Environmental Modelling: Finding Simplicity in Complexity*. Wiley, New York, pp. 211-223.
- Haraldsson, H., 2005. *Developing Methods for Modelling Procedures in System Analysis and System Dynamics [PhD Thesis]*: Lund University, 300 p.
- Haraldsson H. and Sverdrup, H., 2005. On aspects of systems analysis and dynamics workflow. *Proceedings of the systems dynamics society*, July 17-21, 2005 International Conference on systems dynamics, Boston, United States of America. 1-10 pages. <http://www.systemdynamics.org/conferences/2005/proceed/papers/HARAL310.pdf>
- Haraldsson, H.V., Belyazid, S., Sverdrup, H. 2006 Causal Loop Diagrams, promoting deep learning of complex systems in engineering education. In: Alveteg, M. and Leire, E. (Eds.) *LTH pedagogiske inspirasjonskonferens 2006*: 1-4.
- Haraldsson, H., Sverdrup, H. Belyazid, S. Holmqvist, J. Gramstad, R.C.J. 2008 The tyranny of small steps: A reoccurring behaviour in management. *Systems Research and Behavioral Science* 25:25-43

- Haraldsson, H., Sverdrup, H., Belyazid, S., Sigurdsson, B., Halldorsson, G. 2007 Assessment of effects of afforestation on soil properties in Iceland, using systems analysis and system dynamics methods. *Icelandic Agricultural Science* 20:107-123
- Haraldsson, H.V., Sverdrup, H., Belyazid, S., Svensson, M.G., Kalén, C., Koca D., 2002 The Coming Water Shortage in the Jordan River Basin: Finding Objectivity in a Subjective Problem. The 20th International Conference of the System Dynamic Society, Palermo, Italy, July 2002. <http://www.systemsmodelbook.org/viewmodel.aspx?id=673eb716-3a8f-4126-bdc6-32c92b347699>
- Homer, J. and Oliva, R., 2001. Maps and models in system dynamics: a response to Coyle. *System Dynamics Review*, 17: 347-355.
- Hougen, O.A. and Watson, K.M., 1943, 1947. *Chemical Process Principles: Part I Material and Energy Balances*. Wiley, New York, 452 pp.
- Hougen, O.A. and Watson, K.M., Ragatz, R., 1948, 1954, 1959. *Chemical Process Principles Part II Thermodynamics*. Wiley, New York.
- Howells, W. W.: 1983, *Origins of the Chinese people: Interpretations of the recent evidence*, in D. N. Keightley (ed.), *The origins of Chinese civilization*, University of California Press, Berkley.
- Jopp, F., Jørgensen, S. E., Trexler, M., Reuter, H., DeAngelis, D., Breckling, B. 2011. *Modelling complex ecological dynamics: an introduction into ecological modelling for students, teachers & scientists*. Springer Science and Business Media.
- Kim, D.H., 1992. *Toolbox: Guidelines for Drawing Causal Loop Diagrams*, *The Systems Thinker*, 3; 5–6
- Lorenz, U., Sverdrup, H. U., Ragnarsdottir, K.V., 2017. Global megatrends and resource use - A systemic reflection. In: (Eds): Hinzmann, M., Evans, N., Kafyke, T., Bell, S., Hirschnitz-Garbers, Martina Eick (Series editor Lehmann, H.); *Factor X; Challenges, implementation strategies and examples for a sustainable use of natural resources*. Pages 31-44. Springer, ISBN 978-3-319-50078-2 ISBN 978-3-319-50079-9 (eBook) <https://doi.org/10.1007/978-3-319-50079-9>
- Luna-Reyes, L.F. and Andersen, D.L., 2003. Collecting and analyzing qualitative data for system dynamics: methods and models. *System Dynamics Review*, 19(4): 271-296.
- Maani, K.E. and Cavana, R.Y., 2000. *System Thinking and Modelling, Understanding Change and Complexity*. Prentice Hall, Auckland, 2nd Edition, 278 pp.
- Maani, K.E. and Cavana, R.Y., 2007. *System Thinking and Modelling, Managing Change and Complexity*. Prentice Hall, Auckland, 262 pp.

- MacIntosh, A. and G. Edwards-Jones, 2000. Discounting the children's future? *Geophilos* 1:122-133
- Malthus, T. R. 1798 An essay on the principle of population as it affects the future improvement of society, reprinted in Ed J. Newman: *The world of mathematics*, vol II:1192-1199 as "The mathematics of food and population". Simon and Schuster, New York 1956.
- Meadows, D.L., 1970 *Dynamics of Commodity Production Cycles*, 103pp, Wright-Allen Press, Cambridge, Mass.
- Meadows, D. H., D. L. Meadows, J. Randers, W. Behrens, 1972 *Limits to growth*. Universe Books, New York
- Meadows, D.L., Behrens III, W.W., Meadows, D.H., Nail, R.F., Randers, J., Zahn, E.K.O 1974. *Dynamics of Growth in a Finite World*. Wright-Allen Press, Cambridge, Massachusetts, 637 pp.
- Meadows, D.H, Meadows, D.L, Randers, J. 1992. *Beyond the limits: confronting global collapse, envisioning a sustainable future*. Chelsea Green Publishing Company
- Meadows, D.H, Randers, J., Meadows, D.L 2005 *Limits to Growth, the 30-year Update*. Earthscan, Sterling Virginia.
- Mesarovic, M. and Pestel, E. 1975 *Mankind at the turning point: the second report to the Club of Rome*. Research and Documentation Papers: Economic Series No. 1. EU European Parliament Document. <http://aei.pitt.edu/42190/>
- Mesarovic, M.D., Macko, D., Takahara, Y. 2000. *Theory of hierarchical multilevel systems*. Elsevier. Millennium Ecosystem Assessment 2005 *Ecosystems and Human Wellbeing (Millennium Ecosystem Assessment)*. Synthesis Report. Island Press.
- Mäki, U., 2012. *Models, Simulations, and the Reduction of Complexity*, ed. U. Gähde, S. Hartmann and J.H. Wolf. Berlin / New York: Walter de Gruyter 2012.
- Nei, M. and Roychoudhury, A. K.: 1982, Genetic relationship and evolution of human races, *Evolutionary Biology* 14, 1--59.
- Norgaard, R.B. and Horworth, B. 1991. Sustainability and discounting the future. In: Costanza, R. (Ed.) 1991. *Ecological economics: the science and management of sustainability*. Columbia University Press, New York.
- van Pelt, M.J.F., Kuyvenhoven, A. and Nijkamp, P. 1995. Environmental sustainability: issues of definition and measurement. *International Journal of Env. Poll.* 5, 204-223.
- Perman, R., Ma, Y. and McGilvray, J. 1996. *Natural Resource and Environmental Economics*. Addison Wesley Longman Ltd.

- Ponting, C. 1993. The green history of the world: The Environment and the Collapse of Great Civilizations. Penguin, New York.
- Peters, R. H. 1991. A critique for ecology. Cambridge University Press
- Ragnarsdóttir, K.V. and Sverdrup, H. 2014. Solutions for a Broken System: Toward a New Economic Paradigm. Putting Up The Sail: E F Schumacher's Economics and the Lessons of the Great Recession. Pages 12-17. Schumacher Briefings, Bristol, United Kingdom, Web-based E-book.
- Ragnarsdottir, K.V., Sverdrup, H.U., 2015. Limits to growth revisited. Kristín Vala Ragnarsdóttir and Harald U Sverdrup put natural resources into Global Perspective. Feature article, Geochemist October 2015. Front page and 10-15. <http://www.geolsoc.org.uk/Geoscientist/October-2015/Limits-to-growth-revisited>,
- Randers, J., 1980. Elements of the System Dynamic Method. Productivity Press, Cambridge, 320 pp.
- Randers, J. 2012. 2052, a global forecast for the next 40 years. A report to the Club of Rome. Chelsea Green Publishing, Vermont, USA
- Renfrew, C.: 1989a, Archaeology and language-The puzzle of Indo-European origins, Penguin Books, 27 Wrights Lane, London W8 5TZ, Great Britain.
- Renfrew, C.: 1989b, Models of change in language and archaeology, Transactions of the Philological Society 87:103—155
- Renfrew, C.: 1994a, Before Babel, Speculations on the origins of linguistic diversity, Cambridge Archaeological Journal 1:3--23.
- Richardson, G.P., 1986. Problems with causal loop diagrams. System Dynamics Review, 2(2): 158-170.
- Richardson, P.G. and Pugh III, A., 1981. Introduction to system dynamics modeling. Productivity Press, Portland, 413 pp.
- O'Riordan, T. 1988. The politics of sustainability, In Turner, R. (Ed.) Sustainable environmental management: Principles and practice. Belhaven, London.
- Roberts, N., Anderssen, D.F., Deal, R.M., Garet, M.S. and Shaffer, W.A., 1983. Introduction to Computer Simulation. Productivity Press, Portland, 562 pp.
- Ruehlen, M.: 1988, Guide to the worlds languages, Stanford University Press, Stanford.
- Ruehlen, M.: 1994, On the origin of language, Stanford University Press, Stanford.
- Sabloff, J. 1988. New archaeology and the maya. Scientific American Books. New York

- Schlyter, P., Stjernquist, I., Sverdrup, H. 2012a Handling Complex Environmental Issues – Formal Group Modelling as a Deliberative Platform at the Science-policy-democracy Interface. In The 30th International Conference of the Systems Dynamics Society. St. Gallen.
- Senge, P., 1990. The fifth discipline, The art and practice of the learning organisation. Century Business, New York, 424 pp.
- Senge P.M., Smith B., Schley S., Laur J., Kruschwitz N. 2008. The Necessary Revolution: How Individuals and Organisations Are Working Together to Create a Sustainable World. Doubleday Currency, London,
- Shevoroshkin, V. and Manaster Ramer, A.: 1991, Some recent work on the remote relations of languages, in S. Lamb and E. D. Mitchell (eds), Sprung from some common source, Stanford University Press, Stanford, California.
- Smith, B. D, 1995. The emergence of agriculture. Scientific American Library, New York.
- Sterman, J.D., 2000. Business Dynamics, System Thinking and Modeling for a Complex World. Irwin McGraw-Hill, New York, 982 pp.
- Stringer, C.: 1990, The emergence of modern humans, Scientific American 263, 68-74.
- Sverdrup, H.U. and Stjernquist, I., 2002. Developing principles for sustainable forestry. Kluwer Academic Publishers, 608 pp.
- Sverdrup H., and M. Svensson. 2002 Defining sustainability In: Developing principles for sustainable forestry, Results from a research program in southern Sweden. H. Sverdrup and I. Stjernquist (eds) Managing Forest Ecosystems 5: 21-32 Kluwer Academic Publishers, Amsterdam
- Sverdrup H., and M. Svensson; 2002. Defining the concept of sustainability, a matter of systems analysis. In: Eds.: M. Olsson and G. Sjöstedt; Revealing complex structures -- Challenges for Swedish systems analysis, 122-142. Kluwer Academic Publishers
- Sverdrup, B. Nihlgård, M. Svensson, G. Thelin; 2002, Principles of sustainable forest management. In: Developing principles for sustainable forestry, Results from a research program in southern Sweden. H. Sverdrup and I. Stjernquist (eds.) Managing Forest Ecosystems 5:33-56, Kluwer Academic Publishers, Amsterdam
- Sverdrup, H. 1999, Calculating language relationships and paths of dispersal in Eurasia during the last 100,000 years using the LANGUAGE model. In: V. Shevoroshkin and P. Sidwell, editors, Historical linguistics and lexicostatistics, Association for the history of language monographs and serials 3:169-200 Melbourne.

Sverdrup, H., and Olafsdottir, A.H, 2018. A system dynamics model assessment of the supply of niobium and tantalum using the WORLD6 model. *Biophysical Economics and Resource Quality* 4: 1-42

Sverdrup, H., Olofsdottir, A.H., Ragnarsdottir, K.V., Koca, D., 2018. A system dynamics assessment of the supply of molybdenum and rhenium used for superalloys and specialty steels, using the WORLD6 model. *Biophysical Economics and Resource Quality* 4: 1-52

Sverdrup, H., Ragnarsdottir, K.V., Koca, D. 2011. Challenging the planetary boundaries I: Assessing the sustainable global population and phosphate supply, using a systems dynamics assessment model. *Applied Geochemistry* 2011; 26: S311-313, doi:10.1016/j.apgeochem.2011.03.088

Sverdrup, H., Koca, D., Granath C., 2013a Modelling the gold market, explaining the past and assessing the physical and economical sustainability of future scenarios. In; Schwanninger, M., Husemann, E., and Lane, D., *Proceedings of the 30th International Conference of the System Dynamics Society*, St. Gallen, Switzerland, July 22–26, 2012. Model-based Management. University of St. Gallen, Switzerland; Systems Dynamics Society. Pages 5:4002-4023. ISBN: 9781622764143. Curran Associates, Inc.

Sverdrup, H., Koca, D., Ragnarsdottir, K.V. 2013 Peak metals, minerals, energy, wealth, food and population; urgent policy considerations for a sustainable society. *Journal of Earth Science and Engineering*. 2013; 499-534. ISSN 2159-581X

Sverdrup, H., Koca, D., Ragnarsdottir, K.V. 2014a Investigating the sustainability of the global silver supply, reserves, stocks in society and market price using different approaches. *Resources, Conservation and Recycling*. 83;121-140.

Sverdrup, H., Ragnarsdottir, K.V., Koca, D., 2014b. On modelling the global copper mining rates, market supply, copper price and the end of copper reserves. *Resources, Conservation and Recycling* 87:158-174

Sverdrup, H.U., and Ragnarsdottir, K.V., 2014c. Natural Resources in a planetary perspective. *Geochemical Perspectives Vol. 2*, number 2, October issue 2014. 2:1-156. European Geochemical Society.

Sverdrup, H., Ragnarsdottir, K.V., 2016a. The future of platinum group metal supply; An integrated dynamic modelling for platinum group metal supply, reserves, stocks-in-use, market price and sustainability. *Resources, Conservation and Recycling* 114: 130-152.

Sverdrup, H., Ragnarsdottir, K.V., 2016b Modelling the global primary extraction, supply, price and depletion of the extractable geological resources using the COBALT model. *Biophysical Economics and Resource Quality*. DOI: 10.1007/s41247-017-0017-0

Sverdrup, H., 2016. Modelling global extraction, supply, price and depletion of the extractable geological resources with the LITHIUM model. *Resources, Conservation and Recycling* 114: 112-129

Sverdrup, H., Koca, D., Ragnarsdottir K.V. 2017a. Defining a free market: Drivers of unsustainability as illustrated with an example of shrimp farming in the mangrove forest in South East Asia. *Journal of Cleaner Production*, 140;299-311, DOI: 10.1016/j.jclepro.2015.06.087

Sverdrup, H. U., Ragnarsdottir, K. V., Koca, D. 2017b. An assessment of global metal supply sustainability: Global recoverable reserves, mining rates, stocks-in-use, recycling rates, reserve sizes and time to production peak leading to subsequent metal scarcity. *Journal of Cleaner Production*, 140; 359-372, doi:10.1016/j.jclepro.2015.06.085

Sverdrup, H., Ragnarsdottir, K.V., Koca, D., 2017a. Estimating critical extraction rates for the main metals for a sustainable society within the planetary limits Proceedings of the 2015 World Resources Forum, 11-15 September. Davos, Switzerland. In: (Eds) Ludwig, C., Matasci, C., Boosting resource productivity by adopting the circular economy. Pages 77-83. Paul Scherrer Institute, Villingen, Switzerland. ISBN 978-3-9521409-7-0

Sverdrup, H., Koca, D., Schlyter, P., 2017c. A simple system dynamics model for the global production rate of sand, gravel, crushed rock and stone, market prices and long-term supply embedded into the WORLD6 model. *Biophysical Economics and Resource Quality*: 2:8, 20 pages. Doi:10.1007/s4127-017.0023-2

Sverdrup, H. U., Olafsdottir, A.H., Ragnarsdottir, K.V., 2017d. Modelling Global Wolfram Mining, Secondary Extraction, Supply, Stocks-in-Society, Recycling, Market Price and Resources, Using the WORLD6 System Dynamics Model. *Biophysical Economics and Resource Quality* 3: 4-22. DOI 10.1007/s41247-017-0028-x

Sverdrup, H., Ragnarsdottir, K.V., Koca, D., 2017. Modelling the copper, zinc and lead mining rates and co-extraction of dependent metals, supply, price and extractable amounts using the BRONZE model. Proceedings of the 2015 World Resources Forum, 11-15 September. Davos, Switzerland. In: (Eds) Ludwig, C., Matasci, C., Boosting resource productivity by adopting the circular economy. Pages 100-108. Paul Scherrer Institute, Villingen, Switzerland. ISBN 978-3-9521409-7-0

Sverdrup, H., Olafsdottir, A.H., Ragnarsdottir, K.V., Koca, D., Lorenz, U., 2018. The WORLD6 integrated system dynamics model: Examples of results from simulations. Proceedings from the 2018 World Resources Forum, Geneva, Switzerland. 11 pages.

Sverdrup H.U., Ragnarsdottir, K.V., Sverdrup, H. U., 2015d. Global challenges and systems thinking. In: *Anthropocene*, Ed: J. Blewitt, 27-46. Bristol, United Kingdom <https://goodworkspublishingcoop.wordpress.com/>

- Sverdrup H. (Ed.), Haraldsson, H., Koca, D., Belyazid, S. (1st edition), 2014, 2017 (2nd edition), (3rd edition) System Thinking, System Analysis and System Dynamics: Modelling Procedures for Communicating Insight and Understanding by Using Adaptive Learning in Engineering for Sustainability. 2st edition for Iceland. Two volumes, 20 printed. Háskolaprent Reykjavik. 310pp.
- Vennix, J.A.M., 1996. Group Model Building. Wiley, New York, 297 pp.
- Vennix, J.A.M., Akkermans, H.A. and Rouwette, A.J.A., 1996. Group model-building to facilitate organizational change: an exploratory study. *System Dynamics Review*, 12(1): 39-58.
- Vennix, J.A.M., Andersen, D., Richardson, P.G. and Rohrbaugh, J., 1992. Model-Building for Group Decision Support: Issues and alternatives in knowledge Elicitation. *European Journal of Operational Research*, 59(1): 14-28.
- Walker, W.H., Lewis, W.K. and McAdams, W.H., 1923. Principles of Chemical Engineering. McGraw-Hill, 450 pp.
- Wallman, P., 2004. Modeling nutrient cycling and sustainable forest growth in a changing world. PhD Thesis, Lund University, Lund, 150 pp.
- Wolstenholme, E.F., 1990. System Enquiry: A System Dynamic Approach. Wiley, Chichester.
- Wolstenholme, E.F. and Coyle, G.R., 1983. The Development of System Dynamics as a Methodology for System Description and Qualitative Analysis. *Journal of the Operational Research Society*, 34(7): 569-581.
- Sverdrup, H., Nihlgård, B., Svensson, M., Thelin, G., 2002. Principles of sustainable forest management. In: Eds Sverdrup, H and Stjernquist, I: Developing principles and models for sustainable forestry in Sweden; *Managing Forest Ecosystems* 5:33-56
- White A. and Brantley, S. 1995. Chemical weathering rates of silicate minerals; An overview. In Chemical weathering rates of silicate minerals; Eds A White and S. Brantley, *Reviews in Mineralogy* 31:1-22

System science and system thinking in practice

REPORT 6981

SWEDISH EPA
ISBN 978-91-620-6981-0
ISSN 0282-7298

How to develop qualitative and numerical models for evolving understandings of challenges and responses to complex policies

This publication addresses some of the challenging issues facing many public authorities in how to adopt systems science and systems thinking in their work. The text lays out a systematic approach to problem solving on a basic level by illustrating how to approach complex tasks as well as provides theoretical discussions, practical examples, project examples, and exercises. The text is written for laypeople, so the examples (i.e., case studies) used are easy to understand. The case examples demonstrate the processes required for defining a problem and creating solution(s) – i.e., systems thinking and analysis. Understanding systems thinking, system analysis, and system dynamics will provide public authorities and organisations the flexibility and agility to quickly adapt to a changing society.

